

Introduction

This programming manual provides information for application and system-level software developers. It gives a full description of the STM32F7 Series and STM32H7 Series Cortex[®]-M7 processor programming model, instruction set and core peripherals.

STM32F7 Series and STM32H7 Series Cortex-M7 processors are high-performance 32-bit processors designed for the microcontroller market.

The Arm[®] Cortex[®]-M7 is the highest-performance Cortex-M processor. It combines a six-stage, superscalar pipeline with flexible system and memory interfaces including AXI, AHB, caches and tightly-coupled memories, and delivers a high integer, floating-point and DSP performance in the STM32F7 Series and STM32H7 Series MCUs. It also supports dual-issue of load/load and load/store instruction pairs to multiple memory interfaces.

The Cortex-M7 processor takes advantage of the same easy-to-use, C friendly programmer's model and is 100% binary compatible with the existing Cortex-M processors and tools. Along with all Cortex-M series processors, it enjoys full support from the Arm Cortex-M ecosystem. The software compatibility enables a simple migration from Cortex-M3 and Cortex-M4 processors.

Contents

1	About this document	14
1.1	Typographical conventions	14
1.2	List of abbreviations for registers	14
1.3	About the Cortex [®] -M7 processor and core peripherals	15
1.3.1	System level interface	16
1.3.2	Integrated configurable debug	16
1.3.3	Cortex [®] -M7 processor features and benefits summary	17
1.3.4	Cortex [®] -M7 processor core peripherals	17
2	The Cortex-M7 processor	19
2.1	Programmers model	19
2.1.1	Processor mode and privilege levels for software execution	19
2.1.2	Stacks	19
2.1.3	Core registers	20
2.1.4	Exceptions and interrupts	28
2.1.5	Data types	29
2.1.6	The Cortex Microcontroller Software Interface Standard (CMSIS)	29
2.2	Cortex [®] -M7 configurations	30
2.3	Memory model	32
2.3.1	Memory regions, types and attributes	33
2.3.2	Memory system ordering of memory accesses	33
2.3.3	Behavior of memory accesses	34
2.3.4	Software ordering of memory accesses	36
2.3.5	Memory endianness	36
2.3.6	Synchronization primitives	37
2.3.7	Programming hints for the synchronization primitives	38
2.4	Exception model	39
2.4.1	Exception states	39
2.4.2	Exception types	39
2.4.3	Exception handlers	41
2.4.4	Vector table	42
2.4.5	Exception priorities	43
2.4.6	Interrupt priority grouping	43
2.4.7	Exception entry and return	44

2.5	Fault handling	47
2.5.1	Fault types	47
2.5.2	Fault escalation and hard faults	48
2.5.3	Synchronous and Asynchronous bus faults	49
2.5.4	Fault status registers and fault address registers	49
2.5.5	Lockup	49
2.6	Power management	50
2.6.1	Entering sleep mode	50
2.6.2	Wakeup from sleep mode	51
2.6.3	The external event input	51
2.6.4	Power management programming hints	51
3	The Cortex-M7 instruction set	52
3.1	Instruction set summary	52
3.1.1	Binary compatibility with other Cortex processors	61
3.2	CMSIS functions	62
3.3	About the instruction descriptions	63
3.3.1	Operands	63
3.3.2	Restrictions when using PC or SP	63
3.3.3	Flexible second operand	64
3.3.4	Shift operations	65
3.3.5	Address alignment	68
3.3.6	PC-relative expressions	68
3.3.7	Conditional execution	68
3.3.8	Instruction width selection	71
3.4	Memory access instructions	72
3.4.1	ADR	73
3.4.2	LDR and STR, immediate offset	73
3.4.3	LDR and STR, register offset	76
3.4.4	LDR and STR, unprivileged	77
3.4.5	LDR, PC-relative	78
3.4.6	LDM and STM	79
3.4.7	PLD	81
3.4.8	PUSH and POP	82
3.4.9	LDREX and STREX	83
3.4.10	CLREX	84

3.5	General data processing instructions	85
3.5.1	ADD, ADC, SUB, SBC, and RSB	87
3.5.2	AND, ORR, EOR, BIC, and ORN	89
3.5.3	ASR, LSL, LSR, ROR, and RRX	90
3.5.4	CLZ	91
3.5.5	CMP and CMN	92
3.5.6	MOV and MVN	93
3.5.7	MOVT	94
3.5.8	REV, REV16, REVSH, and RBIT	95
3.5.9	SADD16 and SADD8	96
3.5.10	SHADD16 and SHADD8	97
3.5.11	SHASX and SHSAX	98
3.5.12	SHSUB16 and SHSUB8	99
3.5.13	SSUB16 and SSUB8	100
3.5.14	SASX and SSAX	101
3.5.15	TST and TEQ	102
3.5.16	UADD16 and UADD8	103
3.5.17	UASX and USAX	104
3.5.18	UHADD16 and UHADD8	105
3.5.19	UHASX and UHSAX	106
3.5.20	UHSUB16 and UHSUB8	107
3.5.21	SEL	108
3.5.22	USAD8	108
3.5.23	USADA8	109
3.5.24	USUB16 and USUB8	110
3.6	Multiply and divide instructions	111
3.6.1	MUL, MLA, and MLS	112
3.6.2	UMULL, UMAAL, UMLAL	113
3.6.3	SMLA and SMLAW	115
3.6.4	SMLAD	116
3.6.5	SMLAL and SMLALD	117
3.6.6	SMLSD and SMLSLD	119
3.6.7	SMMLA and SMMLS	121
3.6.8	SMMUL	122
3.6.9	SMUAD and SMUSD	123
3.6.10	SMUL and SMULW	124
3.6.11	UMULL, UMLAL, SMULL, and SMLAL	126

3.6.12	SDIV and UDIV	127
3.7	Saturating instructions	128
3.7.1	SSAT and USAT	129
3.7.2	SSAT16 and USAT16	130
3.7.3	QADD and QSUB	131
3.7.4	QASX and QSAX	132
3.7.5	QDADD and QDSUB	133
3.7.6	UQASX and UQSAX	134
3.7.7	UQADD and UQSUB	136
3.8	Packing and unpacking instructions	137
3.8.1	PKHBT and PKHTB	138
3.8.2	SXT and UXT	139
3.8.3	SXTA and UXTA	140
3.9	Bit field instructions	141
3.9.1	BFC and BFI	142
3.9.2	SBFX and UBFX	143
3.9.3	SXT and UXT	144
3.10	Branch and control instructions	145
3.10.1	B, BL, BX, and BLX	145
3.10.2	CBZ and CBNZ	147
3.10.3	IT	148
3.10.4	TBB and TBH	150
3.11	Floating-point instructions	151
3.11.1	VABS	153
3.11.2	VADD	153
3.11.3	VCMP, VCMPE	154
3.11.4	VCVT, VCVTR between floating-point and integer	155
3.11.5	VCVT between floating-point and fixed-point	156
3.11.6	VCVTB, VCVTT	157
3.11.7	VDIV	157
3.11.8	VFMA, VFMS	158
3.11.9	VFNMA, VFNMS	159
3.11.10	VLDM	159
3.11.11	VLDR	160
3.11.12	VMLA, VMLS	161
3.11.13	VMOV immediate	162

3.11.14	VMOV register	162
3.11.15	VMOV scalar to Arm core register	163
3.11.16	VMOV Arm core register to single-precision	163
3.11.17	VMOV two Arm core registers to two single-precision registers	164
3.11.18	VMOV two Arm core registers and a double-precision register	164
3.11.19	VMOV Arm core register to scalar	165
3.11.20	VMRS	165
3.11.21	VMSR	166
3.11.22	VMUL	166
3.11.23	VNEG	167
3.11.24	VNMLA, VNMLS, VNMUL	167
3.11.25	VPOP	168
3.11.26	VPUSH	169
3.11.27	VSQRT	169
3.11.28	VSTM	170
3.11.29	VSTR	170
3.11.30	VSUB	171
3.11.31	VSEL	172
3.11.32	VMAXNM, VMINNM	172
3.11.33	VCVTA, VCVTN, VCVTP, VCVTM	173
3.11.34	VRINTR, VRINTX	173
3.11.35	VRINTA, VRINTN, VRINTP, VRINTM, VRINTZ	174
3.12	Miscellaneous instructions	175
3.12.1	BKPT	175
3.12.2	CPS	176
3.12.3	DMB	177
3.12.4	DSB	177
3.12.5	ISB	178
3.12.6	MRS	178
3.12.7	MSR	179
3.12.8	NOP	180
3.12.9	SEV	180
3.12.10	SVC	181
3.12.11	WFE	181
3.12.12	WFI	182
4	Cortex-M7 peripherals	183

4.1	About the Cortex-M7 peripherals	183
4.2	Nested Vectored Interrupt Controller	184
4.2.1	Accessing the Cortex [®] -M7 NVIC registers using CMSIS	185
4.2.2	Interrupt set-enable registers	185
4.2.3	Interrupt clear-enable registers	186
4.2.4	Interrupt set-pending registers	186
4.2.5	Interrupt clear-pending registers	187
4.2.6	Interrupt active bit registers	188
4.2.7	Interrupt priority registers	188
4.2.8	Software trigger interrupt register	189
4.2.9	Level-sensitive and pulse interrupts	190
4.2.10	NVIC design hints and tips	191
4.3	System control block	192
4.3.1	Auxiliary control register	193
4.3.2	CPUID base register	194
4.3.3	Interrupt control and state register	194
4.3.4	Vector table offset register	197
4.3.5	Application interrupt and reset control register	197
4.3.6	System control register	199
4.3.7	Configuration and control register	200
4.3.8	System handler priority registers	202
4.3.9	System handler control and state register	204
4.3.10	Configurable fault status register	205
4.3.11	HardFault status register	210
4.3.12	MemManage fault address register	211
4.3.13	BusFault address register	212
4.3.14	System control block design hints and tips	212
4.4	System timer, SysTick	212
4.4.1	SysTick control and status register	213
4.4.2	SysTick reload value register	214
4.4.3	SysTick current value register	214
4.4.4	SysTick calibration value register	215
4.4.5	SysTick design hints and tips	216
4.5	Processor features	217
4.5.1	Cache level ID register	217
4.5.2	Cache type register	218

4.5.3	Cache size ID register	219
4.5.4	Cache size selection register	220
4.6	Memory protection unit	221
4.6.1	MPU type register	223
4.6.2	MPU control register	223
4.6.3	MPU region number register	225
4.6.4	MPU region base address register	225
4.6.5	MPU region attribute and size register	226
4.6.6	MPU access permission attributes	228
4.6.7	MPU mismatch	230
4.6.8	Updating an MPU region	230
4.6.9	MPU design hints and tips	232
4.7	Floating-point unit	233
4.7.1	Coprocessor access control register	233
4.7.2	Floating-point context control register	234
4.7.3	Floating-point context address register	236
4.7.4	Floating-point status control register	236
4.7.5	Floating-point default status control register	237
4.7.6	Enabling the FPU	238
4.7.7	Enabling and clearing FPU exception interrupts	239
4.8	Cache maintenance operations	240
4.8.1	Full instruction cache operation	241
4.8.2	Instruction and data cache operations by address	241
4.8.3	Data cache operations by set-way	241
4.8.4	Cortex [®] -M7 cache maintenance operations using CMSIS	242
4.8.5	Initializing and enabling the L1-cache	242
4.8.6	Faults handling considerations	244
4.8.7	Cache maintenance design hints and tips	244
4.9	Access control	245
4.9.1	Instruction and data tightly-coupled memory control registers	246
4.9.2	AHBP control register	248
4.9.3	Auxiliary cache control register	249
4.9.4	AHB slave control register	250
4.9.5	Auxiliary bus fault status register	251
5	Revision history	253

List of tables

Table 1.	Summary of processor mode, execution privilege level, and stack use options	20
Table 2.	Core register set summary	21
Table 3.	PSR register combinations	22
Table 4.	APSR bit assignments	23
Table 5.	IPSR bit assignments	24
Table 6.	EPSR bit assignments	24
Table 7.	PRIMASK register bit assignments	26
Table 8.	FAULTMASK register bit assignments	26
Table 9.	BASEPRI register bit assignments	27
Table 10.	Control register bit assignments	27
Table 11.	STM32F746xx/STM32F756xx Cortex [®] -M7 configuration	30
Table 12.	STM32F76xxx/STM32F77xxx Cortex [®] -M7 configuration	30
Table 13.	STM32F72xxx/STM32F73xxx Cortex [®] -M7 configuration	31
Table 14.	STM32H7 Series Cortex [®] -M7 configuration	31
Table 15.	Ordering of memory accesses	34
Table 16.	Memory access behavior	34
Table 17.	Memory region shareability and cache policies	35
Table 18.	CMSIS functions for exclusive access instructions	38
Table 19.	Properties of the different exception types	40
Table 20.	Exception return behavior	46
Table 21.	Faults	47
Table 22.	Fault status and fault address registers	49
Table 23.	Cortex [®] -M7 instructions	52
Table 24.	CMSIS functions to generate some Cortex [®] -M7 processor instructions	62
Table 25.	CMSIS functions to access the special registers	63
Table 26.	Condition code suffixes	70
Table 27.	Memory access instructions	72
Table 28.	Offset ranges	75
Table 29.	Offset ranges	78
Table 30.	Data processing instructions	85
Table 31.	Multiply and divide instructions	111
Table 32.	Saturating instructions	128
Table 33.	Packing and unpacking instructions	137
Table 34.	Packing and unpacking instructions	141
Table 35.	Branch and control instructions	145
Table 36.	Branch ranges	146
Table 37.	Floating-point instructions	151
Table 38.	Miscellaneous instructions	175
Table 39.	Core peripheral register regions	183
Table 40.	NVIC register summary	184
Table 41.	CMSIS access NVIC functions	185
Table 42.	ISER bit assignments	185
Table 43.	ICER bit assignments	186
Table 44.	ISPR bit assignments	187
Table 45.	ICPR bit assignments	187
Table 46.	IABR bit assignments	188
Table 47.	IPR bit assignments	189
Table 48.	STIR bit assignments	189

Table 49.	CMSIS functions for NVIC control	191
Table 50.	Summary of the system control block registers	192
Table 51.	ACTLR bit assignments	193
Table 52.	CPUID bit assignments	194
Table 53.	ICSR bit assignments	195
Table 54.	VTOR bit assignments	197
Table 55.	AIRCR bit assignments	198
Table 56.	Priority grouping	198
Table 57.	SCR bit assignments	199
Table 58.	CCR bit assignments	201
Table 59.	System fault handler priority fields	202
Table 60.	SHPR1 register bit assignments	203
Table 61.	SHPR2 register bit assignments	203
Table 62.	SHPR3 register bit assignments	203
Table 63.	SHCSR bit assignments	204
Table 64.	MMFSR bit assignments	206
Table 65.	BFSR bit assignments	208
Table 66.	UFSR bit assignments	209
Table 67.	HFSR bit assignments	211
Table 68.	MMFAR bit assignments	211
Table 69.	BFAR bit assignments	212
Table 70.	CMSIS function for system control	212
Table 71.	System timer registers summary	213
Table 72.	SysTick SYST_CSR bit assignments	213
Table 73.	SYST_RVR bit assignments	214
Table 74.	SYST_CVR bit assignments	215
Table 75.	SYST_CALIB bit assignments	215
Table 76.	CMSIS functions for SysTick control	216
Table 77.	Identification space summary	217
Table 78.	CLIDR bit assignments	217
Table 79.	CTR bit assignments	218
Table 80.	CCSIDR bit assignments	219
Table 81.	CCSIDR encodings	220
Table 82.	CSSELR bit assignments	220
Table 83.	Memory attributes summary	221
Table 84.	MPU registers summary	222
Table 85.	TYPE bit assignments	223
Table 86.	MPU_CTRL bit assignments	224
Table 87.	MPU_RNR bit assignments	225
Table 88.	MPU_RBAR bit assignments	226
Table 89.	MPU_RASR bit assignments	227
Table 90.	Example SIZE field values	228
Table 91.	TEX, C, B, and S encoding	228
Table 92.	Cache policy for memory attribute encoding	229
Table 93.	AP encoding	229
Table 94.	Cortex [®] -M7 floating-point system registers	233
Table 95.	CPACR bit assignments	234
Table 96.	FPCCR bit assignments	234
Table 97.	FPCAR bit assignments	236
Table 98.	FPSCR bit assignments	236
Table 99.	FPDSCR bit assignments	237
Table 100.	Cache maintenance space register summary	240

Table 101.	Cache operation registers bit assignments	241
Table 102.	Cache operations by set-way bit assignments	241
Table 103.	CMSIS access cache maintenance operations	242
Table 104.	Access control register summary	245
Table 105.	ITCMCR and DTCMCR bit assignments	246
Table 106.	AHBPCR bit assignments	248
Table 107.	CACR bit assignments	249
Table 108.	AHBSCR bit assignments	250
Table 109.	ABFSR bit assignments	251
Table 110.	Document revision history	253

List of figures

Figure 1.	STM32 Cortex [®] -M7 implementation processor	15
Figure 2.	Processor core registers	20
Figure 3.	APSR, IPSR and EPSR bit assignments	22
Figure 4.	PRIMASK bit assignments:	26
Figure 5.	FAULTMASK bit assignments	26
Figure 6.	BASEPRI bit assignments	27
Figure 7.	Control bit assignments	27
Figure 8.	Processor memory map	32
Figure 9.	Little-endian format	37
Figure 10.	Vector table	42
Figure 11.	Exception stack frame	45
Figure 12.	ASR	66
Figure 13.	LSR	66
Figure 14.	LSL	67
Figure 15.	ROR	67
Figure 16.	RRX	67
Figure 17.	ISER bit assignments	185
Figure 18.	ICER bit assignment	186
Figure 19.	ISPR bit assignments	186
Figure 20.	ICPR bit assignments	187
Figure 21.	IABR bit assignments	188
Figure 22.	IPR bit assignments	188
Figure 23.	STIR bit assignments	189
Figure 24.	ACTLR bit assignments	193
Figure 25.	CPUID bit assignments	194
Figure 26.	ICSR bit assignments	195
Figure 27.	VTOR bit assignments	197
Figure 28.	AIRCR bit assignments	197
Figure 29.	SCR bit assignments:	199
Figure 30.	CCR bit assignments	200
Figure 31.	SHPR1 bit assignments	202
Figure 32.	SHPR2 bit assignments	203
Figure 33.	SHPR3 bit assignments	203
Figure 34.	SHCSR bit assignments	204
Figure 35.	CFSR bit assignments	205
Figure 36.	MMFSR bit assignments	206
Figure 37.	BFSR bit assignments	207
Figure 38.	UFSR bit assignments	209
Figure 39.	HFSR bit assignments	210
Figure 40.	SysTick SYST_CSR bit assignments	213
Figure 41.	SYST_RVR bit assignments	214
Figure 42.	SYST_CVR bit assignments:	214
Figure 43.	SYST_CALIB bit assignments	215
Figure 44.	CLIDR bit assignments	217
Figure 45.	CTR bit assignments	218
Figure 46.	CCSIDR bit assignments	219
Figure 47.	CSSELR bit assignments	220
Figure 48.	TYPE bit assignments	223

Figure 49.	MPU_CTRL bit assignments	223
Figure 50.	MPU_RNR bit assignments	225
Figure 51.	MPU_RBAR bit assignments:	225
Figure 52.	MPU_RASR bit assignments	227
Figure 53.	Example of disabling subregion	232
Figure 54.	CPACR bit assignments	233
Figure 55.	FPCCR bit assignments	234
Figure 56.	FPCAR bit assignments	236
Figure 57.	FPSCR bit assignments	236
Figure 58.	FPDSCR bit assignments	237
Figure 59.	Cache operation bit assignments	241
Figure 60.	ITCMR and DTCMR bit assignments	246
Figure 61.	AHBPCR bit assignments	248
Figure 62.	CACR bit assignments	249
Figure 63.	AHBSCR bit assignments	250
Figure 64.	ABFSR bit assignments	251

1 About this document

This document provides information required for application and system-level software development. It does not provide information on debug components, features, or operation.

STM32F7 Series and STM32H7 Series 32-bit MCUs are based on Arm^{®(a)} Cortex[®]-M processors.



This material is for microcontroller software and hardware engineers, including those who have no experience of Arm products.

1.1 Typographical conventions

The typographical conventions used in this document are:

<i>italic</i>	Highlights important notes, introduces special terminology, denotes internal cross-references, and citations.
bold	Highlights interface elements, such as menu names. Denotes signal names. Also used for terms in descriptive lists, where appropriate.
<code>monospace</code>	Denotes text that the user can enter at the keyboard, such as commands, file and program names, and source code.
<u><code>monospace</code></u>	Denotes a permitted abbreviation for a command or option. <code>core</code> can enter the underlined text instead of the full command or option name.
<i><code>monospace italic</code></i>	Denotes arguments to monospace text where the argument is to be replaced by a specific value.
<code>monospace bold</code>	Denotes language keywords when used outside example code.
< and >	Enclose replaceable terms for assembler syntax where they appear in code or code fragments. For example: LDRSB<cond> <Rt>, [<Rn>, #<offset>]

1.2 List of abbreviations for registers

The following abbreviations are used in register descriptions:

read/write (rw)	Software can read and write to these bits.
read-only (r)	Software can only read these bits.
write-only (w)	Software can only write to this bit. Reading the bit returns the reset value.
read/clear (rc_w)	Software can read as well as clear this bit by writing any value.

a. Arm is a registered trademark of Arm Limited (or its subsidiaries) in the US and/or elsewhere.

order superscalar processor delivers exceptional power efficiency through an efficient instruction set and extensively optimized design, providing high-end processing hardware including IEEE754-compliant single-precision and double-precision floating-point computation, a range of single-cycle and SIMD multiplication and multiply-with-accumulate capabilities, saturating arithmetic and dedicated hardware division.

To facilitate the design of cost-sensitive devices, the Cortex[®]-M7 processor implements tightly-coupled system components that reduce processor area while significantly improving interrupt handling and system debug capabilities. The Cortex[®]-M7 processor implements a version of the Thumb[®] instruction set based on Thumb-2 technology, ensuring high code density and reduced program memory requirements. The Cortex[®]-M7 instruction set provides the exceptional performance expected of a modern 32-bit architecture, with the high code density of 8-bit and 16-bit microcontrollers.

The Cortex[®]-M7 processor closely integrates a configurable NVIC, to deliver industry-leading interrupt performance. The NVIC includes a *Non Maskable Interrupt* (NMI), and provides up to 256 interrupt priority levels. The tight integration of the processor core and NVIC provides fast execution of *interrupt service routines* (ISRs), dramatically reducing the interrupt latency. This is achieved through the hardware stacking of registers, and the ability to suspend load-multiple and store-multiple operations. Interrupt handlers do not require wrapping in assembler code, removing any code overhead from the ISRs. A tail-chain optimization also significantly reduces the overhead when switching from one ISR to another.

To optimize low-power designs, the NVIC integrates with the sleep modes, that include a deep sleep function that enables the entire device to be rapidly powered down while still retaining program state.

The reliability is increased with automatic fault detection and handling built-in. The Cortex[®]-M7 processor uses ECC and SECDDED on accesses to memory and has *Memory Build-in Self Test* (MBIST) capability. The Cortex[®]-M7 processor is dual-redundant, which means it can operate in lock-step. The MCU vendor determines the reliability features configuration and therefore this can differ across different devices and families.

To increase instruction throughput, the Cortex[®]-M7 processor can execute certain pairs of instructions simultaneously. This is called dual issue.

1.3.1 System level interface

The Cortex[®]-M7 processor provides multiple interfaces using AMBA[®] technology to provide high speed, low latency memory accesses. It supports unaligned data accesses.

The Cortex[®]-M7 processor has an MPU that provides fine grain memory control, enabling applications to utilize multiple privilege levels, separating and protecting code, data and stack on a task-by-task basis. Such requirements are becoming critical in many embedded applications such as automotive.

1.3.2 Integrated configurable debug

The Cortex[®]-M7 processor implements a complete hardware debug solution. This provides high system visibility of the processor and memory through either a traditional JTAG port or a 2-pin *Serial Wire Debug* (SWD) port that is ideal for microcontrollers and other small package devices. The MCU vendor determines the debug feature configuration and therefore this can differ across different devices and families.

For system trace the processor integrates an *Instrumentation Trace Macrocell* (ITM) together with data watchpoints and a profiling unit. To enable simple and cost-effective profiling of the system events these generate, a *Serial Wire Viewer* (SWV) can export a stream of software-generated messages, data trace, and profiling information through a single pin.

The optional CoreSight technology components, *Embedded Trace Macrocell*[™] (ETM), delivers unrivalled instruction trace and data trace capture in an area far smaller than traditional trace units, enabling many low cost MCUs to implement full instruction trace for the first time.

The Breakpoint Unit provides up to eight hardware breakpoint comparators that debuggers can use.

1.3.3 Cortex[®]-M7 processor features and benefits summary

- Tight integration of system peripherals reduces area and development costs.
- Thumb instruction set combines high code density with 32-bit performance.
- IEEE754-compliant single-precision and double-precision *Floating-Point Unit* (FPU).
- Power control optimization of system components.
- Integrated sleep modes for low-power consumption.
- Fast code execution permits slower processor clock or increases sleep mode time.
- Hardware division and fast digital-signal-processing orientated multiply accumulate.
- Saturating arithmetic for signal processing.
- Deterministic, high-performance interrupt handling for time-critical applications.
- MPU for safety-critical applications.
- Arm Cortex[®]-M7 with instruction cache and data cache
- Memory system features such as caches, *Tightly-Coupled Memory* (TCM) with DMA port, and a high performance AXI external memory interface.
- Dedicated AHB slave (AHBS) interface for system access to TCMs
- Extensive debug and trace capabilities:
 - Serial Wire Debug and Serial Wire Trace reduce the number of pins required for debugging, tracing, and code profiling.

1.3.4 Cortex[®]-M7 processor core peripherals

The Cortex[®]-M7 processor core peripherals are:

Nested Vectored Interrupt Controller

The NVIC is an embedded interrupt controller that supports low latency interrupt processing.

System Control Block

The *System Control Block* (SCB) is the programmers model interface to the processor. It provides system implementation information and system control, including configuration, control, and reporting of system exceptions.

Integrated instruction and data caches

The instruction and data caches provide fast access to frequently accessed data and instructions, providing support for increased average performance when using system based memory.

System timer

The system timer, SysTick, is a 24-bit count-down timer. Use this as a *Real Time Operating System* (RTOS) tick timer or as a simple counter.

Memory Protection Unit

The *Memory Protection Unit* (MPU) improves system reliability by defining the memory attributes for different memory regions. It provides up to 8 different regions, and an optional predefined background region.

Floating-point unit

The FPU provides IEEE754-compliant operations on 32-bit single-precision and 64-bit double-precision floating-point values.

2 The Cortex-M7 processor

2.1 Programmers model

This section describes the Cortex[®]-M7 programmers model. In addition to the individual core register descriptions, it contains information about the processor modes and privilege levels for software execution and stacks.

2.1.1 Processor mode and privilege levels for software execution

The processor *modes* are:

Thread mode	Executes application software. The processor enters Thread mode when it comes out of reset.
Handler mode	Handles exceptions. The processor returns to Thread mode when it has finished all exception processing.

The *privilege levels* for software execution are:

Unprivileged	<p>The software:</p> <ul style="list-style-type: none">• Has limited access to system registers using the MSR and MRS instructions, and cannot use the CPS instruction to mask interrupts.• Cannot access the system timer, NVIC, or system control block.• Might have restricted access to memory or peripherals. <p><i>Unprivileged software</i> executes at the unprivileged level.</p>
Privileged	<p>The software can use all the instructions and has access to all resources.</p> <p><i>Privileged software</i> executes at the privileged level.</p>

In Thread mode, the CONTROL register controls whether software execution is privileged or unprivileged, see [CONTROL register on page 27](#). In Handler mode, software execution is always privileged.

Only privileged software can write to the CONTROL register to change the privilege level for software execution in Thread mode. Unprivileged software can use the SVC instruction to make a *supervisor call* to transfer control to privileged software.

2.1.2 Stacks

The processor uses a full descending stack. This means the stack pointer holds the address of the last stacked item in memory. When the processor pushes a new item onto the stack, it decrements the stack pointer and then writes the item to the new memory location. The processor implements two stacks, the *main stack* and the *process stack*, with a pointer for each held in independent registers, see [Stack pointer on page 21](#).

In Thread mode, the CONTROL register controls whether the processor uses the main stack or the process stack, see [CONTROL register on page 27](#). In Handler mode, the processor always uses the main stack. The options for processor operations are:

Table 1. Summary of processor mode, execution privilege level, and stack use options

Processor mode	Used to execute	Privilege level for software execution	Stack used
Thread	Applications	Privileged or unprivileged ⁽¹⁾	Main stack or process stack ⁽¹⁾
Handler	Exception handlers	Always privileged	Main stack

1. See [CONTROL register on page 27](#).

2.1.3 Core registers

The processor core registers are

Figure 2. Processor core registers

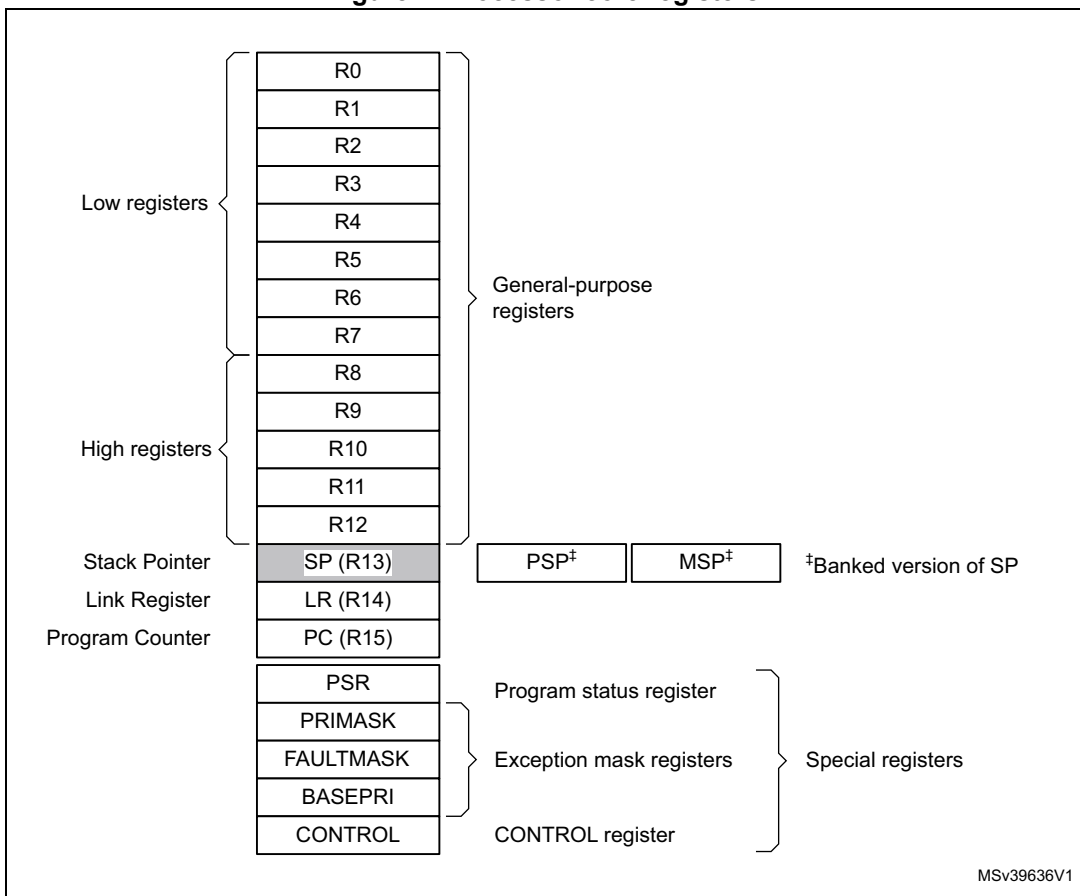

Table 2. Core register set summary

Register	Name	Type ⁽¹⁾	Required privilege ⁽²⁾	Reset value	Description
General-purpose registers	R0-R12	RW	Either	Unknown	General-purpose registers on page 21.
Stack pointer	MSP	RW	Either	See description	Stack pointer on page 21.
Stack pointer	PSP	RW	Either	Unknown	Stack pointer on page 21
Link register	LR	RW	Either	0xFFFFFFFF	Link register on page 21
Program counter	PC	RW	Either	See description	Program counter on page 22
Program status register	PSR	RW	Either	0x01000000 ⁽³⁾	Program status register on page 22
Application program status register	APSR	RW	Either	Unknown	Application program status register on page 23
Interrupt program status register	IPSR	RO	Privileged	0x00000000	Interrupt program status register on page 23
Execution program Status register	EPSR	RO	Privileged	0x01000000 ⁽³⁾	Execution program status register on page 24
Priority mask register	PRIMASK	RW	Privileged	0x00000000	Priority mask register on page 25
Fault mask register	FAULTMASK	RW	Privileged	0x00000000	Fault mask register on page 26
Base priority mask register	BASEPRIS	RW	Privileged	0x00000000	Priority mask register on page 25
Control register	CONTROL	RW	Privileged	0x00000000	CONTROL register on page 27

1. Describes access type during program execution in Thread mode and Handler mode. Debug access can differ.

2. An entry of Either means privileged and unprivileged software can access the register.

3. The EPSR reads as zero when executing an MRS instruction.

General-purpose registers

R0-R12 are 32-bit general-purpose registers for data operations.

Stack pointer

The *Stack Pointer* (SP) is register R13. In Thread mode, bit[1] of the CONTROL register indicates the stack pointer to use:

- 0 = *Main Stack Pointer* (MSP). This is the reset value.
- 1 = *Process Stack Pointer* (PSP).

On reset, the processor loads the MSP with the value from address 0x00000000.

Link register

The *Link Register* (LR) is register R14. It stores the return information for subroutines, function calls, and exceptions. On reset, the processor sets the LR value to 0xFFFFFFFF.

Program counter

The *Program Counter* (PC) is register R15. It contains the current program address. On reset, the processor loads the PC with the value of the reset vector, which is at address 0x00000004. Bit[0] of the value is loaded into the EPSR T-bit at reset and must be 1.

Program status register

The *Program Status register* (PSR) combines:

- *Application Program Status register* (APSR).
- *Interrupt Program Status register* (IPSR).
- *Execution Program Status register* (EPSR).

These registers are mutually exclusive bit fields in the 32-bit PSR. The bit assignments are

Figure 3. APSR, IPSR and EPSR bit assignments

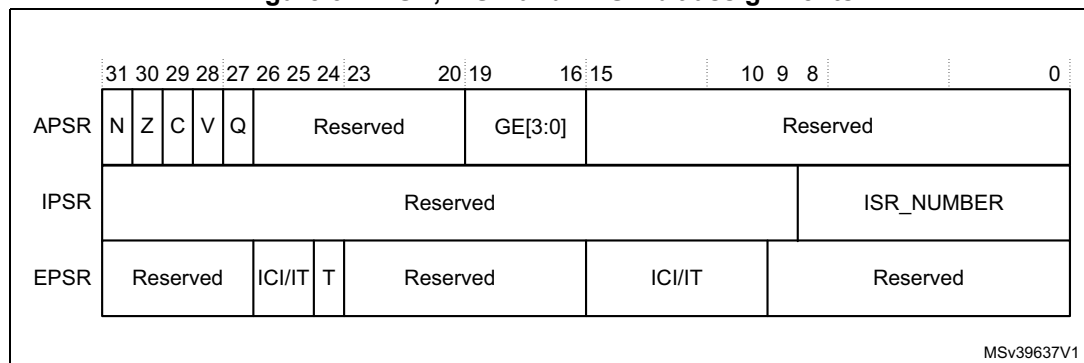

Access these registers individually or as a combination of any two or all three registers, using the register name as an argument to the MSR or MRS instructions. For example:

- Read all of the registers using PSR with the MRS instruction.
- Write to the APSR N, Z, C, V, and Q bits using APSR_nzcvq with the MSR instruction.

The PSR combinations and attributes are:

Table 3. PSR register combinations

Register	Type	Combination
PSR	RW ^{(1),(2)}	APSR, EPSR, and IPSR.
IEPSR	RO	EPSR and IPSR.
IAPSR	RW ⁽¹⁾	APSR and IPSR.
EAPSR	RW ⁽²⁾	APSR and EPSR.

1. The processor ignores writes to the IPSR bits.
2. Reads of the EPSR bits return zero, and the processor ignores writes to these bits.

See the instruction descriptions [MRS on page 178](#) and [MSR on page 179](#) for more information about how to access the program status registers.

Application program status register

The APSR contains the current state of the condition flags from previous instruction executions. See the register summary in [Table 4 on page 23](#) for its attributes. The bit assignments are:

Table 4. APSR bit assignments

Bits	Name	Description
[31]	N	Negative flag.
[30]	Z	Zero flag.
[29]	C	Carry or borrow flag.
[28]	V	Overflow flag.
[27]	Q	DSP overflow and saturation flag
[26:20]	-	Reserved
[19:16]	GE[3:0]	Greater than or Equal flags. See SEL on page 108 for more information.
[15:0]	-	Reserved

Interrupt program status register

The IPSR contains the exception type number of the current *Interrupt Service Routine* (ISR). See the register summary in [Table 5 on page 24](#) for its attributes. The bit assignments are:

Table 5. IPSR bit assignments

Bits	Name	Function
[31:9]	-	Reserved
[8:0]	ISR_NUMBER	This is the number of the current exception: 0 = Thread mode. 1 = Reserved. 2 = NMI. 3 = HardFault. 4 = MemManage. 5 = BusFault 6 = UsageFault 7-10 = Reserved 11 = SVCcall. 12 = Reserved for debug 13 = Reserved 14 = PendSV. 15 = SysTick. 16 = IRQ0. . . 256 = IRQ239. see Exception types on page 39 for more information.

Execution program status register

The EPSR contains the Thumb state bit, and the execution state bits for either the:

- *If-Then* (IT) instruction.
- *Interruptible-Continuable Instruction* (ICI) field for an interrupted load multiple or store multiple instruction.

See the register summary in [Table 6 on page 24](#) for the EPSR attributes. The bit assignments are

Table 6. EPSR bit assignments

Bits	Name	Function
[31:27]	-	Reserved.
[26:25], [15:10]	ICI	Interruptible-continuable instruction bits, see Interruptible-continuable instructions on page 25 .
[26:25], [15:10]	IT	Indicates the execution state bits of the IT instruction, see IT on page 148 .
[24]	T	Thumb state bit, see Thumb state .
[23:16]	-	Reserved.
[9:0]	-	Reserved.

The attempts to read the EPSR directly through application software using the MSR instruction always return zero. The attempts to write the EPSR using the MSR instruction in application software are ignored.

Interruptible-continuable instructions

When an interrupt occurs during the execution of an LDM, STM, PUSH, POP, VLDM, VSTM, V PUSH, or VPOP instruction, the processor:

- Stops the load multiple or store multiple instruction operation temporarily.
- Stores the next register operand in the multiple operation to EPSR bits[15:12].

After servicing the interrupt, the processor:

- Returns to the register pointed to by bits[15:12].
- Resumes execution of the multiple load or store instruction.

When the EPSR holds ICI execution state, bits[26:25,11:10] are zero.

If-Then block

The If-Then block contains up to four instructions following an IT instruction. Each instruction in the block is conditional. The conditions for the instructions are either all the same, or some can be the inverse of others. See [IT on page 148](#) for more information.

Thumb state

The Cortex[®]-M7 processor only supports execution of instructions in Thumb state. The following can clear the T bit to 0:

- Instructions BLX, BX and POP{PC}.
- Restoration from the stacked xPSR value on an exception return.
- Bit[0] of the vector value on an exception entry or reset.

Attempting to execute instructions when the T bit is 0 results in a fault or lockup. See [Lockup on page 49](#) for more information.

Exception mask registers

The exception mask registers disable the handling of exceptions by the processor. Disable exceptions where they might impact on timing critical tasks.

To access the exception mask registers use the MSR and MRS instructions, or the CPS instruction to change the value of PRIMASK or FAULTMASK. See [MRS on page 178](#), [MSR on page 179](#), and [CPS on page 176](#) for more information.

Priority mask register

The PRIMASK register prevents the activation of all exceptions with a configurable priority. See the register summary in [Table 7](#) for its attributes. The bit assignments are

Figure 4. PRIMASK bit assignments:

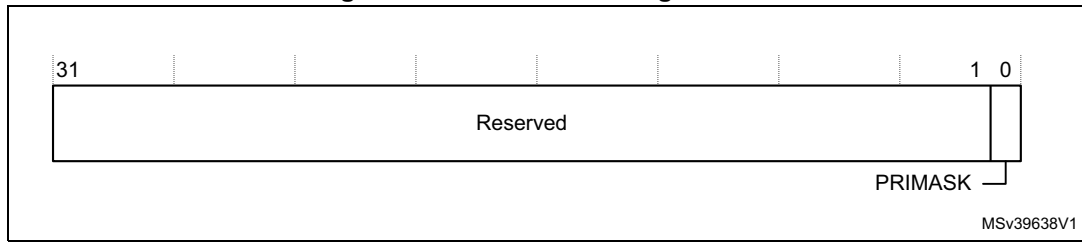

Table 7. PRIMASK register bit assignments

Bits	Name	Function
[31:1]	-	Reserved.
[0]	PRIMASK	Prioritizable interrupt mask: 0 = No effect. 1 = Prevents the activation of all exceptions with configurable priority.

Fault mask register

The FAULTMASK register prevents activation of all exceptions except for *Non Maskable Interrupt* (NMI). See the register summary in [Table 8 on page 26](#) for its attributes. The bit assignments are

Figure 5. FAULTMASK bit assignments

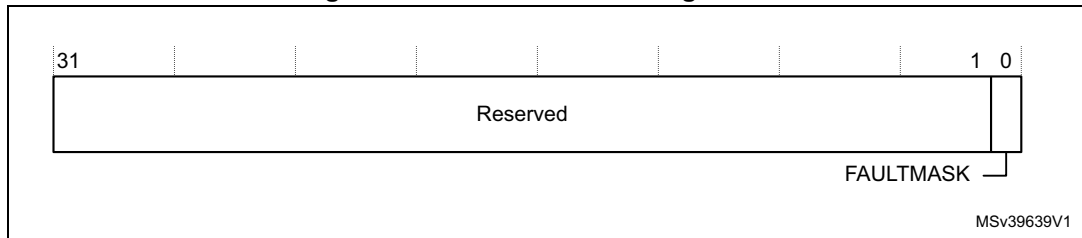

Table 8. FAULTMASK register bit assignments

Bits	Name	Function
[31:1]	-	Reserved.
[0]	FAULTMASK	Prioritizable interrupt mask: 0 = No effect. 1 = Prevents the activation of all exceptions except for NMI.

The processor clears the FAULTMASK bit to 0 on exit from any exception handler except the NMI handler.

Base priority mask register

The BASEPRI register defines the minimum priority for exception processing. When BASEPRI is set to a nonzero value, it prevents the activation of all exceptions with the same or lower priority level as the BASEPRI value. See the register summary in [Table 9 on page 27](#) for its attributes. The bit assignments are:

Figure 6. BASEPRI bit assignments

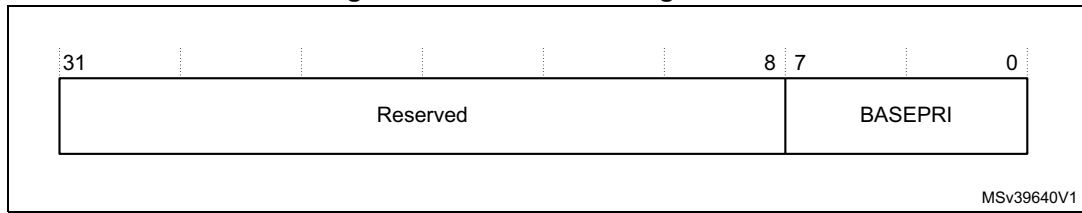

Table 9. BASEPRI register bit assignments

Bits	Name	Function
[31:8]	-	Reserved.
[7:0]	BASEPRI ⁽¹⁾	Priority mask bits: 0x00 No effect Nonzero: Defines the base priority for exception processing. The processor does not process any exception with a priority value greater than or equal to BASEPRI.

1. This field is similar to the priority fields in the interrupt priority registers. The device implements only bits[7:M] of this field, bits[M-1:0] read as zero and ignore writes. See [Interrupt program status register on page 23](#) for more information. Remember that higher priority field values correspond to lower exception priorities.

CONTROL register

The CONTROL register controls the stack used and the privilege level for software execution when the processor is in Thread mode and indicates whether the FPU state is active. See the register summary in [Table 10 on page 27](#) for its attributes. The bit assignments are:

Figure 7. Control bit assignments

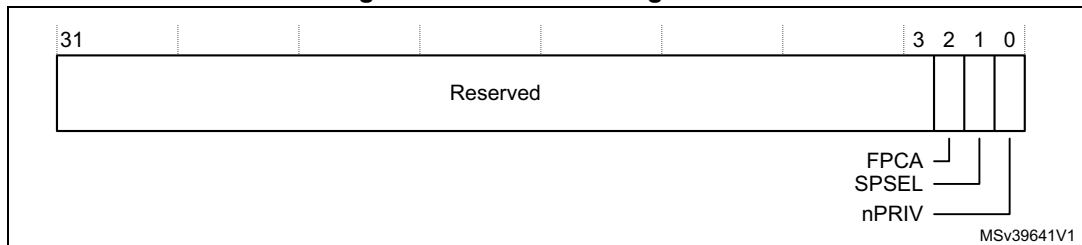

Table 10. Control register bit assignments

Bits	Name	Function
[31:3]	-	Reserved.
[2]	FPCA	Indicates whether floating-point context is currently active: 0: No floating-point context active. 1: Floating-point context active. This bit is used to determine whether to preserve floating-point state when processing an exception.

Table 10. Control register bit assignments (continued)

Bits	Name	Function
[1]	SPSEL	Defines the currently active stack pointer: 0 = MSP is the current stack pointer. 1 = PSP is the current stack pointer. In Handler mode this bit reads as zero and ignores writes. The Cortex [®] -M7 processor updates this bit automatically on exception return.
[0]	nPRIV	Defines the Thread mode privilege level: 0 = Privileged. 1 = Unprivileged.

Handler mode always uses the MSP, so the processor ignores explicit writes to the active stack pointer bit of the CONTROL register when in Handler mode. The exception entry and return mechanisms automatically update the CONTROL register based on the EXC_RETURN value, see [Table 20 on page 46](#).

In an OS environment, Arm recommends that threads running in Thread mode use the process stack and the kernel and exception handlers use the main stack.

By default, Thread mode uses the MSP. To switch the stack pointer used in Thread mode to the PSP, either:

- Use the MSR instruction to set the CONTROL.SPSELbit, the current active stack pointer bit, to 1, see [MSR on page 179](#).
- Perform an exception return to Thread mode with the appropriate EXC_RETURN value, see [Table 20 on page 46](#).

When changing the stack pointer, software must use an ISB instruction immediately after the MSR instruction. This ensures that instructions after the ISB instruction execute using the new stack pointer. See [ISB on page 178](#).

2.1.4 Exceptions and interrupts

The Cortex[®]-M7 processor supports interrupts and system exceptions. The processor and the NVIC prioritize and handle all exceptions. An exception changes the normal flow of software control. The processor uses Handler mode to handle all exceptions except for reset. See [Exception entry on page 44](#) and [Exception return on page 46](#) for more information.

The NVIC registers control interrupt handling. See [Nested Vectored Interrupt Controller on page 184](#) for more information.

2.1.5 Data types

The processor:

- Supports the following data types:
 - 32-bit words.
 - 16-bit halfwords.
 - 8-bit bytes.
 - 32-bit single-precision floating point numbers.
 - 64-bit double-precision floating point numbers.
- Manages all data memory accesses as little-endian. See [Memory regions, types and attributes on page 33](#) for more information.

2.1.6 The Cortex Microcontroller Software Interface Standard (CMSIS)

For a Cortex[®]-M7 microcontroller system, the *Cortex Microcontroller Software Interface Standard* (CMSIS) defines:

- A common way to:
 - Access peripheral registers.
 - Define exception vectors.
- The names of:
 - The registers of the core peripherals.
 - The core exception vectors.
- A device-independent interface for RTOS kernels, including a debug channel.

The CMSIS includes address definitions and data structures for the core peripherals in the Cortex[®]-M7 processor.

CMSIS simplifies software development by enabling the reuse of template code and the combination of CMSIS-compliant software components from various middleware vendors. Software vendors can expand the CMSIS to include their peripheral definitions and access functions for those peripherals.

This document includes the register names defined by the CMSIS, and gives short descriptions of the CMSIS functions that address the processor core and the core peripherals.

This document uses the register short names defined by the CMSIS. In a few cases these differ from the architectural short names that might be used in other documents.

The following sections give more information about the CMSIS:

- [Power management programming hints on page 51](#).
- [CMSIS functions on page 62](#).
- [SysTick design hints and tips on page 216](#)
- [Accessing the Cortex[®]-M7 NVIC registers using CMSIS on page 185](#).
- [NVIC programming hints on page 191](#).
- [Cortex[®]-M7 cache maintenance operations using CMSIS on page 242](#)

2.2 Cortex[®]-M7 configurations

[Table 11](#), [Table 12](#) and [Table 13](#) show the configurations for STM32F7 Series Cortex-M7.

Table 11. STM32F746xx/STM32F756xx Cortex[®]-M7 configuration

Features	STM32F746xx/STM32F756xx
Floating Point Unit	Single precision floating point unit
MPU	8 regions
Instruction TCM size	Flash TCM: 1 Mbyte RAM ITCM: 16 Kbytes
Data TCM size	64 Kbytes
Instruction cache size	4 Kbytes
Data cache size	4 Kbytes
Cache ECC	Not implemented
Interrupt priority levels	16 priority levels
Number of IRQ	98
WIC, CTI	Not implemented
Debug	JTAG & Serial-Wire Debug Ports 8 breakpoints and 4 watchpoints.
ITM support	Data Trace (DWT), and instrumentation trace (ITM)
ETM support	Instruction Trace interface

Table 12. STM32F76xxx/STM32F77xxx Cortex[®]-M7 configuration

Features	STM32F76xxx/STM32F77xxx
Floating Point Unit	Double and single precision floating point unit
MPU	8 regions
Instruction TCM size	Flash TCM: 2 Mbytes RAM ITCM: 16 Kbytes
Data TCM size	128 Kbytes
Instruction cache size	16 Kbytes
Data cache size	16 Kbytes
Cache ECC	Not implemented
Interrupt priority levels	16 priority levels
Number of IRQ	110
WIC, CTI	Not implemented
Debug	JTAG & Serial-Wire Debug Ports 8 breakpoints and 4 watchpoints.
ITM support	Data Trace (DWT), and instrumentation trace (ITM)
ETM support	Instruction Trace interface

Table 13. STM32F72xxx/STM32F73xxx Cortex[®]-M7 configuration

Features	STM32F72xxx/STM32F73xxx
Floating Point Unit	Single precision floating point unit
MPU	8 regions
Instruction TCM size	Flash TCM: 512 Kbytes RAM ITCM: 16 Kbytes
Data TCM size	64 Kbytes
Instruction cache size	8 Kbytes
Data cache size	8 Kbytes
Cache ECC	Not implemented
Interrupt priority levels	16 priority levels
Number of IRQ	104
WIC, CTI	Not implemented
Debug	JTAG & Serial-Wire Debug Ports 8 breakpoints and 4 watchpoints.
ITM support	Data Trace (DWT), and instrumentation trace (ITM)
ETM support	Instruction Trace interface

Table 14 shows the configurations for STM32H7 Series Cortex-M7.

Table 14. STM32H7 Series Cortex[®]-M7 configuration

Features	STM32H7 Series
Floating Point Unit	Double and single precision floating point unit
MPU	16 regions
Instruction TCM size	RAM ITCM: 64 Kbytes
Data TCM size	128 Kbytes
Instruction cache size	16 Kbytes
Data cache size	16 Kbytes
Cache ECC	Implemented
Interrupt priority levels	16 priority levels
Number of IRQ	149
WIC, CTI	WIC Not implemented, CTI implemented
Debug	JTAG & Serial-Wire Debug Ports 8 breakpoints and 4 watchpoints.
ITM support	Data Trace (DWT), and instrumentation trace (ITM)
ETM support	Instruction Trace interface

2.3 Memory model

This section describes the processor memory map and the behavior of memory accesses. The processor has a fixed default memory map that provides up to 4 Gbytes of addressable memory. The memory map is:

Figure 8. Processor memory map

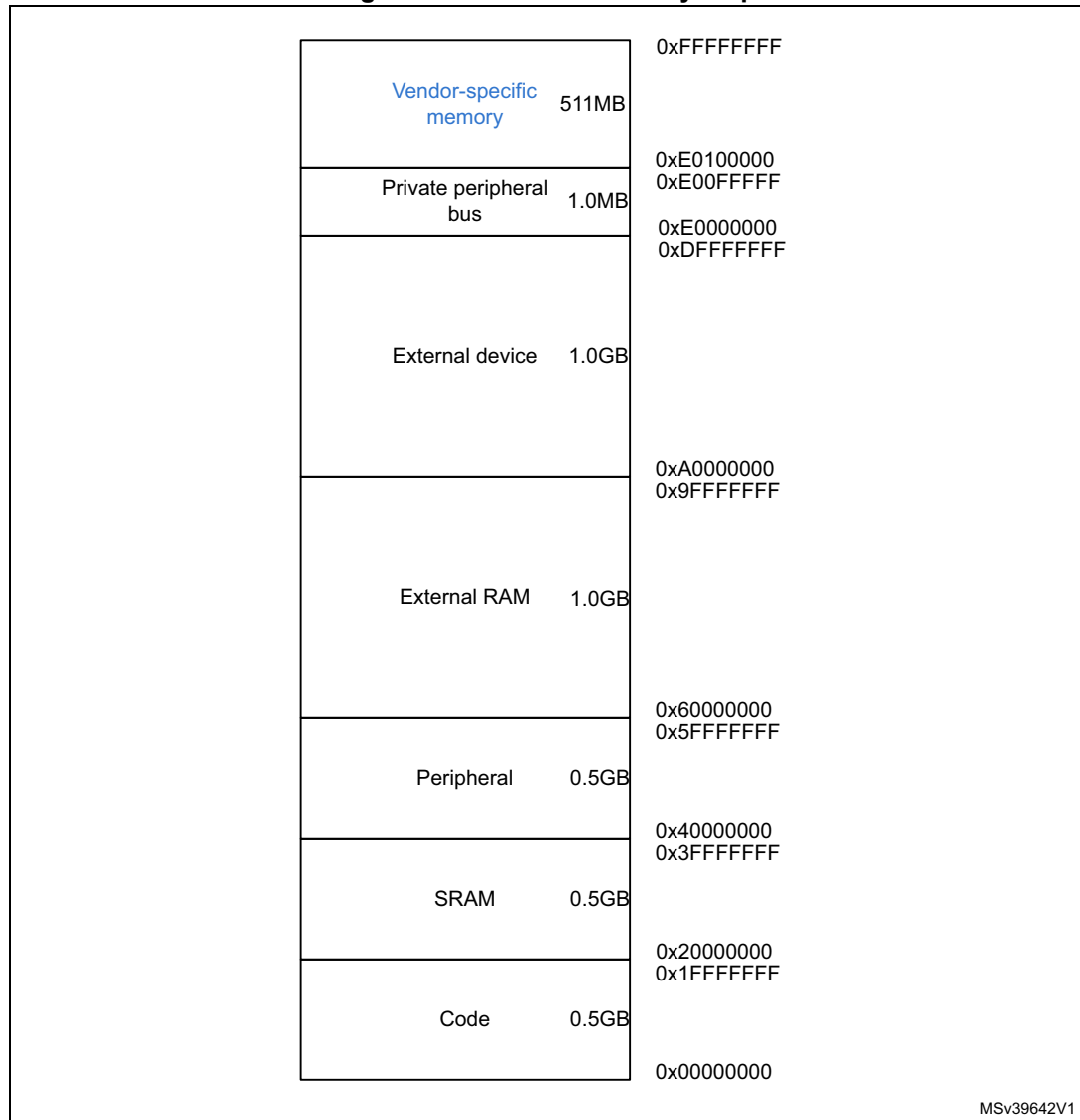

The processor reserves regions of the *Private peripheral bus* (PPB) address range for core peripheral registers, see [About the Cortex-M7 peripherals on page 183](#).

2.3.1 Memory regions, types and attributes

The memory map and the programming of the MPU split the memory map into regions. Each region has a defined memory type, and some regions have additional memory attributes. The memory type and attributes determine the behavior of accesses to the region.

The memory types are:

Normal The processor can re-order transactions for efficiency, or perform speculative reads.

Device and Strongly-ordered The processor preserves transaction order relative to other transactions to Device or Strongly-ordered memory.

The different ordering requirements for Device and Strongly-ordered memory mean that the memory system can buffer a write to Device memory, but must not buffer a write to Strongly-ordered memory.

The additional memory attributes include.

Shareable For a shareable memory region, the memory system provides data synchronization between bus masters in a system with multiple bus masters, for example, a processor with a DMA controller.

Strongly-ordered memory is always shareable.

If multiple bus masters can access a non-shareable memory region, software must ensure data coherency between the bus masters.

Execute Never (XN) Means the processor prevents instruction accesses. A HardFault exception is generated on executing an instruction fetched from an XN region of memory.

2.3.2 Memory system ordering of memory accesses

For most of memory accesses caused by explicit memory access instructions, the memory system does not guarantee that the order in which the accesses complete, matches the program order of the instructions. Providing any re-ordering does not affect the behavior of the instruction sequence. Normally, if a correct program execution depends on two memory accesses completing in the program order, the software must insert a memory barrier instruction between the memory access instructions, see [2.3.4: Software ordering of memory accesses on page 36](#).

However, the memory system does guarantee some ordering of accesses to Device and Strongly-ordered memory. For two memory access instructions A1 and A2, if A1 occurs before A2 in the program order, the ordering of the memory accesses caused by two instructions is:

Table 15. Ordering of memory accesses⁽¹⁾

A1	A2			
	Normal access	Device access		Strongly ordered access
		Non-shareable	Shareable	
Normal access	-	-	-	-
Device access, non-shareable	-	<	-	<
Device access, shareable	-	-	<	<
Strongly ordered access	-	<	<	<

- means that the memory system does not guarantee the ordering of the accesses.
 < means that accesses are observed in program order, that is, A1 is always observed before A2.

2.3.3 Behavior of memory accesses

The behavior of accesses to each region in the memory map is:

Table 16. Memory access behavior⁽¹⁾

Address range	Memory region	Memory type	XN	Description
0x00000000-0x1FFFFFFF	Code	Normal	-	Executable region for program code. The user can also put data here. Instruction fetches and data accesses are performed over the ITCM or AXIM interface.
0x20000000-0x3FFFFFFF	SRAM	Normal	-	Executable region for data. The user can also put code here. Instruction fetches and data accesses are performed over the DTCM or AXIM interface.
0x40000000-0x5FFFFFFF	Peripheral	Device	XN	External device memory. Data accesses are performed over the AHBP or AXIM interface.
0x60000000-0x9FFFFFFF	External RAM	Normal	-	Executable region for data. Instruction fetches and data accesses are performed over the AXIM interface.
0xA0000000-0xDFFFFFFF	External device	Device	XN	External device memory. Instruction fetches and data accesses are performed over the AXIM interface.
0xE0000000-0xE00FFFFF	Private Peripheral Bus	Strongly-ordered	XN	This region includes the NVIC, System timer, and System Control Block. Only word accesses can be used in this region.
0xE0100000-0xFFFFFFFF	Vendor-specific device	Device	XN	Accesses to this region are to vendor-specific peripherals.

- See [Memory regions, types and attributes on page 33](#) for more information.

The Code, SRAM, and external RAM regions can hold programs.

The MPU can override the default memory access behavior described in this section. For more information, see [Memory protection unit on page 221](#).

Additional memory access constraints for caches and shared memory

When a system includes caches or shared memory, some memory regions have additional access constraints, and some regions are subdivided, as [Table 17](#) shows:

Table 17. Memory region shareability and cache policies

Address range	Memory region	Memory type ⁽¹⁾	Shareability ⁽¹⁾	Cache policy ⁽²⁾
0x00000000-0x1FFFFFFF	Code	Normal	Non-shareable	WT
0x20000000-0x3FFFFFFF	SRAM	Normal	Non-shareable	WBWA
0x40000000-0x5FFFFFFF	Peripheral	Device	Non-shareable	-
0x60000000-0x7FFFFFFF	External RAM	Normal	Non-shareable	-
0x80000000-0x9FFFFFFF				WT
0xA0000000-0xBFFFFFFF	External device	Device	Shareable	-
0xC0000000-0xDFFFFFFF			Non-shareable	
0xE0000000-0xE0FFFFFF	Private Peripheral Bus	Strongly- ordered	Shareable	-
0xE0100000-0xFFFFFFFF	Vendor-specific device	Device	Non-shareable	-

1. See [Section 2.3.1: Memory regions, types and attributes on page 33](#) for more information.

2. WT = Write through, no write allocate. WBWA = Write back, write allocate.

Instruction prefetch and branch prediction

The Cortex[®]-M7 processor:

- Prefetches instructions ahead of execution.
- Speculatively prefetches from branch target addresses.

2.3.4 Software ordering of memory accesses

The order of instructions in the program flow does not always guarantee the order of the corresponding memory transactions. This is because:

- The processor can reorder some memory accesses to improve efficiency, providing this does not affect the behavior of the instruction sequence.
- The processor has multiple bus interfaces.
- Memory or devices in the memory map have different wait states.
- Some memory accesses are buffered or speculative.

[Memory system ordering of memory accesses on page 33](#) describes the cases where the memory system guarantees the order of memory accesses. Otherwise, if the order of memory accesses is critical, software must include memory barrier instructions to force that ordering. The processor provides the following memory barrier instructions:

DMB	The Data Memory Barrier (DMB) instruction ensures that outstanding memory transactions complete before subsequent memory transactions. See DMB on page 177 .
DSB	The Data Synchronization Barrier (DSB) instruction ensures that outstanding memory transactions complete before subsequent instructions execute. See DSB on page 177 .
ISB	The Instruction Synchronization Barrier (ISB) ensures that the effect of all completed memory transactions is recognizable by subsequent instructions. See ISB on page 178 .

MPU programming

Use a DSB, followed by an ISB instruction or exception return to ensure that the new MPU configuration is used by subsequent instructions.

2.3.5 Memory endianness

The processor views memory as a linear collection of bytes numbered in ascending order from zero. For example, bytes 0-3 hold the first stored word, and bytes 4-7 hold the second stored word. [Little-endian format on page 36](#) describes how words of data are stored in memory.

Little-endian format

In little-endian format, the processor stores the least significant byte of a word at the lowest-numbered byte, and the most significant byte at the highest-numbered byte. For example:

Figure 9. Little-endian format

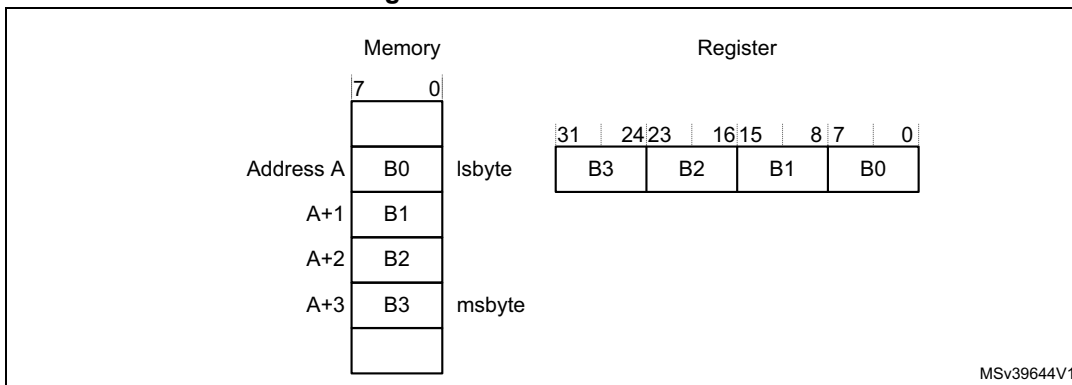

2.3.6 Synchronization primitives

The instruction set support for the Cortex[®]-M7 processor includes pairs of *synchronization primitives*. These provide a non-blocking mechanism that a thread or process can use to obtain exclusive access to a memory location. Software can use them to perform a guaranteed read-modify-write memory update sequence, or for a semaphore mechanism.

A pair of synchronization primitives comprises:

A Load-Exclusive instruction

Used to read the value of a memory location, requesting exclusive access to that location.

A Store-Exclusive instruction

Used to attempt to write to the same memory location, returning a status bit to a register. If this bit is:

- 0 it indicates that the thread or process gained exclusive access to the memory, and the write succeeds,
- 1 it indicates that the thread or process did not gain exclusive access to the memory, and no write was performed.

The pairs of Load-Exclusive and Store-Exclusive instructions are:

- The word instructions LDREX and STREX.
- The halfword instructions LDREXH and STREXH.
- The byte instructions LDREXB and STREXB.

Software must use a Load-Exclusive instruction with the corresponding Store-Exclusive instruction.

To perform an exclusive read-modify-write of a memory location, software must:

1. Use a Load-Exclusive instruction to read the value of the location.
2. Modify the value, as required.
3. Use a Store-Exclusive instruction to attempt to write the new value back to the memory location.
4. Test the returned status bit. If this bit is:
 - 0: The read-modify-write completed successfully.
 - 1: No write was performed. This indicates that the value returned at step 1 might be out of date. The software must retry the entire read-modify-write sequence.

Software can use the synchronization primitives to implement a semaphore as follows:

1. Use a Load-Exclusive instruction to read from the semaphore address to check whether the semaphore is free.
2. If the semaphore is free, use a Store-Exclusive to write the claim value to the semaphore address.
3. If the returned status bit from step 2 indicates that the Store-Exclusive succeeded then the software has claimed the semaphore. However, if the Store-Exclusive failed, another process might have claimed the semaphore after the software performed step 1.

The Cortex[®]-M7 processor includes an exclusive access monitor, that tags the fact that the processor has executed a Load-Exclusive instruction. If the processor is part of a multiprocessor system and the address is in a shared region of memory, the system also globally tags the memory locations addressed by exclusive accesses by each processor.

The processor removes its exclusive access tag if:

- It executes a CLREX instruction.
- It executes a STREX instruction, regardless of whether the write succeeds.
- An exception occurs. This means the processor can resolve semaphore conflicts between different threads.

In a multiprocessor implementation:

- Executing a CLREX instruction removes only the local exclusive access tag for the processor.
- Executing a STREX instruction, or an exception, removes the local exclusive access tags for the processor.
- Executing a STREX instruction to a shared memory region can also remove the global exclusive access tags for the processor in the system.

For more information about the synchronization primitive instructions, see [LDREX and STREX on page 83](#) and [CLREX on page 84](#).

2.3.7 Programming hints for the synchronization primitives

ISO/IEC C cannot directly generate the exclusive access instructions. CMSIS provides intrinsic functions for generation of these instructions:

Table 18. CMSIS functions for exclusive access instructions

Instruction	CMSIS function
LDREX	uint32_t __LDREXW (uint32_t *addr)
LDREXH	uint16_t __LDREXH (uint16_t *addr)
LDREXB	uint8_t __LDREXB (uint8_t *addr)
STREX	uint32_t __STREXW (uint32_t value, uint32_t *addr)
STREXH	uint32_t __STREXH (uint16_t value, uint16_t *addr)
STREXB	uint32_t __STREXB (uint8_t value, uint8_t *addr)
CLREX	void __CLREX (void)

For example:

```
uint16_t value;
uint16_t *address = 0x20001002;
value = __LDREXH (address); // load 16-bit value from memory address
0x20001002
```

2.4 Exception model

This section describes the exception model. It describes:

- [Exception states.](#)
- [Exception types.](#)
- [Exception handlers on page 41.](#)
- [Vector table on page 42.](#)
- [Exception priorities on page 43.](#)
- [Interrupt priority grouping on page 43.](#)
- [Exception entry and return on page 44.](#)

2.4.1 Exception states

Each exception is in one of the following states:

Inactive	The exception is not active and not pending.
Pending	The exception is waiting to be serviced by the processor. An interrupt request from a peripheral or from software can change the state of the corresponding interrupt to pending.
Active	An exception that is being serviced by the processor but has not completed. <i>Note: An exception handler can interrupt the execution of another exception handler. In this case both exceptions are in the active state.</i>
Active and pending	The exception is being serviced by the processor and there is a pending exception from the same source.

2.4.2 Exception types

The exception types are:

Reset	Reset is invoked on power up or a warm reset. The exception model treats reset as a special form of exception. When reset is asserted, the operation of the processor stops, potentially at any point in an instruction. When reset is deasserted, execution restarts from the address provided by the reset entry in the vector table. Execution restarts as privileged execution in Thread mode.
--------------	--

- NMI** *A NonMaskable Interrupt (NMI)* can be signalled by a peripheral or triggered by software. This is the highest priority exception other than reset. It is permanently enabled and has a fixed priority of -2. NMIs cannot be:

 - Masked or prevented from activation by any other exception.
 - Preempted by any exception other than Reset.

- HardFault** A HardFault is an exception that occurs because of an error during normal or exception processing. HardFaults have a fixed priority of -1, meaning they have higher priority than any exception with configurable priority.

- SVCall** A *Supervisor Call (SVC)* is an exception that is triggered by the SVC instruction. In an OS environment, applications can use SVC instructions to access OS kernel functions and device drivers.

- PendSV** PendSV is an interrupt-driven request for system-level service. In an OS environment, use PendSV for context switching when no other exception is active.

- SysTick** A SysTick exception is an exception the system timer generates when it reaches zero. Software can also generate a SysTick exception. In an OS environment, the processor can use this exception as system tick.

- Interrupt (IRQ)** An interrupt, or IRQ, is an exception signalled by a peripheral, or generated by a software request. All interrupts are asynchronous to instruction execution. In the system, peripherals use interrupts to communicate with the processor.

Table 19. Properties of the different exception types

Exception number ⁽¹⁾	IRQ number ⁽¹⁾	Exception type	Priority	Vector address ⁽²⁾	Activation
1	-	Reset	-3, the highest	0x00000004	Asynchronous
2	-14	NMI	-2	0x00000008	Asynchronous
3	-13	HardFault	-1	0x0000000C	Synchronous
4	-12	MemManage	Configurable ⁽³⁾	0x00000010	Synchronous
5	-11	BusFault	Configurable ⁽³⁾	0x00000014	Synchronous when precise, asynchronous when imprecise
6	-10	UsageFault	Configurable ⁽³⁾	0x00000018	Synchronous
7-10	-	Reserved	-	-	-
11	-5	SVCall	Configurable ⁽³⁾	0x0000002C	Synchronous
12-13	-	Reserved	-	-	-
14	-2	PendSV	Configurable ⁽³⁾	0x00000038	Asynchronous

Table 19. Properties of the different exception types (continued)

Exception number ⁽¹⁾	IRQ number ⁽¹⁾	Exception type	Priority	Vector address ⁽²⁾	Activation
15	-1	SysTick	Configurable ⁽³⁾	0x0000003C	Asynchronous
15	-	Reserved	-	-	-
16 and above	0 and above	Interrupt (IRQ)	Configurable ⁽⁴⁾	0x00000040 and above ⁽⁵⁾	Asynchronous

1. To simplify the software layer, the CMSIS only uses IRQ numbers. It uses negative values for exceptions other than interrupts. The IPSR returns the Exception number, see [Interrupt program status register on page 23](#)
2. See [Figure 10: Vector table on page 42](#) for more information.
3. See [System handler priority registers on page 202](#).
4. See [Interrupt priority registers on page 188](#)
5. Increasing in step of 4.

For an asynchronous exception, other than reset, the processor can execute additional instructions between when the exception is triggered and when the processor enters the exception handler.

Privileged software can disable the exceptions that [Table 19 on page 40](#) shows as having configurable priority, see:

- [System handler control and state register on page 204](#)
- [Interrupt clear-enable registers on page 186](#).

For more information about HardFaults, MemManage faults, BusFaults, and UsageFaults, see [Section 2.5: Fault handling on page 47](#)

2.4.3 Exception handlers

The processor handles exceptions using:

Interrupt Service Routines (ISRs) Interrupts IRQ0 to IRQ239 are the exceptions handled by ISRs

Fault handler HardFault, MemManage fault, UsageFault, and BusFault are fault exceptions handled by the fault handler.s

System handlers NMI, PendSV, SVC, SysTick, and the fault exceptions are all system exceptions handled by system handlers.

2.4.4 Vector table

The vector table contains the reset value of the stack pointer, and the start addresses, also called exception vectors, for all exception handlers. [Figure 10 on page 42](#) shows the order of the exception vectors in the vector table. The least-significant bit of each vector must be 1, indicating that the exception handler is Thumb code, see [Thumb state on page 25](#).

Figure 10. Vector table

Exception number	IRQ number	Offset	Vector
255	239	0x03FC	IRQ239
.	.	.	.
.	.	.	.
18	2	0x004C	IRQ2
17	1	0x0048	IRQ1
16	0	0x0044	IRQ0
15	-1	0x0040	Systick
14	-2	0x003C	PendSV
13		0x0038	Reserved
12			Reserved for Debug
11	-5	0x002C	SVCcall
10			Reserved
9			
8			
7			
6	-10	0x0018	Usage fault
5	-11	0x0014	Bus fault
4	-12	0x0010	Memory management fault
3	-13	0x000C	Hard fault
2	-14	0x0008	NMI
1		0x0004	Reset
		0x0000	Initial SP value

MSv39645V1

On system reset, the vector table is at address 0x00000000. Privileged software can write to the VTOR to relocate the vector table start address to a different memory location, in the range 0x00000000 to 0xFFFFF80.

The silicon vendor must configure the top range value, which is dependent on the number of interrupts implemented. The minimum alignment is 32 words, enough for up to 16 interrupts. For more interrupts, adjust the alignment by rounding up to the next power of two. For example, if the user requires 21 interrupts, the alignment must be on a 64-word boundary because the required table size is 37 words, and the next power of two is 64, see [Vector table offset register on page 197](#).

Arm recommends that the user locates the vector table in either the CODE, SRAM, External RAM, or External Device areas of the system memory map, see [Cortex®-M7 configurations on page 30](#). Using the Peripheral, Private peripheral bus, or Vendor-specific memory areas

can lead to unpredictable behavior in some systems. This is because the processor uses a different interfaces for load/store instructions and vector fetch in these memory areas. If the vector table is located in a region of memory that is cacheable, core must treat any load or store to the vector as self-modifying code and use cache maintenance instructions to synchronize the update to the data and instruction caches, see [Cache maintenance design hints and tips on page 244](#).

2.4.5 Exception priorities

As [Table 19 on page 40](#) shows, all the exceptions have an associated priority, with:

- A lower priority value indicating a higher priority.
- Configurable priorities for all the exceptions except Reset, HardFault, and NMI.

If the software does not configure any priorities, then all the exceptions with a configurable priority have a priority of 0. For information about configuring the exception priorities see

- [System handler priority registers on page 202](#).
- [Interrupt priority registers on page 188](#).

Note: Configurable priority values are in the range 0-255. This means that the Reset, HardFault, and NMI exceptions, with fixed negative priority values, always have higher priority than any other exception.

For example, assigning a higher priority value to IRQ[0] and a lower priority value to IRQ[1] means that IRQ[1] has higher priority than IRQ[0]. If both IRQ[1] and IRQ[0] are asserted, IRQ[1] is processed before IRQ[0].

If multiple pending exceptions have the same priority, the pending exception with the lowest exception number takes precedence. For example, if both IRQ[0] and IRQ[1] are pending and have the same priority, then IRQ[0] is processed before IRQ[1].

When the processor is executing an exception handler, the exception handler is preempted if a higher priority exception occurs. If an exception occurs with the same priority as the exception being handled, the handler is not preempted, irrespective of the exception number. However, the status of the new interrupt changes to pending.

2.4.6 Interrupt priority grouping

To increase priority control in systems with interrupts, the NVIC supports priority grouping. This divides each interrupt priority register entry into two fields:

- An upper field that defines the *group priority*.
- A lower field that defines a *subpriority* within the group.

Only the group priority determines preemption of interrupt exceptions. When the processor is executing an interrupt exception handler, another interrupt with the same group priority as the interrupt being handled does not preempt the handler,

If multiple pending interrupts have the same group priority, the subpriority field determines the order in which they are processed. If multiple pending interrupts have the same group priority and subpriority, the interrupt with the lowest IRQ number is processed first.

For information about splitting the interrupt priority fields into group priority and subpriority, see [Application interrupt and reset control register on page 197](#).

2.4.7 Exception entry and return

Descriptions of exception handling use the following terms:

- Preemption** When the processor is executing an exception handler, an exception can preempt the exception handler if its priority is higher than the priority of the exception being handled. See [Interrupt priority grouping on page 43](#) for more information about preemption by an interrupt.
- When one exception preempts another, the exceptions are called nested exceptions. See [Exception entry on page 44](#) more information.
- Return** This occurs when the exception handler is completed, and:
- There is no pending exception with sufficient priority to be serviced.
 - The completed exception handler was not handling a late-arriving exception.
- The processor pops the stack and restores the processor state to the state it had before the interrupt occurred. See [Exception return on page 46](#) for more information.
- Tail-chaining** This mechanism speeds up exception servicing. On completion of an exception handler, if there is a pending exception that meets the requirements for exception entry, the stack pop is skipped and control transfers to the new exception handler.
- Late-arriving** This mechanism speeds up preemption. If a higher priority exception occurs during state saving for a previous exception, the processor switches to handle the higher priority exception and initiates the vector fetch for that exception. State saving is not affected by late arrival because the state saved is the same for both exceptions. Therefore the state saving continues uninterrupted. The processor can accept a late arriving exception until the first instruction of the exception handler of the original exception enters the execute stage of the processor. On return from the exception handler of the late-arriving exception, the normal tail-chaining rules apply.

Exception entry

The exception entry occurs when there is a pending exception with sufficient priority and either:

- The processor is in Thread mode.
- The new exception is of higher priority than the exception being handled, in which case the new exception preempts the original exception.

When one exception preempts another, the exceptions are nested.

Sufficient priority means the exception has more priority than any limits set by the mask registers, see [Exception mask registers on page 25](#). An exception with less priority than this is pending but is not handled by the processor.

When the processor takes an exception, unless the exception is a tail-chained or a late-arriving exception, the processor pushes information onto the current stack. This operation is referred to as *stacking* and the structure of eight data words is referred to as the *stack frame*.

When using floating-point routines, the Cortex[®]-M7 processor automatically stacks the architected floating-point state on exception entry. *Figure 11 on page 45* shows the Cortex[®]-M7 stack frame layout when floating-point state is preserved on the stack as the result of an interrupt or an exception.

Note: Where stack space for floating-point state is not allocated, the stack frame is the same as that of Armv7-M implementations without an FPU. *Figure 11 on page 45* shows this stack frame also.

Figure 11. Exception stack frame

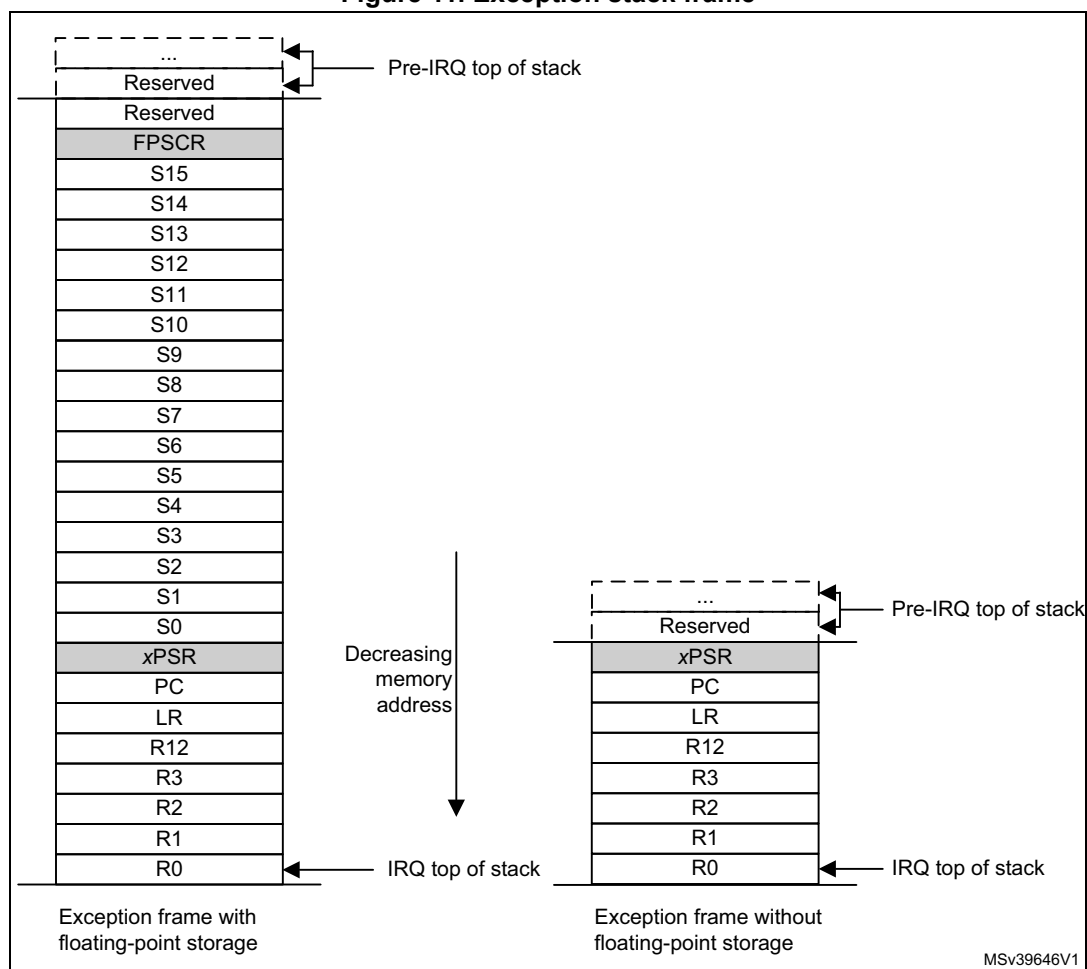

Immediately after stacking, the stack pointer indicates the lowest address in the stack frame. The alignment of the stack frame is controlled using the STKALIGN bit of the *Configuration Control register (CCR)*.

Note: In the Cortex[®]-M7 processor CCR.STKALIGN is read-only and has a value of 1. This means the stack address is always 8-byte aligned.

The stack frame includes the return address. This is the address of the next instruction in the interrupted program. This value is restored to the PC at exception return so that the interrupted program resumes.

In parallel to the stacking operation, the processor performs a vector fetch that reads the exception handler start address from the vector table. When stacking is complete, the

processor starts executing the exception handler. At the same time, the processor writes an EXC_RETURN value to the LR. This indicates which stack pointer corresponds to the stack frame and what operation mode the processor was in before the entry occurred.

If no higher priority exception occurs during exception entry, the processor starts executing the exception handler and automatically changes the status of the corresponding pending interrupt to active.

If another higher priority exception occurs during exception entry, the processor starts executing the exception handler for this exception and does not change the pending status of the earlier exception. This is the late arrival case.

Exception return

The exception return occurs when the processor is in Handler mode and executes one of the following instructions to load the EXC_RETURN value into the PC:

- An LDM or POP instruction that loads the PC.
- An LDR instruction with PC as the destination.
- A BX instruction using any register.

EXC_RETURN is the value loaded into the LR on exception entry. The exception mechanism relies on this value to detect when the processor has completed an exception handler. The lowest five bits of this value provide information on the return stack and processor mode. [Table 20](#) shows the EXC_RETURN values with a description of the exception return behavior.

All EXC_RETURN values have bits[31:5] set to one. When this value is loaded into the PC it indicates to the processor that the exception is complete, and the processor initiates the appropriate exception return sequence

Table 20. Exception return behavior

EXC_RETURN[31:0]	Description
0xFFFFFFFF1	Return to Handler mode, exception return uses non-floating-point state from the MSP and execution uses MSP after return.
0xFFFFFFFF9	Return to Thread mode, exception return uses non-floating-point state from MSP and execution uses MSP after return.
0xFFFFFFFFD	Return to Thread mode, exception return uses non-floating-point state from the PSP and execution uses PSP after return.
0xFFFFFEE1	Return to Handler mode, exception return uses floating-point-state from MSP and execution uses MSP after return.
0xFFFFFEE9	Return to Thread mode, exception return uses floating-point state from MSP and execution uses MSP after return.
0xFFFFFEEB	Return to Thread mode, exception return uses floating-point state from PSP and execution uses PSP after return.

2.5 Fault handling

Faults are a subset of the exceptions, see [Exception model on page 39](#). Faults are generated by:

- A bus error on:
 - An instruction fetch or vector table load.
 - A data access.
- An internally-detected error such as an undefined instruction.
- Attempting to execute an instruction from a memory region marked as *Execute Never* (XN).
- A privilege violation or an attempt to access an unmanaged region causing an MPU fault.

2.5.1 Fault types

[Table 21](#) shows the types of fault, the handler used for the fault, the corresponding fault status register, and the register bit that indicates that the fault has occurred. See [Configuration and control register on page 200](#) for more information about the fault status registers

Table 21. Faults

Fault	Handler	Bit name	Fault status register
Bus error on a vector read	HardFault	VECTTBL	HardFault status register on page 210
Fault escalated to a hard fault		FORCED	
MPU or default memory map mismatch:	MemManage	-	-
On instruction access		IACCVIOL ⁽¹⁾	MemManage fault status register on page 206
On data access		DACCVIOL	
During exception stacking		MSTKERR	
During exception unstacking		MUNSKERR	
During lazy floating-point state preservation	MLSPERR		
Bus error:	BusFault	-	-
During exception stacking		STKERR	BusFault status register on page 207
During exception unstacking		UNSTKERR	
During instruction prefetch		IBUSERR	
During lazy floating-point state preservation		LSPERR	
Precise data bus error		PRECISERR	
Imprecise data bus error		IMPRECISERR	

Table 21. Faults (continued)

Fault	Handler	Bit name	Fault status register
Attempt to access a coprocessor	UsageFault	NOCP	UsageFault status register on page 209
Undefined instruction		UNDEFINSTR	
Attempt to enter an invalid instruction set state ⁽²⁾		INVSTATE	
Invalid EXC_RETURN value		INVPC	
Illegal unaligned load or store		UNALIGNED	
Divide By 0		DIVBYZERO	

- Occurs on an access to an XN region even if the processor does not include an MPU or the MPU is disabled.
- Attempting to use an instruction set other than the Thumb instruction set or returns to a non load/store-multiple instruction with ICI continuation.

2.5.2 Fault escalation and hard faults

All the fault exceptions except for HardFault have configurable exception priority, see [System handler priority registers on page 202](#). the software can disable the execution of the handlers for these faults, see [System handler control and state register on page 204](#).

Usually, the exception priority, together with the values of the exception mask registers, determines whether the processor enters the fault handler, and whether a fault handler can preempt another fault handler. as described in [Exception model on page 39](#).

In some situations, a fault with configurable priority is treated as a HardFault. This is called *priority escalation*, and the fault is described as *escalated to HardFault*. Escalation to HardFault occurs when:

- A fault handler causes the same kind of fault as the one it is servicing. This escalation to HardFault occurs because a fault handler cannot preempt itself because it must have the same priority as the current priority level.
- A fault handler causes a fault with the same or lower priority as the fault it is servicing. This is because the handler for the new fault cannot preempt the currently executing fault handler.
- An exception handler causes a fault for which the priority is the same as or lower than the currently executing exception.
- A fault occurs and the handler for that fault is not enabled.

If a BusFault occurs during a stack push when entering a BusFault handler, the BusFault does not escalate to a HardFault. This means that if a corrupted stack causes a fault, the fault handler executes even though the stack push for the handler failed. The fault handler operates but the stack contents are corrupted.

Note: Only Reset and NMI can preempt the fixed priority HardFault. A HardFault can preempt any exception other than Reset, NMI, or another HardFault.

2.5.3 Synchronous and Asynchronous bus faults

In the Cortex[®]-M7 processor all bus faults triggered by:

- Processor load operations are synchronous.
- Processor store operations are asynchronous, including stores to Device and Strongly-ordered regions.
- Debugger load or store accesses are synchronous, and are visible to the debugger interface only.

When an asynchronous bus fault is triggered, the BusFault exception is pended. If the BusFault handler is not enabled, the HardFault exception is pended instead. The HardFault caused by the asynchronous BusFault never escalates into lockup.

If an IRQ is triggered after the write, the write buffer might not drain before the ISR is executed. Therefore an asynchronous BusFault can occur across context boundaries.

A synchronous BusFault can escalate into lockup if it occurs inside a NMI or HardFault handler.

Cache maintenance operations can also trigger a bus fault. See [Faults handling considerations on page 244](#) for more information.

2.5.4 Fault status registers and fault address registers

The fault status registers indicate the cause of a fault. For synchronous BusFaults and MemManage faults, the fault address register indicates the address accessed by the operation that caused the fault, as shown in [Table 22](#).

Table 22. Fault status and fault address registers

Handler	Status register name	Address register name	Register description
HardFault	HFSR	-	HardFault status register on page 210
MemManage	MMFSR	MMFAR	MemManage fault status register on page 206 MemManage fault address register on page 211
BusFault	BFSR	BFAR	BusFault status register on page 207 BusFault address register on page 212
UsageFault	UFSR	-	UsageFault status register on page 209

2.5.5 Lockup

The processor enters a lockup state if a fault occurs when executing the NMI or HardFault handlers. When the processor is in lockup state it does not execute any instructions. The processor remains in lockup state until either:

- It is reset.
- An NMI occurs.
- It is halted by a debugger.

Note: If a lockup state occurs from the NMI handler a subsequent NMI does not cause the processor to leave lockup state.

2.6 Power management

The Cortex[®]-M7 processor sleep modes reduce power consumption:

- Sleep mode stops the processor clock.
- Deep sleep mode stops the system clock and switches off the PLL and the Flash memory.

The SLEEPDEEP bit of the SCR selects which sleep mode is used, see [System control register on page 199](#).

For more information about the behavior of the sleep modes see specific STM32 product referene manual.

This section describes the mechanisms for entering sleep mode, and the conditions for waking up from sleep mode.

2.6.1 Entering sleep mode

This section describes the mechanisms software can use to put the processor into sleep mode.

The system can generate spurious wakeup events, for example a debug operation wakes up the processor. Therefore software must be able to put the processor back into sleep mode after such an event. A program might have an idle loop to put the processor back to sleep mode.

Wait for interrupt

The *wait for interrupt* instruction, WFI, causes immediate entry to sleep mode unless the wakeup condition is true, see [Wakeup from WFI or sleep-on-exit on page 51](#). When the processor executes a WFI instruction it stops executing instructions and enters sleep mode. See [WFI on page 182](#) for more information.

Wait for event

The *wait for event* instruction, WFE, causes entry to sleep mode depending on the value of a one-bit event register. When the processor executes a WFE instruction, it checks the value of the event register:

- 0: The processor stops executing instructions and enters sleep mode.
- 1: The processor clears the register to 0 and continues executing instructions without entering sleep mode.

See [WFE on page 181](#) for more information.

If the event register is 1, this indicates that the processor must not enter sleep mode on execution of a WFE instruction. Typically, this is because an external event signal is asserted, or a processor in the system has executed an SEV instruction, see [SEV on page 180](#). Software cannot access this register directly.

Sleep-on-exit

If the SLEEPONEXIT bit of the SCR is set to 1, when the processor completes the execution of all exception handlers it returns to Thread mode and immediately enters sleep mode. Use this mechanism in applications that only require the processor to run when an exception occurs.

2.6.2 Wakeup from sleep mode

The conditions for the processor to wakeup depend on the mechanism that cause it to enter sleep mode.

Wakeup from WFI or sleep-on-exit

Normally, the processor wakes up only when it detects an exception with sufficient priority to cause exception entry. Some embedded systems might have to execute system restore tasks after the processor wakes up, and before it executes an interrupt handler. To achieve this set the PRIMASK bit to 1 and the FAULTMASK bit to 0. If an interrupt arrives that is enabled and has a higher priority than the current exception priority, the processor wakes up but does not execute the interrupt handler until the processor sets PRIMASK to zero. For more information about PRIMASK and FAULTMASK see [Exception mask registers on page 25](#).

Wakeup from WFE

The processor wakes up if:

- It detects an exception with sufficient priority to cause exception entry.
- It detects an external event signal, see [The external event input](#).
- In a multiprocessor system, another processor in the system executes an SEV instruction.

In addition, if the SEVONPEND bit in the SCR is set to 1, any new pending interrupt triggers an event and wakes up the processor, even if the interrupt is disabled or has insufficient priority to cause exception entry. For more information about the SCR see [System control register on page 199](#).

2.6.3 The external event input

The processor provides an external event input signal. Peripherals can drive this signal, either to wake the processor from WFE, or to set the internal WFE event register to one to indicate that the processor must not enter sleep mode on a later WFE instruction. See [Wait for event on page 50](#) for more information.

2.6.4 Power management programming hints

ISO/IEC C cannot directly generate the WFI and WFE instructions. The CMSIS provides the following functions for these instructions:

```
void __WFE(void) // Wait for Event
void __WFI(void) // Wait for Interrupt
```

3 The Cortex-M7 instruction set

3.1 Instruction set summary

The processor implements Armv7-M instruction set and features provided by the Armv7E-M architecture profile. [Table 23](#) lists the supported instructions.

In [Table 23](#):

- Angle brackets, <>, enclose alternative forms of the operand.
- Braces, {}, enclose optional operands.
- The Operands column is not exhaustive.
- Op2 is a flexible second operand that can be either a register or a constant.
- Most instructions can use an optional condition code suffix.

For more information on the instructions and operands, see the instruction descriptions.

Table 23. Cortex[®]-M7 instructions

Mnemonic	Operands	Brief description	Flags	Page
ADC, ADCS	{Rd,} Rn, Op2	Add with Carry	N,Z,C,V	3.5.1 on page 87
ADD, ADDS	{Rd,} Rn, Op2	Add	N,Z,C,V	3.5.1 on page 87
ADD, ADDW	{Rd,} Rn, #imm12	Add	-	3.5.1 on page 87
ADR	Rd, label	Load PC-relative Address	-	3.4.1 on page 73
AND, ANDS	{Rd,} Rn, Op2	Logical AND	N,Z,C	3.5.2 on page 89
ASR, ASRS	Rd, Rm, <Rs #n>	Arithmetic Shift Right	N,Z,C	3.5.3 on page 90
B	label	Branch	-	3.10.1 on page 145
BFC	Rd, #lsb, #width	Bit Field Clear	-	3.9.1 on page 142
BFI	Rd, Rn, #lsb, #width	Bit Field Insert	-	3.9.1 on page 142
BIC, BICS	{Rd,} Rn, Op2	Bit Clear	N,Z,C	3.5.2 on page 89
BKPT	#imm	Breakpoint	-	3.12.1 on page 175
BL	label	Branch with Link	-	3.10.1 on page 145
BLX	Rm	Branch indirect with Link	-	3.10.1 on page 145
BX	Rm	Branch indirect	-	3.10.1 on page 145
CBNZ	Rn, label	Compare and Branch if Non Zero	-	3.10.2 on page 147
CBZ	Rn, label	Compare and Branch if Zero	-	3.10.2 on page 147
CLREX	-	Clear Exclusive	-	3.4.10 on page 84
CLZ	Rd, Rm	Count Leading Zeros	-	3.5.4 on page 91
CMN	Rn, Op2	Compare Negative	N,Z,C,V	3.5.5 on page 92
CMP	Rn, Op2	Compare	N,Z,C,V	3.5.5 on page 92

Table 23. Cortex[®]-M7 instructions (continued)

Mnemonic	Operands	Brief description	Flags	Page
CPSID	i	Change Processor State, Disable Interrupts	-	3.12.2 on page 176
CPSIE	i	Change Processor State, Enable Interrupts	-	3.12.2 on page 176
DMB	-	Data Memory Barrier	-	3.12.3 on page 177
DSB	-	Data Synchronization Barrier	-	3.12.4 on page 177
EOR, EORS	{Rd,} Rn, Op2	Exclusive OR	N,Z,C	3.5.2 on page 89
ISB	-	Instruction Synchronization Barrier	-	3.12.5 on page 178
IT	-	If-Then condition block	-	3.10.3 on page 148
LDM	Rn{!}, reglist	Load Multiple registers, increment after	-	3.4.6 on page 79
LDMDB, LDMEA	Rn{!}, reglist	Load Multiple registers, decrement before	-	3.4.6 on page 79
LDMFD, LDMIA	Rn{!}, reglist	Load Multiple registers, increment after	-	3.4.6 on page 79
LDR	Rt, [Rn, #offset]	Load register with word	-	3.4.2 on page 73
LDRB, LDRBT	Rt, [Rn, #offset]	Load register with byte	-	3.4.2 on page 73
LDRD	Rt, Rt2, [Rn, #offset]	Load register with two bytes	-	3.4.4 on page 77
LDREX	Rt, [Rn, #offset]	Load register Exclusive	-	3.4.9 on page 83
LDREXB	Rt, [Rn]	Load register Exclusive with Byte	-	3.4.9 on page 83
LDREXH	Rt, [Rn]	Load register Exclusive with Halfword	-	3.4.9 on page 83
LDRH, LDRHT	Rt, [Rn, #offset]	Load register with Halfword	-	3.4.2 on page 73
LDRSB, LDRSBT	Rt, [Rn, #offset]	Load register with Signed Byte	-	3.4.2 on page 73
LDRSH, LDRSHT	Rt, [Rn, #offset]	Load register with Signed Halfword	-	3.4.2 on page 73
LDRT	Rt, [Rn, #offset]	Load register with word	-	3.4.2 on page 73
LSL, LSLS	Rd, Rm, <Rs #n>	Logical Shift Left	N,Z,C	3.5.3 on page 90
LSR, LSRS	Rd, Rm, <Rs #n>	Logical Shift Right	N,Z,C	3.5.3 on page 90
MLA	Rd, Rn, Rm, Ra	Multiply with Accumulate, 32-bit result	-	3.6.1 on page 112
MLS	Rd, Rn, Rm, Ra	Multiply and Subtract, 32-bit result	-	3.6.1 on page 112
MOV, MOVS	Rd, Op2	Move	N,Z,C	3.5.6 on page 93
MOVT	Rd, #imm16	Move Top	-	3.5.7 on page 94

Table 23. Cortex[®]-M7 instructions (continued)

Mnemonic	Operands	Brief description	Flags	Page
MOVW, MOV	Rd, #imm16	Move 16-bit constant	N,Z,C	3.5.6 on page 93
MRS	Rd, spec_reg	Move from Special register to general register	-	3.12.6 on page 178
MSR	spec_reg, Rm	Move from general register to Special register	N,Z,C,V	3.12.7 on page 179
MUL, MULS	{Rd,} Rn, Rm	Multiply, 32-bit result	N,Z	3.6.1 on page 112
MVN, MVNS	Rd, Op2	Move NOT	N,Z,C	3.5.6 on page 93
NOP	-	No Operation	-	3.12.8 on page 180
ORN, ORNS	{Rd,} Rn, Op2	Logical OR NOT	N,Z,C	3.5.2 on page 89
ORR, ORRS	{Rd,} Rn, Op2	Logical OR	N,Z,C	3.5.2 on page 89
PKHTB, PKHBT	{Rd,} Rn, Rm, Op2	Pack Halfword	-	3.8.1 on page 138
PLD	[Rn, #offset]	Preload Data	-	3.4.7 on page 81
POP	reglist	Pop registers from stack	-	3.4.8 on page 82
PUSH	reglist	Push registers onto stack	-	3.4.8 on page 82
QADD	{Rd,} Rn, Rm	Saturating double and Add	Q	3.7.3 on page 131
QADD16	{Rd,} Rn, Rm	Saturating Add 16	-	3.7.3 on page 131
QADD8	{Rd,} Rn, Rm	Saturating Add 8	-	3.7.3 on page 131
QASX	{Rd,} Rn, Rm	Saturating Add and Subtract with Exchange	-	3.7.4 on page 132
QDADD	{Rd,} Rn, Rm	Saturating Add	Q	3.7.5 on page 133
QDSUB	{Rd,} Rn, Rm	Saturating double and Subtract	Q	3.7.3 on page 131
QSAX	{Rd,} Rn, Rm	Saturating Subtract and Add with Exchange	-	3.7.4 on page 132
QSUB	{Rd,} Rn, Rm	Saturating Subtract	Q	3.7.3 on page 131
QSUB16	{Rd,} Rn, Rm	Saturating Subtract 16	-	3.7.3 on page 131
QSUB8	{Rd,} Rn, Rm	Saturating Subtract 8	-	3.7.3 on page 131
RBIT	Rd, Rn	Reverse Bits	-	3.5.8 on page 95
REV	Rd, Rn	Reverse byte order in a word	-	3.5.8 on page 95
REV16	Rd, Rn	Reverse byte order in each halfword	-	3.5.8 on page 95
REVSH	Rd, Rn	Reverse byte order in bottom halfword and sign extend	-	3.5.8 on page 95
ROR, RORS	Rd, Rm, <Rs #n>	Rotate Right	N,Z,C	3.5.3 on page 90
RRX, RRXS	Rd, Rm	Rotate Right with Extend	N,Z,C	3.5.3 on page 90
RSB, RSBS	{Rd,} Rn, Op2	Reverse Subtract	N,Z,C,V	3.5.1 on page 87

Table 23. Cortex[®]-M7 instructions (continued)

Mnemonic	Operands	Brief description	Flags	Page
SADD16	{Rd,} Rn, Rm	Signed Add 16	GE	3.5.9 on page 96
SADD8	{Rd,} Rn, Rm	Signed Add 8	GE	3.5.9 on page 96
SASX	{Rd,} Rn, Rm	Signed Add and Subtract with Exchange	GE	3.5.14 on page 101
SBC, SBCS	{Rd,} Rn, Op2	Subtract with Carry	N,Z,C,V	3.5.1 on page 87
SBFX	Rd, Rn, #lsb, #width	Signed Bit Field Extract	-	3.9.2 on page 143
SDIV	{Rd,} Rn, Rm	Signed Divide	-	3.6.12 on page 127
SEL	{Rd,} Rn, Rm	Select bytes	-	3.5.21 on page 108
SEV	-	Send Event	-	3.12.9 on page 180
SHADD16	{Rd,} Rn, Rm	Signed Halving Add 16	-	3.5.10 on page 97
SHADD8	{Rd,} Rn, Rm	Signed Halving Add 8	-	3.5.10 on page 97
SHASX	{Rd,} Rn, Rm	Signed Halving Add and Subtract with Exchange	-	3.5.11 on page 98
SHSAX	{Rd,} Rn, Rm	Signed Halving Subtract and Add with Exchange	-	3.5.11 on page 98
SHSUB16	{Rd,} Rn, Rm	Signed Halving Subtract 16	-	3.5.12 on page 99
SHSUB8	{Rd,} Rn, Rm	Signed Halving Subtract 8	-	3.5.12 on page 99
SMLABB, SMLABT, SMLATB, SMLATT	Rd, Rn, Rm, Ra	Signed Multiply Accumulate Long (halfwords)	Q	3.6.3 on page 115
SMLAD, SMLADX	Rd, Rn, Rm, Ra	Signed Multiply Accumulate Dual	Q	3.6.4 on page 116
SMLAL	RdLo, RdHi, Rn, Rm	Signed Multiply with Accumulate (32 x 32 + 64), 64-bit result	-	3.6.5 on page 117
SMLALBB, SMLALBT, SMLALTB, SMLALTT	RdLo, RdHi, Rn, Rm	Signed Multiply Accumulate Long, halfwords	-	3.6.5 on page 117
SMLALD, SMLALDX	RdLo, RdHi, Rn, Rm	Signed Multiply Accumulate Long Dual	-	3.6.5 on page 117
SMLAWB, SMLAWT	Rd, Rn, Rm, Ra	Signed Multiply Accumulate, word by halfword	Q	3.6.3 on page 115
SMLSD	Rd, Rn, Rm, Ra	Signed Multiply Subtract Dual	Q	3.6.6 on page 119
SMLS LD	RdLo, RdHi, Rn, Rm	Signed Multiply Subtract Long Dual	-	3.6.6 on page 119
SMMLA	Rd, Rn, Rm, Ra	Signed Most significant word Multiply Accumulate	-	3.6.7 on page 121

Table 23. Cortex[®]-M7 instructions (continued)

Mnemonic	Operands	Brief description	Flags	Page
SMMLS, SMMLR	Rd, Rn, Rm, Ra	Signed Most significant word Multiply Subtract	-	3.6.7 on page 121
SMMUL, SMMULR	{Rd,} Rn, Rm	Signed Most significant word Multiply	-	3.6.8 on page 122
SMUAD	{Rd,} Rn, Rm	Signed dual Multiply Add	Q	3.6.9 on page 123
SMULBB, SMULBT, SMULTB, SMULTT	{Rd,} Rn, Rm	Signed Multiply (halfwords)	-	3.6.10 on page 124
SMULL	RdLo, RdHi, Rn, Rm	Signed Multiply (32 x 32), 64-bit result	-	3.6.11 on page 126
SMULWB, SMULWT	{Rd,} Rn, Rm	Signed Multiply word by halfword	-	3.6.10 on page 124
SMUSD, SMUSDX	{Rd,} Rn, Rm	Signed dual Multiply Subtract	-	3.6.9 on page 123
SSAT	Rd, #n, Rm {,shift #s}	Signed Saturate	Q	3.7.1 on page 129
SSAT16	Rd, #n, Rm	Signed Saturate 16	Q	3.7.2 on page 130
SSAX	{Rd,} Rn, Rm	Signed Subtract and Add with Exchange	GE	3.5.14 on page 101
SSUB16	{Rd,} Rn, Rm	Signed Subtract 16	-	3.5.13 on page 100
SSUB8	{Rd,} Rn, Rm	Signed Subtract 8	-	3.5.13 on page 100
STM	Rn{!}, reglist	Store Multiple registers, increment after	-	3.4.6 on page 79
STMDB, STMEA	Rn{!}, reglist	Store Multiple registers, decrement before	-	3.4.6 on page 79
STMFD, STMIA	Rn{!}, reglist	Store Multiple registers, increment after	-	3.4.6 on page 79
STR	Rt, [Rn, #offset]	Store register word	-	3.4.2 on page 73
STRB, STRBT	Rt, [Rn, #offset]	Store register byte	-	3.4.2 on page 73
STRD	Rt, Rt2, [Rn, #offset]	Store register two words	-	3.4.2 on page 73
STREX	Rd, Rt, [Rn, #offset]	Store register Exclusive	-	3.4.9 on page 83
STREXB	Rd, Rt, [Rn]	Store register Exclusive Byte	-	3.4.9 on page 83
STREXH	Rd, Rt, [Rn]	Store register Exclusive Halfword	-	3.4.9 on page 83
STRH, STRHT	Rt, [Rn, #offset]	Store register Halfword	-	3.4.2 on page 73
STRT	Rt, [Rn, #offset]	Store register word	-	3.4.2 on page 73
SUB, SUBS	{Rd,} Rn, Op2	Subtract	N,Z,C,V	3.5.1 on page 87

Table 23. Cortex[®]-M7 instructions (continued)

Mnemonic	Operands	Brief description	Flags	Page
SUB, SUBW	{Rd,} Rn, #imm12	Subtract	-	3.5.1 on page 87
SVC	#imm	Supervisor Call	-	3.5.1 on page 87
SXTAB	{Rd,} Rn, Rm, {,ROR #}	Extend 8 bits to 32 and add	-	3.8.3 on page 140
SXTAB16	{Rd,} Rn, Rm, {,ROR #}	Dual extend 8 bits to 16 and add	-	3.8.3 on page 140
SXTAH	{Rd,} Rn, Rm, {,ROR #}	Extend 16 bits to 32 and add	-	3.8.3 on page 140
SXTB16	{Rd,} Rm {,ROR #n}	Signed Extend Byte 16	-	3.9.3 on page 144
SXTB	{Rd,} Rm {,ROR #n}	Sign extend a byte	-	3.9.3 on page 144
SXTH	{Rd,} Rm {,ROR #n}	Sign extend a halfword	-	3.9.3 on page 144
TBB	[Rn, Rm]	Table Branch Byte	-	3.10.4 on page 150
TBH	[Rn, Rm, LSL #1]	Table Branch Halfword	-	3.10.4 on page 150
TEQ	Rn, Op2	Test Equivalence	N,Z,C	3.5.15 on page 102
TST	Rn, Op2	Test	N,Z,C	3.5.15 on page 102
UADD16	{Rd,} Rn, Rm	Unsigned Add 16	GE	3.5.16 on page 103
UADD8	{Rd,} Rn, Rm	Unsigned Add 8	GE	3.5.16 on page 103
USAX	{Rd,} Rn, Rm	Unsigned Subtract and Add with Exchange	GE	3.5.17 on page 104
UHADD16	{Rd,} Rn, Rm	Unsigned Halving Add 16	-	3.5.18 on page 105
UHADD8	{Rd,} Rn, Rm	Unsigned Halving Add 8	-	3.5.18 on page 105
UHASX	{Rd,} Rn, Rm	Unsigned Halving Add and Subtract with Exchange	-	3.5.19 on page 106
UHSAX	{Rd,} Rn, Rm	Unsigned Halving Subtract and Add with Exchange	-	3.5.19 on page 106
UHSUB16	{Rd,} Rn, Rm	Unsigned Halving Subtract 16	-	3.5.20 on page 107
UHSUB8	{Rd,} Rn, Rm	Unsigned Halving Subtract 8	-	3.5.20 on page 107
UBFX	Rd, Rn, #lsb, #width	Unsigned Bit Field Extract	-	3.9.2 on page 143
UDIV	{Rd,} Rn, Rm	Unsigned Divide	-	3.6.12 on page 127
UMAAL	RdLo, RdHi, Rn, Rm	Unsigned Multiply Accumulate Accumulate Long (32 x 32 + 32 +32), 64-bit result	-	3.6.2 on page 113
UMLAL	RdLo, RdHi, Rn, Rm	Unsigned Multiply with Accumulate (32 x 32 + 64), 64-bit result	-	3.6.2 on page 113
UMULL	RdLo, RdHi, Rn, Rm	Unsigned Multiply (32 x 32), 64-bit result	-	3.6.2 on page 113

Table 23. Cortex[®]-M7 instructions (continued)

Mnemonic	Operands	Brief description	Flags	Page
UQADD16	{Rd,} Rn, Rm	Unsigned Saturating Add 16	-	3.7.7 on page 136
UQADD8	{Rd,} Rn, Rm	Unsigned Saturating Add 8	-	3.7.7 on page 136
UQASX	{Rd,} Rn, Rm	Unsigned Saturating Add and Subtract with Exchange	-	3.7.6 on page 134
UQSAX	{Rd,} Rn, Rm	Unsigned Saturating Subtract and Add with Exchange	-	3.7.6 on page 134
UQSUB16	{Rd,} Rn, Rm	Unsigned Saturating Subtract 16	-	3.7.7 on page 136
UQSUB8	{Rd,} Rn, Rm	Unsigned Saturating Subtract 8	-	3.7.7 on page 136
USAD8	{Rd,} Rn, Rm	Unsigned Sum of Absolute Differences	-	3.5.22 on page 108
USADA8	{Rd,} Rn, Rm, Ra	Unsigned Sum of Absolute Differences and Accumulate	-	3.5.23 on page 109
USAT	Rd, #n, Rm {, shift #s}	Unsigned Saturate	Q	3.7.1 on page 129
USAT16	Rd, #n, Rm	Unsigned Saturate 16	Q	3.7.2 on page 130
UASX	{Rd,} Rn, Rm	Unsigned Add and Subtract with Exchange	GE	3.5.17 on page 104
USUB16	{Rd,} Rn, Rm	Unsigned Subtract 16	GE	3.5.24 on page 110
USUB8	{Rd,} Rn, Rm	Unsigned Subtract 8	GE	3.5.24 on page 110
UXTAB	{Rd,} Rn, Rm, {, ROR #}	Rotate, extend 8 bits to 32 and Add	-	3.8.3 on page 140
UXTAB16	{Rd,} Rn, Rm, {, ROR #}	Rotate, dual extend 8 bits to 16 and Add	-	3.8.3 on page 140
UXTAH	{Rd,} Rn, Rm, {, ROR #}	Rotate, unsigned extend and Add Halfword	-	3.8.3 on page 140
UXTB	{Rd,} Rm {, ROR #n}	Zero extend a Byte	-	3.9.3 on page 144
UXTB16	{Rd,} Rm {, ROR #n}	Unsigned Extend Byte 16	-	3.9.3 on page 144
UXTH	{Rd,} Rm {, ROR #n}	Zero extend a Halfword	-	3.9.3 on page 144
VABS.F<32 64>	<Sd Dd>, <Sm Dm>	Floating-point Absolute	-	3.11.1 on page 153
VADD.F<32 64>	{<Sd Dd>, } <Sn Dn>, <Sm Dm>	Floating-point Add	-	3.11.2 on page 153
VCMP.F<32 64>	<Sd Dd>, <<Sm Dm> #0.0>	Compare two floating-point registers, or one floating-point register and zero	FPSCR	3.11.3 on page 154

Table 23. Cortex[®]-M7 instructions (continued)

Mnemonic	Operands	Brief description	Flags	Page
VCMPE.F<32 64>	<Sd Dd>, <<Sm Dm> #0.0>	Compare two floating-point registers, or one floating-point register and zero with Invalid Operation check	FPSCR	3.11.3 on page 154
VCVT	F<32 64>. <S U>, <16 32>	Convert from floating-point to fixed point	-	3.11.5 on page 156
VCVT	<S U>, <16 32>. F<32 64>	Convert from fixed point to floating-point	-	3.11.5 on page 156
VCVT.S32.F<32 64>	<Sd Dd>, <Sm Dm>	Convert from floating-point to integer	-	3.11.4 on page 155
VCVT<B T>.F<32 64>.F16	<Sd Dd>, Sm	Convert half-precision value to single-precision or double-precision	-	3.11.6 on page 157
VCVTA.F<32 64>	<Sd Dd>, <Sm Dm>	Convert from floating-point to integer with directed rounding to nearest ties away	-	3.11.33 on page 173
VCVTM.F<32 64>	<Sd Dd>, <Sm Dm>	Convert from floating-point to integer with directed rounding towards minus infinity	-	3.11.33 on page 173
VCVTN.F<32 64>	<Sd Dd>, <Sm Dm>	Convert from floating-point to integer with directed rounding to nearest even	-	3.11.33 on page 173
VCVTP.F<32 64>	<Sd Dd>, <Sm Dm>	Convert from floating-point to integer with directed rounding towards plus infinity	-	3.11.33 on page 173
VCVTR.S32.F<32 64>	<Sd Dd>, <Sm Dm>	Convert between floating-point and integer with rounding.	FPSCR	3.11.4 on page 155
VCVT<B T>.F16.F<32 64>	Sd, <Sm Dm>	Convert single-precision or double precision register to half-precision	-	3.11.5 on page 156
VDIV.F<32 64>	{<Sd Dd>, } <Sn Dn>, <Sm Dm>	Floating-point Divide	-	3.11.7 on page 157
VFMA.F<32 64>	{<Sd Dd>, } <Sn Dn>, <Sm Dm>	Floating-point Fused Multiply Accumulate	-	3.11.8 on page 158
VFMS.F<32 64>	{<Sd Dd>, } <Sn Dn>, <Sm Dm>	Floating-point Fused Multiply Subtract	-	3.11.8 on page 158
VFNMA.F<32 64>	{<Sd Dd>, } <Sn Dn>, <Sm Dm>	Floating-point Fused Negate Multiply Accumulate	-	3.11.9 on page 159
VFNMS.F<32 64>	{<Sd Dd>, } <Sn Dn>, <Sm Dm>	Floating-point Fused Negate Multiply Subtract	-	3.11.9 on page 159

Table 23. Cortex[®]-M7 instructions (continued)

Mnemonic	Operands	Brief description	Flags	Page
VLDM.F<32 64>	Rn{!}, list	Load Multiple extension registers	-	3.11.10 on page 159
VLDR.F<32 64>	<Sd Dd>, [<Rn>{, #+/-<imm>}]	Load an extension register from memory	-	3.11.11 on page 160
VLDR.F<32 64>	<Sd Dd>, <label>	Load an extension register from memory	-	3.11.11 on page 160
VLDR.F<32 64>	<Sd Dd>, [PC, #-0]	Load an extension register from memory	-	3.11.11 on page 160
VMLA.F<32 64>	{<Sd Dd>, } <Sn Dn>, <Sm Dm>	Floating-point Multiply Accumulate	-	3.11.12 on page 161
VMLS.F<32 64>	{<Sd Dd>, } <Sn Dn>, <Sm Dm>	Floating-point Multiply Subtract	-	3.11.12 on page 161
VMAXNM.F<32 64>	<Sd Dd>, <Sn Dn>, <Sm Dm>	Maximum of two floating-point numbers with IEEE754-2008 NaN handling	-	3.11.32 on page 172
VMINNM.F<32 64>	<Sd Dd>, <Sn Dn>, <Sm Dm>	Minimum of two floating-point numbers with IEEE754-2008 NaN handling	-	3.11.32 on page 172
VMOV	<Sd Dd>, <Sm Dm>	Floating-point Move register	-	3.11.19 on page 165
VMOV	<Sn Dn>, Rt	Copy Arm core register to single-precision	-	3.11.19 on page 165
VMOV	<Sm Dm>, <Sm Dm>1, Rt, Rt2	Copy two Arm core registers to two single-precision	-	3.11.19 on page 165
VMOV	Dd[x], Rt	Copy Arm core register to scalar	-	3.11.19 on page 165
VMOV	Rt, Dn[x]	Copy scalar to Arm core register	-	3.11.19 on page 165
VMOV.F<32 64>	<Sd Dd>, #imm	Floating-point Move immediate	-	3.11.19 on page 165
VMUL.F<32 64>	{<Sd Dd>, } <Sn Dn>, <Sm Dm>	Floating-point Multiply	-	3.11.22 on page 166
VNEG.F<32 64>	<Sd Dd>, <Sm Dm>	Floating-point Negate	-	3.11.23 on page 167
VNMLA.F<32 64>	<Sd Dd>, <Sn Dn>, <Sm Dm>	Floating-point Multiply and Add	-	3.11.24 on page 167
VNMLS.F<32 64>	<Sd Dd>, <Sn Dn>, <Sm Dm>	Floating-point Multiply and Subtract	-	3.11.24 on page 167
VNMUL.F<32 64>	{<Sd Dd>, } <Sn Dn>, <Sm Dm>	Floating-point Multiply	-	3.11.24 on page 167

Table 23. Cortex[®]-M7 instructions (continued)

Mnemonic	Operands	Brief description	Flags	Page
VRINTA.F<32 64>	<Sd Dd>, <Sm Dm>	Float to integer in floating-point format conversion with directed rounding	-	3.11.35 on page 174
VRINTM.F<32 64>	<Sd Dd>, <Sm Dm>	Float to integer in floating-point format conversion with directed rounding	-	3.11.35 on page 174
VRINTN.F<32 64>	<Sd Dd>, <Sm Dm>	Float to integer in floating-point format conversion with directed rounding	-	3.11.35 on page 174
VRINTP.F<32 64>	<Sd Dd>, <Sm Dm>	Float to integer in floating-point format conversion with directed rounding	-	3.11.35 on page 174
VRINTR.F<32 64>	<Sd Dd>, <Sm Dm>	Float to integer in floating-point format conversion	-	3.11.34 on page 173
VRINTX.F<32 64>	<Sd Dd>, <Sm Dm>	Float to integer in floating-point format conversion	-	3.11.34 on page 173
VRINTZ.F<32 64>	<Sd Dd>, <Sm Dm>	Float to integer in floating-point format conversion	-	3.11.35 on page 174
VSEL.F<32 64>	<Sd Dd>, <Sn Dn>, <Sm Dm>	Select register, alternative to a pair of conditional VMOV	-	3.11.31 on page 172
VSQRT.F<32 64>	<Sd Dd>, <Sm Dm>	Calculates floating-point Square Root	-	3.11.27 on page 169
VSTR.F<32 64>	<Sd Dd>, [Rn]	Stores an extension register to memory	-	3.11.29 on page 170
VSUB.F<32 64>	{<Sd Dd>, } <Sn Dn>, <Sm Dm>	Floating-point Subtract	-	3.11.30 on page 171
WFE	-	Wait For Event	-	3.12.11 on page 181
WFI	-	Wait For Interrupt	-	3.12.12 on page 182

3.1.1 Binary compatibility with other Cortex processors

The processor implements the Armv7-M instruction set and features provided by the Armv7-M architecture profile, and is binary compatible with the instruction sets and features implemented in other Cortex[®]-M profile processors. The user cannot move software from the Cortex[®]-M7 processor to:

- The Cortex[®]-M3 processor if it contains floating-point operations or DSP extensions.
- The Cortex[®]-M4 processor if it contains double-precision floating-point operations.
- The Cortex[®]-M0 or Cortex[®]-M0+ processors because these are implementations of the Armv6-M Architecture.

The code designed for other Cortex[®]-M processors is compatible with Cortex[®]-M7 as long as it does not rely on bit-banding.

To ensure a smooth transition, Arm recommends that the code designed to operate on other Cortex[®]-M profile processor architectures obey the following rules and that the *Configuration and Control Register (CCR)* be appropriately configured:

- Use word transfers only to access registers in the NVIC and *System Control Space (SCS)*.
- Treat all unused SCS registers and register fields on the processor as Do-Not-Modify.
- Configure the following fields in the CCR register:
 - STKALIGN bit to 1.
 - UNALIGN_TRP bit to 1.
 - Leave all other bits in the CCR register at their original value.

3.2 CMSIS functions

ISO/IEC C code cannot directly access some Cortex[®]-M7 processor instructions. This section describes intrinsic functions that can generate these instructions, provided by the CMSIS and that might be provided by a C compiler. If a C compiler does not support an appropriate intrinsic function, the user might have to use inline assembler to access some instructions.

The CMSIS provides the following intrinsic functions to generate instructions that ISO/IEC C code cannot directly access:

Table 24. CMSIS functions to generate some Cortex[®]-M7 processor instructions

Instruction	CMSIS function
CPSIE I	void __enable_irq(void)
CPSID I	void __disable_irq(void)
CPSIE F	void __enable_fault_irq(void)
CPSID F	void __disable_fault_irq(void)
ISB	void __ISB(void)
DSB	void __DSB(void)
DMB	void __DMB(void)
REV	uint32_t __REV(uint32_t int value)
REV16	uint32_t __REV16(uint32_t int value)
REVSH	uint32_t __REVSH(uint32_t int value)
RBIT	uint32_t __RBIT(uint32_t int value)
SEV	void __SEV(void)
WFE	void __WFE(void)
WFI	void __WFI(void)

The CMSIS also provides a number of functions for accessing the special registers using MRS and MSR instructions:

Table 25. CMSIS functions to access the special registers

Special register	Access	CMSIS function
PRIMASK	Read	uint32_t __get_PRIMASK (void)
	Write	void __set_PRIMASK (uint32_t value)
FAULTMASK	Read	uint32_t __get_FAULTMASK (void)
	Write	void __set_FAULTMASK (uint32_t value)
BASEPRI	Read	uint32_t __get_BASEPRI (void)
	Write	void __set_BASEPRI (uint32_t value)
CONTROL	Read	uint32_t __get_CONTROL (void)
	Write	void __set_CONTROL (uint32_t value)
MSP	Read	uint32_t __get_MSP (void)
	Write	void __set_MSP (uint32_t TopOfMainStack)
PSP	Read	uint32_t __get_PSP (void)
	Write	void __set_PSP (uint32_t TopOfProcStack)

3.3 About the instruction descriptions

The following sections give more information about using the instructions:

- [Operands on page 63.](#)
- [Restrictions when using PC or SP on page 63.](#)
- [Flexible second operand on page 64.](#)
- [Shift operations on page 65.](#)
- [Address alignment on page 68.](#)
- [PC-relative expressions on page 68.](#)
- [Conditional execution on page 68.](#)
- [Instruction width selection on page 71.](#)

3.3.1 Operands

An instruction operand can be an Arm register, a constant, or another instruction-specific parameter. Instructions act on the operands and often store the result in a destination register. When there is a destination register in the instruction, it is usually specified before the operands.

Operands in some instructions are flexible in that they can either be a register or a constant. See [Flexible second operand on page 64.](#)

3.3.2 Restrictions when using PC or SP

Many instructions have restrictions on whether the user can use the *Program Counter* (PC) or *Stack Pointer* (SP) for the operands or destination register. See instruction descriptions for more information.

Note: Bit[0] of any address written to the PC with a BX, BLX, LDM, LDR, or POP instruction must be 1 for correct execution, because this bit indicates the required instruction set, and the Cortex[®]-M7 processor only supports Thumb instructions.

3.3.3 Flexible second operand

Many general data processing instructions have a flexible second operand. This is shown as *Operand2* in the descriptions of the syntax of each instruction.

Operand2 can be a:

- [Constant](#).
- [Register with optional shift on page 64](#).

Constant

Specify an *Operand2* constant in the form:

#constant

where *constant* can be:

- Any constant that can be produced by shifting an 8-bit value left by any number of bits within a 32-bit word.
- Any constant of the form 0x00XY00XY.
- Any constant of the form 0xXY00XY00.
- Any constant of the form 0xXYXYXYXY.

Note: In these constants, X and Y are hexadecimal digits.

In addition, in a small number of instructions, *constant* can take a wider range of values. These are described in the individual instruction descriptions.

When an *Operand2* constant is used with the instructions MOVS, MVNS, ANDS, ORRS, ORNS, EORS, BICS, TEQ or TST, the carry flag is updated to bit[31] of the constant, if the constant is greater than 255 and can be produced by shifting an 8-bit value. These instructions do not affect the carry flag if *Operand2* is any other constant.

Instruction substitution

The assembler might be able to produce an equivalent instruction if an unpermitted constant is specified. For example, the instruction `CMP Rd, #0xFFFFFFFFE` might be assembled as the equivalent of instruction `CMN Rd, #0x2`.

Register with optional shift

Specify an *Operand2* register in the form:

Rm {, *shift*}

Where:

Rm Is the register holding the data for the second operand.

shift Is an optional shift to be applied to *Rm*. It can be one of:

- ASR #*n* Arithmetic shift right *n* bits, $1 \leq n \leq 32$.
- LSL #*n* Logical shift left *n* bits, $1 \leq n \leq 31$.
- LSR #*n* Logical shift right *n* bits, $1 \leq n \leq 32$.

- ROR #*n* Rotate right *n* bits, $1 \leq n \leq 31$.
- RRX Rotate right one bit, with extend.
- If omitted, no shift occurs, equivalent to LSL #0.

If the shift is omitted or LSL #0 specified, the instruction uses the value in *Rm*.

If the shift is specified, it is applied to the value in *Rm*, and the resulting 32-bit value is used by the instruction. However, the contents in the register *Rm* remain unchanged. Specifying a register with shift also updates the carry flag when used with certain instructions. For information on the shift operations and how they affect the carry flag, see [Shift operations](#).

3.3.4 Shift operations

Register shift operations move the bits in a register left or right by a specified number of bits, the *shift length*. Register shift can be performed:

- Directly by the instructions ASR, LSR, LSL, ROR, and RRX, and the result is written to a destination register.
- During the calculation of *Operand2* by the instructions that specify the second operand as a register with shift, see [Flexible second operand on page 64](#). The result is used by the instruction.

The permitted shift lengths depend on the shift type and the instruction, see the individual instruction description or [Flexible second operand on page 64](#). If the shift length is 0, no shift occurs. Register shift operations update the carry flag except when the specified shift length is 0. The following sub-sections describe the various shift operations and how they affect the carry flag. In these descriptions, *Rm* is the register containing the value to be shifted, and *n* is the shift length.

ASR

Arithmetic shift right by *n* bits moves the left-hand 32-*n* bits of the register *Rm*, to the right by *n* places, into the right-hand 32-*n* bits of the result. And it copies the original bit[31] of the register into the left-hand *n* bits of the result. See [Figure 12 on page 66](#).

The ASR #*n* operation can be used to divide the value in the register *Rm* by 2^n , with the result being rounded towards negative-infinity.

When the instruction is ASRS or when ASR #*n* is used in *Operand2* with the instructions MOVS, MVNS, ANDS, ORRS, ORNS, EORS, BICS, TEQ or TST, the carry flag is updated to the last bit shifted out, bit[*n*-1], of the register *Rm*.

- If *n* is 32 or more, then all the bits in the result are set to the value of bit[31] of *Rm*.
- If *n* is 32 or more and the carry flag is updated, it is updated to the value of bit[31] of *Rm*.

Figure 12. ASR

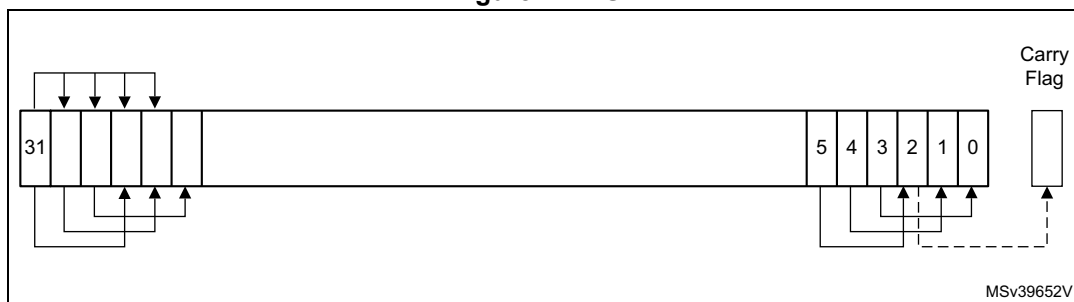

LSR

Logical shift right by n bits moves the left-hand $32-n$ bits of the register Rm , to the right by n places, into the right-hand $32-n$ bits of the result. And it sets the left-hand n bits of the result to 0. See [Figure 13](#).

The LSR $\#n$ operation can be used to divide the value in the register Rm by 2^n , if the value is regarded as an unsigned integer.

When the instruction is LSRS or when LSR $\#n$ is used in *Operand2* with the instructions MOV_S, MVNS, AND_S, ORRS, ORNS, EORS, BICS, TEQ or TST, the carry flag is updated to the last bit shifted out, bit[$n-1$], of the register Rm .

- If n is 32 or more, then all the bits in the result are cleared to 0.
- If n is 33 or more and the carry flag is updated, it is updated to 0.

Figure 13. LSR

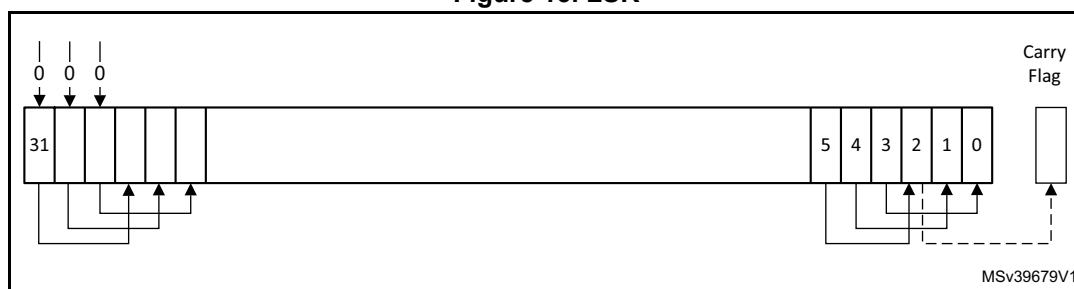

LSL

Logical shift left by n bits moves the right-hand $32-n$ bits of the register Rm , to the left by n places, into the left-hand $32-n$ bits of the result. And it sets the right-hand n bits of the result to 0. See [Figure 14 on page 67](#).

The user can use the LSL $\#n$ operation to multiply the value in the register Rm by 2^n , if the value is regarded as an unsigned integer or a two's complement signed integer. Overflow can occur without warning.

When the instruction is LSLS or when LSL $\#n$, with non-zero n , is used in *Operand2* with the instructions MOV_S, MVNS, AND_S, ORRS, ORNS, EORS, BICS, TEQ or TST, the carry flag is updated to the last bit shifted out, bit[$32-n$], of the register Rm . These instructions do not affect the carry flag when used with LSL $\#0$.

- If n is 32 or more, then all the bits in the result are cleared to 0.
- If n is 33 or more and the carry flag is updated, it is updated to 0.

Figure 14. LSL

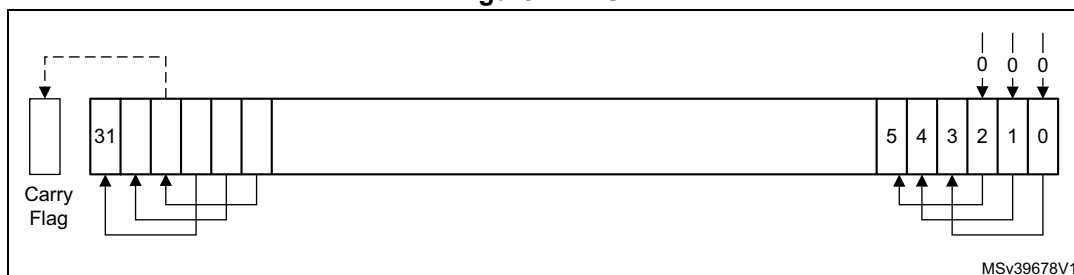

ROR

Rotate right by n bits moves the left-hand $32-n$ bits of the register Rm , to the right by n places, into the right-hand $32-n$ bits of the result. And it moves the right-hand n bits of the register into the left-hand n bits of the result. See [Figure 15](#).

When the instruction is RORS or when ROR $\#n$ is used in *Operand2* with the instructions MOV_S, MVNS, AND_S, ORR_S, ORN_S, EOR_S, BIC_S, TEQ or TST, the carry flag is updated to the last bit rotation, bit[$n-1$], of the register Rm .

- If n is 32, then the value of the result is same as the value in Rm , and if the carry flag is updated, it is updated to bit[31] of Rm .
- ROR with shift length, n , more than 32 is the same as ROR with shift length $n-32$.

Figure 15. ROR

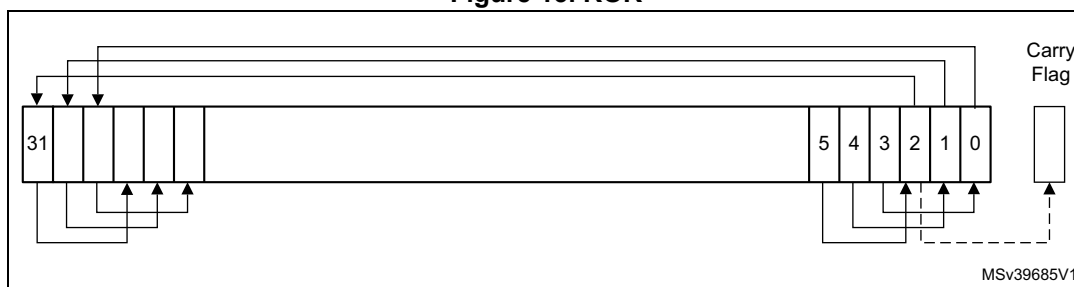

RRX

Rotate right with extend moves the bits of the register Rm to the right by one bit. And it copies the carry flag into bit[31] of the result. See [Figure 16 on page 67](#).

When the instruction is RRXS or when RRX is used in *Operand2* with the instructions MOV_S, MVNS, AND_S, ORR_S, ORN_S, EOR_S, BIC_S, TEQ or TST, the carry flag is updated to bit[0] of the register Rm .

Figure 16. RRX

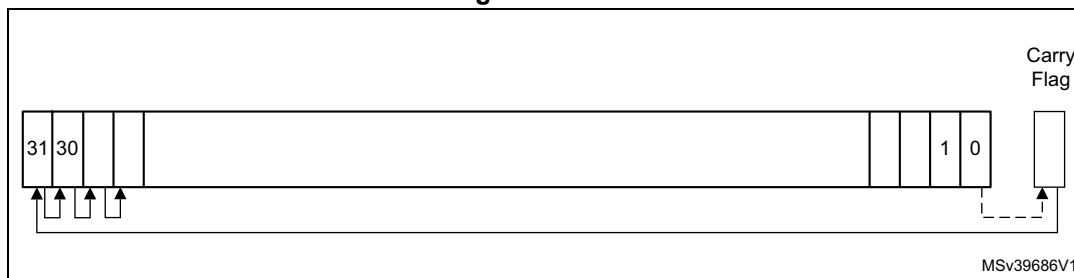

3.3.5 Address alignment

An aligned access is an operation where a word-aligned address is used for a word, dual word, or multiple word access, or where a halfword-aligned address is used for a halfword access. Byte accesses are always aligned.

The Cortex[®]-M7 processor supports unaligned access only for the following instructions:

- LDR, LDRT.
- LDRH, LDRHT.
- LDRSH, LDRSHT.
- STR, STRT.
- STRH, STRHT.

All other load and store instructions generate a UsageFault exception if they perform an unaligned access, and therefore their accesses must be address aligned. For more information about UsageFaults see [Fault handling on page 47](#).

Unaligned accesses are usually slower than aligned accesses. In addition, some memory regions might not support unaligned accesses. Therefore, Arm recommends that programmers ensure that accesses are aligned. To trap accidental generation of unaligned accesses, use the UNALIGN_TRP bit in the Configuration and Control register, see [Configuration and control register on page 200](#).

3.3.6 PC-relative expressions

A PC-relative expression or *label* is a symbol that represents the address of an instruction or literal data. It is represented in the instruction as the PC value plus or minus a numeric offset. The assembler calculates the required offset from the label and the address of the current instruction. If the offset is too big, the assembler produces an error.

- For B, BL, CBNZ, and CBZ instructions, the value of the PC is the address of the current instruction plus 4 bytes.
- For all other instructions that use labels, the value of the PC is the address of the current instruction plus 4 bytes, with bit[1] of the result cleared to 0 to make it word-aligned.
- The assembler might permit other syntaxes for PC-relative expressions, such as a label plus or minus a number, or an expression of the form [PC, #number].

3.3.7 Conditional execution

Most data processing instructions can optionally update the condition flags in the *Application Program Status register* (APSR) according to the result of the operation, see [Application program status register on page 23](#). Some instructions update all flags, and some only update a subset. If a flag is not updated, the original value is preserved. See the instruction descriptions for the flags they affect.

The user can execute an instruction conditionally, based on the condition flags set in another instruction, either:

- Immediately after the instruction that updated the flags.
- After any number of intervening instructions that have not updated the flags.

Conditional execution is available by using conditional branches or by adding condition code suffixes to instructions. See [Table 26 on page 70](#) for a list of the suffixes to add to

instructions to make them conditional instructions. The condition code suffix enables the processor to test a condition based on the flags. If the condition test of a conditional instruction fails, the instruction:

- Does not execute.
- Does not write any value to its destination register.
- Does not affect any of the flags.
- Does not generate any exception.

Conditional instructions, except for conditional branches, must be inside an If-Then instruction block. See [IT on page 148](#) for more information and restrictions when using the IT instruction. Depending on the vendor, the assembler might automatically insert an IT instruction if there are conditional instructions outside the IT block.

Use the CBZ and CBNZ instructions to compare the value of a register against zero and branch on the result.

This section describes:

- [The condition flags on page 69](#).
- [Condition code suffixes on page 70](#).

The condition flags

The APSR contains the following condition flags:

N	Set to 1 when the result of the operation was negative, cleared to 0 otherwise.
Z	Set to 1 when the result of the operation was zero, cleared to 0 otherwise.
C	Set to 1 when the operation resulted in a carry, cleared to 0 otherwise.
V	Set to 1 when the operation caused overflow, cleared to 0 otherwise.

For more information about the APSR see [Program status register on page 22](#).

The C condition flag is set in one of four ways:

- For an addition, including the comparison instruction CMN, C is set to 1 if the addition produced a carry (that is, an unsigned overflow), and to 0 otherwise.
- For a subtraction, including the comparison instruction CMP, C is set to 0 if the subtraction produced a borrow (that is, an unsigned underflow), and to 1 otherwise.
- For non-addition or subtractions that incorporate a shift operation, C is set to the last bit shifted out of the value by the shifter.
- For other non-addition or subtractions, C is normally left unchanged. See the individual instruction descriptions for any special cases.

Overflow occurs when the sign of the result, in bit[31], does not match the sign of the result had the operation been performed at infinite precision, for example:

- If adding two negative values results in a positive value.
- If adding two positive values results in a negative value.
- If subtracting a positive value from a negative value generates a positive value.
- If subtracting a negative value from a positive value generates a negative value.

The Compare operations are identical to subtracting, for CMP, or adding, for CMN, except that the result is discarded. See the instruction descriptions for more information.

Most instructions update the status flags only if the S suffix is specified. See the instruction descriptions for more information.

Condition code suffixes

The instructions that can be conditional have an optional condition code, shown in syntax descriptions as *{cond}*. Conditional execution requires a preceding IT instruction. An instruction with a condition code is only executed if the condition code flags in the APSR meet the specified condition. [Table 26](#) shows the condition codes to use.

The conditional execution can be used with the IT instruction to reduce the number of branch instructions in the code.

[Table 26](#) also shows the relationship between condition code suffixes and the N, Z, C, and V flags.

Table 26. Condition code suffixes

Suffix	Flags	Meaning
EQ	Z = 1	Equal
NE	Z = 0	Not equal
CS or HS	C = 1	Higher or same, unsigned
CC or LO	C = 0	Lower, unsigned
MI	N = 1	Negative
PL	N = 0	Positive or zero
VS	V = 1	Overflow
VC	V = 0	No overflow
HI	C = 1 and Z = 0	Higher, unsigned
LS	C = 0 or Z = 1	Lower or same, unsigned
GE	N = V	Greater than or equal, signed
LT	N != V	Less than, signed
GT	Z = 0 and N = V	Greater than, signed
LE	Z = 1 and N != V	Less than or equal, signed
AL	Can have any value	Always. This is the default when no suffix is specified.

[Example 3-1: absolute value](#) shows the use of a conditional instruction to find the absolute value of a number. $R0 = \text{abs}(R1)$.

Example 3-1: absolute value

```

MOVS    R0, R1        ; R0 = R1, setting flags.
IT      MI            ; Skipping next instruction if value 0 or
                       ; positive.
RSBMI   R0, R0, #0    ; If negative, R0 = -R0.

```

Example 3-2: compare and update value shows the use of conditional instructions to update the value of R4 if the signed values R0 is greater than R1 and R2 is greater than R3.

Example 3-2: compare and update value

```

CMP      R0, R1      ; Compare R0 and R1, setting flags.
ITT      GT          ; Skip next two instructions unless GT condition
                        ; holds.
CMPGT    R2, R3      ; If 'greater than', compare R2 and R3, setting
                        ; flags.
MOVGT    R4, R5      ; If still 'greater than', do R4 = R5.

```

3.3.8 Instruction width selection

There are many instructions that can generate either a 16-bit encoding or a 32-bit encoding depending on the operands and destination register specified. For some of these instructions, a specific instruction size can be forced by using an instruction width suffix. The `.W` suffix forces a 32-bit instruction encoding. The `.N` suffix forces a 16-bit instruction encoding.

If an instruction width suffix is specified and the assembler cannot generate an instruction encoding of the requested width, it generates an error.

In some cases it might be necessary to specify the `.W` suffix, for example if the operand is the label of an instruction or literal data, as in the case of branch instructions. This is because the assembler might not automatically generate the right size encoding.

To use an instruction width suffix, place it immediately after the instruction mnemonic and condition code, if any. *Example 3-3: instruction width selection* shows instructions with the instruction width suffix.

Example 3-3: instruction width selection

```

BCS.W   label       ; Creates a 32-bit instruction even for a short
                        ; branch.

ADDS.W  R0, R0, R1  ; Creates a 32-bit instruction even though the same
                        ; operation can be done by a 16-bit instruction.

```

3.4 Memory access instructions

[Table 27](#) shows the memory access instructions:

Table 27. Memory access instructions

Mnemonic	Brief description	See
ADR	Generate PC-relative address	ADR on page 73
CLREX	Clear Exclusive	CLREX on page 84
LDM{mode}	Load Multiple registers	LDM and STM on page 79
LDR{type}	Load register using immediate offset	LDR and STR, immediate offset on page 73
LDR{type}	Load register using register offset	LDR and STR, register offset on page 76
LDR{type}T	Load register with unprivileged access	LDR and STR, unprivileged on page 77
LDR	Load register using PC-relative address	LDR, PC-relative on page 78
LDRD	Load register Dual	LDR and STR, immediate offset on page 73
LDREX{type}	Load register Exclusive	LDREX and STREX on page 83
PLD	Preload Data.	PLD on page 81
POP	Pop registers from stack	PUSH and POP on page 82
PUSH	Push registers onto stack	PUSH and POP on page 82
STM{mode}	Store Multiple registers	LDM and STM on page 79
STR{type}	Store register using immediate offset	LDR and STR, immediate offset on page 73
STR{type}	Store register using register offset	LDR and STR, register offset on page 76
STR{type}T	Store register with unprivileged access	LDR and STR, unprivileged on page 77
STREX{type}	Store register Exclusive	LDREX and STREX on page 83

3.4.1 ADR

Generate PC-relative address.

Syntax

```
ADR{cond} Rd, label
```

Where:

cond Is an optional condition code. See [Conditional execution on page 68](#).

Rd Is the destination register.

label Is a PC-relative expression. See [PC-relative expressions on page 68](#).

Operation

ADR generates an address by adding an immediate value to the PC, and writes the result to the destination register.

ADR provides the means by which position-independent code can be generated, because the address is PC-relative.

If ADR is used to generate a target address for a BX or BLX instruction, The user must ensure that bit[0] of the address generated is set to 1 for correct execution.

Values of *label* must be within the range of -4095 to +4095 from the address in the PC.

The user might have to use the .W suffix to get the maximum offset range or to generate addresses that are not word-aligned. See [Instruction width selection on page 71](#).

Restrictions

Rd must not be SP and must not be PC.

Condition flags

This instruction does not change the flags.

Examples

```
ADR    R1, TextMessage    ; Write address value of a location labelled
                        ; as TextMessage to R1.
```

3.4.2 LDR and STR, immediate offset

Load and Store with immediate offset, pre-indexed immediate offset, or post-indexed immediate offset.

Syntax

```
op{type}{cond} Rt, [Rn {, #offset}]           ; immediate offset
op{type}{cond} Rt, [Rn, #offset]!           ; pre-indexed
op{type}{cond} Rt, [Rn], #offset            ; post-indexed
opD{cond} Rt, Rt2, [Rn {, #offset}]         ; immediate offset, two words
opD{cond} Rt, Rt2, [Rn, #offset]!         ; pre-indexed, two words
opD{cond} Rt, Rt2, [Rn], #offset           ; post-indexed, two words
```

Where:

<i>op</i>	Is one of: LDR Load register. STR Store register.
<i>type</i>	Is one of: B Unsigned byte, zero extend to 32 bits on loads. SB Signed byte, sign extend to 32 bits (LDR only). H Unsigned halfword, zero extend to 32 bits on loads. SH Signed halfword, sign extend to 32 bits (LDR only). - Omit, for word.
<i>cond</i>	Is an optional condition code. See Conditional execution on page 68 .
<i>Rt</i>	Is the register to load or store.
<i>Rn</i>	Is the register on which the memory address is based.
<i>offset</i>	Is an offset from <i>Rn</i> . If <i>offset</i> is omitted, the address is the contents of <i>Rn</i> .
<i>Rt2</i>	Is the additional register to load or store for two-word operations.

Operation

LDR instructions load one or two registers with a value from memory.

STR instructions store one or two register values to memory.

Load and store instructions with immediate offset can use the following addressing modes:

Offset addressing

The offset value is added to or subtracted from the address obtained from the register *Rn*. The result is used as the address for the memory access. The register *Rn* is unaltered. The assembly language syntax for this mode is:

```
[Rn, #offset]
```

Pre-indexed addressing

The offset value is added to or subtracted from the address obtained from the register *Rn*. The result is used as the address for the memory access and written back into the register *Rn*. The assembly language syntax for this mode is:

```
[Rn, #offset]!
```

Post-indexed addressing

The address obtained from the register *Rn* is used as the address for the memory access. The offset value is added to or subtracted from the address, and written back into the register *Rn*. The assembly language syntax for this mode is:

```
[Rn], #offset
```

The value to load or store can be a byte, halfword, word, or two words. Bytes and halfwords can either be signed or unsigned. See [Address alignment on page 68](#).

[Table 28](#) shows the ranges of offset for immediate, pre-indexed and post-indexed forms

Table 28. Offset ranges

Instruction type	Immediate offset	Pre-indexed	Post-indexed
Word, halfword, signed halfword, byte, or signed byte	-255 to 4095	-255 to 255	-255 to 255
Two words	multiple of 4 in the range -1020 to 1020	multiple of 4 in the range -1020 to 1020	multiple of 4 in the range -1020 to 1020

Restrictions

For load instructions:

- *Rt* can be SP or PC for word loads only.
- *Rt* must be different from *Rt2* for two-word loads.
- *Rn* must be different from *Rt* and *Rt2* in the pre-indexed or post-indexed forms.

When *Rt* is PC in a word load instruction:

- Bit[0] of the loaded value must be 1 for correct execution.
- A branch occurs to the address created by changing bit[0] of the loaded value to 0.
- If the instruction is conditional, it must be the last instruction in the IT block.

For store instructions:

- *Rt* can be SP for word stores only.
- *Rt* must not be PC.
- *Rn* must not be PC.
- *Rn* must be different from *Rt* and *Rt2* in the pre-indexed or post-indexed forms.

Condition flags

These instructions do not change the flags.

Examples

```

LDR    R8, [R10]           ; Loads R8 from the address in R10.
LDRNE  R2, [R5, #960]!    ; Loads (conditionally) R2 from a word
                           ; 960 bytes above the address in R5,
                           ; and increments R5 by 960.
STR    R2, [R9, #const-struct] ; const-struct is an expression
                           ; evaluating to a constant in the range
                           ; 0-4095.
STRH   R3, [R4], #4       ; Store R3 as halfword data into
                           ; address in R4, then increment R4 by
                           ; 4.
LDRD   R8, R9, [R3, #0x20] ; Load R8 from a word 32 bytes above
                           ; the address in R3, and load R9 from a
                           ; word 36 bytes above the address in
                           ; R3.
STRD   R0, R1, [R8], #-16 ; Store R0 to address in R8, and store
                           ; R1 to a word 4 bytes above the
                           ; address in R8, and then decrement R8
                           ; by 16.

```

3.4.3 LDR and STR, register offset

Load and Store with register offset.

Syntax

```
op{type}{cond} Rt, [Rn, Rm {, LSL #n}]
```

Where:

<i>op</i>	Is one of:
	LDR Load register.
	STR Store register.
<i>type</i>	Is one of:
	B Unsigned byte, zero extend to 32 bits on loads.
	SB Signed byte, sign extend to 32 bits (LDR only).
	H Unsigned halfword, zero extend to 32 bits on loads.
	SH Signed halfword, sign extend to 32 bits (LDR only).
	- omit, for word.
<i>cond</i>	Is an optional condition code. See Conditional execution on page 68 .
<i>Rt</i>	Is the register to load or store.
<i>Rn</i>	Is the register on which the memory address is based.
<i>Rm</i>	Is a register containing a value to be used as the offset.
LSL # <i>n</i>	Is an optional shift, with <i>n</i> in the range 0 to 3.

Operation

LDR instructions load a register with a value from memory.

STR instructions store a register value into memory.

The memory address to load from or store to is at an offset from the register *Rn*. The offset is specified by the register *Rm* and can be shifted left by up to 3 bits using LSL.

The value to load or store can be a byte, halfword, or word. For load instructions, bytes and halfwords can either be signed or unsigned. See [Address alignment on page 68](#).

Restrictions

In these instructions:

- *Rn* must not be PC.
- *Rm* must not be SP and must not be PC.
- *Rt* can be SP only for word loads and word stores.
- *Rt* can be PC only for word loads.

When *Rt* is PC in a word load instruction:

- Bit[0] of the loaded value must be 1 for correct execution, and a branch occurs to this halfword-aligned address.
- If the instruction is conditional, it must be the last instruction in the IT block.

Condition flags

These instructions do not change the flags.

Examples

```

STR    R0, [R5, R1]           ; Store value of R0 into an address equal
                               ; to sum of R5 and R1.
LDRSB  R0, [R5, R1, LSL #1]  ; Read byte value from an address equal to
                               ; sum of R5 and two times R1, sign
                               ; extended it to a word value and put it
                               ; in R0.
STR    R0, [R1, R2, LSL #2]  ; Stores R0 to an address equal to sum of
                               ; R1 and four times R2.

```

3.4.4 LDR and STR, unprivileged

Load and Store with unprivileged access.

Syntax

```
op{type}T{cond} Rt, [Rn {, #offset}] ; immediate offset
```

Where:

<i>op</i>	Is one of: LDR Load register. STR Store register.
<i>type</i>	Is one of: B Unsigned byte, zero extend to 32 bits on loads. SB Signed byte, sign extend to 32 bits (LDR only). H Unsigned halfword, zero extend to 32 bits on loads. SH Signed halfword, sign extend to 32 bits (LDR only). - Omit, for word.
<i>cond</i>	Is an optional condition code. See Conditional execution on page 68 .
<i>Rt</i>	Is the register to load or store.
<i>Rn</i>	Is the register on which the memory address is based.
<i>offset</i>	Is an offset from <i>Rn</i> and can be 0 to 255. If <i>offset</i> is omitted, the address is the value in <i>Rn</i> .

Operation

These load and store instructions perform the same function as the memory access instructions with immediate offset, see [LDR and STR, immediate offset on page 73](#). The difference is that these instructions have only unprivileged access even when used in privileged software.

When used in unprivileged software, these instructions behave in exactly the same way as normal memory access instructions with immediate offset.

Restrictions

In these instructions:

- *Rn* must not be PC.
- *Rt* must not be SP and must not be PC.

Condition flags

These instructions do not change the flags.

Examples

```

STRBTEQ R4, [R7] ; Conditionally store least significant byte
                ; in R4 to an address in R7, with unprivileged
                ; access.
LDRHT R2, [R2, #8] ; Load halfword value from an address equal to
                  ; sum of R2 and 8 into R2, with unprivileged
                  ; access.
    
```

3.4.5 LDR, PC-relative

Load register from memory.

Syntax

```

LDR{type}{cond} Rt, label
LDRD{cond} Rt, Rt2, label ; Load two words
    
```

Where:

- type* Is one of:
 - B Unsigned byte, zero extend to 32 bits.
 - SB Signed byte, sign extend to 32 bits.
 - H Unsigned halfword, zero extend to 32 bits.
 - SH Signed halfword, sign extend to 32 bits.
 - Omit, for word.
- cond* Is an optional condition code. See [Conditional execution on page 68](#).
- Rt* Is the register to load or store.
- Rt2* Is the second register to load or store.
- label* Is a PC-relative expression. See [PC-relative expressions on page 68](#).

Operation

LDR loads a register with a value from a PC-relative memory address. The memory address is specified by a label or by an offset from the PC.

The value to load or store can be a byte, halfword, or word. For load instructions, bytes and halfwords can either be signed or unsigned. See [Address alignment on page 68](#).

label must be within a limited range of the current instruction. [Table 29](#) shows the possible offsets between *label* and the PC

Table 29. Offset ranges

Instruction type	Offset range
Word, halfword, signed halfword, byte, signed byte	-4095 to 4095
Two words	-1020 to 1020

Note: The user might have to use the `.w` suffix to get the maximum offset range. See [Instruction width selection on page 71](#).

Restrictions

In these instructions:

- *Rt* can be SP or PC only for word loads.
- *Rt2* must not be SP and must not be PC.
- *Rt* must be different from *Rt2*.

When *Rt* is PC in a word load instruction:

- Bit[0] of the loaded value must be 1 for correct execution, and a branch occurs to this halfword-aligned address.
- If the instruction is conditional, it must be the last instruction in the IT block.

Condition flags

These instructions do not change the flags.

Examples

```
LDR    R0, LookUpTable    ; Load R0 with a word of data from an
                          ; address labelled as LookUpTable.
LDRSB  R7, localdata      ; Load a byte value from an address labelled
                          ; as localdata, sign extend it to a word
                          ; value, and put it in R7.
```

3.4.6 LDM and STM

Load and Store Multiple registers.

Syntax

```
op{addr_mode}{cond} Rn{!}, reglist
```

Where:

<i>op</i>	Is one of:
LDM	Load Multiple registers.
STM	Store Multiple registers.
<i>addr_mode</i>	Is any one of the following:
IA	Increment address After each access. This is the default.
DB	Decrement address Before each access.
<i>cond</i>	Is an optional condition code. See Conditional execution on page 68 .
<i>Rn</i>	Is the register on which the memory addresses are based.
!	Is an optional writeback suffix. If ! is present the final address, that is loaded from or stored to, is written back into <i>Rn</i> .
<i>reglist</i>	Is a list of one or more registers to be loaded or stored, enclosed in braces. It can contain register ranges. It must be comma separated if it contains more than one register or register range, see Examples on page 80 .

LDM and LDMFD are synonyms for LDMIA. LDMFD refers to its use for popping data from Full Descending stacks.

LDMEA is a synonym for LDMDB, and refers to its use for popping data from Empty Ascending stacks.

STM and STMEA are synonyms for STMIA. STMEA refers to its use for pushing data onto Empty Ascending stacks.

STMFD is a synonym for STMDB, and refers to its use for pushing data onto Full Descending stacks

Operation

LDM instructions load the registers in *reglist* with word values from memory addresses based on *Rn*.

STM instructions store the word values in the registers in *reglist* to memory addresses based on *Rn*.

For LDM, LDMIA, LDMFD, STM, STMIA, and STMEA the memory addresses used for the accesses are at 4-byte intervals ranging from Rn to $Rn + 4 * (n-1)$, where n is the number of registers in *reglist*. The accesses happen in order of increasing register numbers, with the lowest numbered register using the lowest memory address and the highest number register using the highest memory address. If the writeback suffix is specified, the value of $Rn + 4 * (n-1)$ is written back to *Rn*.

For LDMDB, LDMEA, STMDB, and STMFD the memory addresses used for the accesses are at 4-byte intervals ranging from Rn to $Rn - 4 * (n-1)$, where n is the number of registers in *reglist*. The accesses happen in order of decreasing register numbers, with the highest numbered register using the highest memory address and the lowest number register using the lowest memory address. If the writeback suffix is specified, the value of $Rn - 4 * (n-1)$ is written back to *Rn*.

The PUSH and POP instructions can be expressed in this form. See [PUSH and POP on page 82](#) for details.

Restrictions

In these instructions:

- *Rn* must not be PC.
- *reglist* must not contain SP.
- In any STM instruction, *reglist* must not contain PC.
- In any LDM instruction, *reglist* must not contain PC if it contains LR.
- *reglist* must not contain *Rn* if the writeback suffix is specified.

When PC is in *reglist* in an LDM instruction:

- Bit[0] of the value loaded to the PC must be 1 for correct execution, and a branch occurs to this halfword-aligned address
- If the instruction is conditional, it must be the last instruction in the IT block.

Condition flags

These instructions do not change the flags.

Examples

```
LDM      R8, {R0, R2, R9}      ; LDMIA is a synonym for LDM.
STMDB   R1!, {R3-R6, R11, R12}
```

Incorrect examples

```

STM      R5!, {R5,R4,R9} ; Value stored for R5 is unpredictable.
LDM      R2, {}          ; There must be at least one register in the
                        ; list.

```

3.4.7 PLD

Preload Data.

Syntax

```
PLD [<Rn>, #<imm12>]
```

```
PLD [<Rn>, <Rm> {, LSL #<shift>}]
```

```
PLD <label>
```

where:

<Rn> Is the base register.

<imm> Is the immediate offset used to form the address.

<Rm> Is the optionally shifted offset register.

<shift> Specifies the shift to apply to the value read from <Rm>, in the range 0-3. If this option is omitted, a shift by 0 is assumed.

<label> The label of the literal item that is likely to be accessed in the near future.

Operation

PLD signals the memory system that data memory accesses from a specified address are likely in the near future. If the address is cacheable then the memory system responds by pre-loading the cache line containing the specified address into the data cache. If the address is not cacheable, or the data cache is disabled, this instruction behaves as no operation.

Restrictions

There are no restrictions.

Condition flags

These instructions do not change the flags.

3.4.8 PUSH and POP

Push registers onto, and pop registers off a full-descending stack.

Syntax

PUSH{*cond*} *reglist*

POP{*cond*} *reglist*

Where:

cond Is an optional condition code. See [Conditional execution on page 68](#).

reglist Is a non-empty list of registers, enclosed in braces. It can contain register ranges. It must be comma separated if it contains more than one register or register range.

PUSH and POP are synonyms for STMDB and LDM (or LDMIA) with the memory addresses for the access based on SP, and with the final address for the access written back to the SP. PUSH and POP are the preferred mnemonics in these cases.

Operation

PUSH stores registers on the stack, with the lowest numbered register using the lowest memory address and the highest numbered register using the highest memory address.

POP loads registers from the stack, with the lowest numbered register using the lowest memory address and the highest numbered register using the highest memory address.

PUSH uses the value in the SP register minus four as the highest memory address, POP uses the value in the SP register as the lowest memory address, implementing a full-descending stack. On completion, PUSH updates the SP register to point to the location of the lowest store value, POP updates the SP register to point to the location above the highest location loaded.

If a POP instruction includes PC in its *reglist*, a branch to this location is performed when the POP instruction has completed. Bit[0] of the value read for the PC is used to update the APSR T-bit. This bit must be 1 to ensure correct operation.

See [LDM and STM on page 79](#) for more information.

Restrictions

In these instructions:

- *reglist* must not contain SP.
- For the PUSH instruction, *reglist* must not contain PC.
- For the POP instruction, *reglist* must not contain PC if it contains LR.

When PC is in *reglist* in a POP instruction:

- Bit[0] of the value loaded to the PC must be 1 for correct execution, and a branch occurs to this halfword-aligned address.
- If the instruction is conditional, it must be the last instruction in the IT block.

Condition flags

These instructions do not change the flags.

Examples

```
PUSH {R0,R4-R7} ; Push R0,R4,R5,R6,R7 onto the stack
PUSH {R2,LR}    ; Push R2 and the link-register onto the stack
POP {R0,R6,PC} ; Pop r0,r6 and PC from the stack, then branch to the
                ; new PC.
```

3.4.9 LDREX and STREX

Load and Store Register Exclusive.

Syntax

```
LDREX{cond} Rt, [Rn {, #offset}]
STREX{cond} Rd, Rt, [Rn {, #offset}]
LDREXB{cond} Rt, [Rn]
STREXB{cond} Rd, Rt, [Rn]
LDREXH{cond} Rt, [Rn]
STREXH{cond} Rd, Rt, [Rn]
```

Where:

<i>cond</i>	Is an optional condition code. See Conditional execution on page 68 .
<i>Rd</i>	Is the destination register for the returned status.
<i>Rt</i>	Is the register to load or store.
<i>Rn</i>	Is the register on which the memory address is based.
<i>offset</i>	Is an optional offset applied to the value in <i>Rn</i> . If <i>offset</i> is omitted, the address is the value in <i>Rn</i> .

Operation

LDREX, LDREXB, and LDREXH load a word, byte, and halfword respectively from a memory address.

STREX, STREXB, and STREXH attempt to store a word, byte, and halfword respectively to a memory address. The address used in any Store-Exclusive instruction must be the same as the address in the most recently executed Load-exclusive instruction. The value stored by the Store-Exclusive instruction must also have the same data size as the value loaded by the preceding Load-exclusive instruction. This means software must always use a Load-exclusive instruction and a matching Store-Exclusive instruction to perform a synchronization operation, see [Synchronization primitives on page 37](#).

If a Store-Exclusive instruction performs the store, it writes 0 to its destination register. If it does not perform the store, it writes 1 to its destination register. If the Store-Exclusive instruction writes 0 to the destination register, it is guaranteed that no other process in the system has accessed the memory location between the Load-exclusive and Store-Exclusive instructions.

For reasons of performance, keep the number of instructions between corresponding Load-Exclusive and Store-Exclusive instruction to a minimum.

The result of executing a Store-Exclusive instruction to an address that is different from that used in the preceding Load-Exclusive instruction is unpredictable.

Restrictions

In these instructions:

- Do not use PC.
- Do not use SP for *Rd* and *Rt*.
- For STREX, *Rd* must be different from both *Rt* and *Rn*.
- The value of *offset* must be a multiple of four in the range 0-1020.

Condition flags

These instructions do not change the flags.

Examples

```

MOV      R1, #0x1           ; Initialize the 'lock taken' value try
LDREX   R0, [LockAddr]     ; Load the lock value
CMP      R0, #0             ; Is the lock free?
ITT      EQ                 ; IT instruction for STREXEQ and CMPEQ
STREXEQ R0, R1, [LockAddr] ; Try and claim the lock
CMPEQ   R0, #0             ; Did this succeed?
BNE     try                 ; No - try again
....    ; Yes - we have the lock.

```

3.4.10 CLREX

Clear Exclusive.

Syntax

```
CLREX{ cond }
```

Where:

cond Is an optional condition code. See [Conditional execution on page 68](#).

Operation

Use CLREX to make the next STREX, STREXB, or STREXH instruction write 1 to its destination register and fail to perform the store. It is useful in exception handler code to force the failure of the store exclusive if the exception occurs between a load exclusive instruction and the matching store exclusive instruction in a synchronization operation.

See [Synchronization primitives on page 37](#) for more information.

Condition flags

This instruction does not change the flags.

Examples

```
CLREX
```

3.5 General data processing instructions

[Table 30](#) shows the data processing instructions:

Table 30. Data processing instructions

Mnemonic	Brief description	See
ADC	Add with Carry	ADD, ADC, SUB, SBC, and RSB on page 87
ADD	Add	ADD, ADC, SUB, SBC, and RSB on page 87
ADDW	Add	ADD, ADC, SUB, SBC, and RSB on page 87
AND	Logical AND	AND, ORR, EOR, BIC, and ORN on page 89
ASR	Arithmetic Shift Right	ASR, LSL, LSR, ROR, and RRX on page 90
BIC	Bit Clear	AND, ORR, EOR, BIC, and ORN on page 89
CLZ	Count leading zeros	CLZ on page 91
CMN	Compare Negative	CMP and CMN on page 92
CMP	Compare	CMP and CMN on page 92
EOR	Exclusive OR	AND, ORR, EOR, BIC, and ORN on page 89
LSL	Logical Shift Left	ASR, LSL, LSR, ROR, and RRX on page 90
LSR	Logical Shift Right	ASR, LSL, LSR, ROR, and RRX on page 90
MOV	Move	MOV and MVN on page 93
MOVT	Move Top	MOVT on page 94
MOVW	Move 16-bit constant	MOV and MVN on page 93
MVN	Move NOT	MOV and MVN on page 93
ORN	Logical OR NOT	AND, ORR, EOR, BIC, and ORN on page 89
ORR	Logical OR	AND, ORR, EOR, BIC, and ORN on page 89
RBIT	Reverse Bits	REV, REV16, REVSH, and RBIT on page 95
REV	Reverse byte order in a word	REV, REV16, REVSH, and RBIT on page 95
REV16	Reverse byte order in each halfword	REV, REV16, REVSH, and RBIT on page 95
REVSH	Reverse byte order in bottom halfword and sign extend	REV, REV16, REVSH, and RBIT on page 95
ROR	Rotate Right	ASR, LSL, LSR, ROR, and RRX on page 90
RRX	Rotate Right with Extend	ASR, LSL, LSR, ROR, and RRX on page 90
RSB	Reverse Subtract	ADD, ADC, SUB, SBC, and RSB on page 87
SADD16	Signed Add 16	SADD16 and SADD8 on page 96
SADD8	Signed Add 8	SADD16 and SADD8 on page 96
SASX	Signed Add and Subtract with Exchange	SASX and SSAX on page 101
SSAX	Signed Subtract and Add with Exchange	SASX and SSAX on page 101
SBC	Subtract with Carry	ADD, ADC, SUB, SBC, and RSB on page 87
SHADD16	Signed Halving Add 16	SHADD16 and SHADD8 on page 97

Table 30. Data processing instructions (continued)

Mnemonic	Brief description	See
SHADD8	Signed Halving Add 8	SHADD16 and SHADD8 on page 97
SHASX	Signed Halving Add and Subtract with Exchange	SHASX and SHSAX on page 98
SHSAX	Signed Halving Subtract and Add with Exchange	SHASX and SHSAX on page 98
SHSUB16	Signed Halving Subtract 16	SHSUB16 and SHSUB8 on page 99
SHSUB8	Signed Halving Subtract 8	SHSUB16 and SHSUB8 on page 99
SSUB16	Signed Subtract 16	SSUB16 and SSUB8 on page 100
SSUB8	Signed Subtract 8	SSUB16 and SSUB8 on page 100
SUB	Subtract	ADD, ADC, SUB, SBC, and RSB on page 87
SUBW	Subtract	ADD, ADC, SUB, SBC, and RSB on page 87
TEQ	Test Equivalence	TST and TEQ on page 102
TST	Test	TST and TEQ on page 102
UADD16	Unsigned Add 16	UADD16 and UADD8 on page 103
UADD8	Unsigned Add 8	UADD16 and UADD8 on page 103
UASX	Unsigned Add and Subtract with Exchange	UASX and USAX on page 104
USAX	Unsigned Subtract and Add with Exchange	UASX and USAX on page 104
UHADD16	Unsigned Halving Add 16	UHADD16 and UHADD8 on page 105
UHADD8	Unsigned Halving Add 8	UHADD16 and UHADD8 on page 105
UHASX	Unsigned Halving Add and Subtract with Exchange	UHASX and UHSAX on page 106
UHSAX	Unsigned Halving Subtract and Add with Exchange	UHASX and UHSAX on page 106
UHSUB16	Unsigned Halving Subtract 16	UHSUB16 and UHSUB8 on page 107
UHSUB8	Unsigned Halving Subtract 8	UHSUB16 and UHSUB8 on page 107
USAD8	Unsigned Sum of Absolute Differences	USAD8 on page 108
USADA8	Unsigned Sum of Absolute Differences and Accumulate	USADA8 on page 109
USUB16	Unsigned Subtract 16	USUB16 and USUB8 on page 110
USUB8	Unsigned Subtract 8	USUB16 and USUB8 on page 110

3.5.1 ADD, ADC, SUB, SBC, and RSB

Add, Add with carry, Subtract, Subtract with carry, and Reverse Subtract.

Syntax

```
op{S}{cond} {Rd,} Rn, Operand2
op{cond} {Rd,} Rn, #imm12 ; ADD and SUB only
```

Where:

<i>op</i>	Is one of: ADD Add. ADC Add with Carry. SUB Subtract. SBC Subtract with Carry. RSB Reverse Subtract.
<i>S</i>	Is an optional suffix. If <i>s</i> is specified, the condition code flags are updated on the result of the operation, see Conditional execution on page 68 .
<i>cond</i>	Is an optional condition code. See Conditional execution on page 68 .
<i>Rd</i>	Is the destination register. If <i>Rd</i> is omitted, the destination register is <i>Rn</i> .
<i>Rn</i>	Is the register holding the first operand.
<i>Operand2</i>	Is a flexible second operand. See Flexible second operand on page 64 for details of the options.
<i>imm12</i>	Is any value in the range 0-4095.

Operation

The ADD instruction adds the value of *Operand2* or *imm12* to the value in *Rn*.

The ADC instruction adds the values in *Rn* and *Operand2*, together with the carry flag.

The SUB instruction subtracts the value of *Operand2* or *imm12* from the value in *Rn*.

The SBC instruction subtracts the value of *Operand2* from the value in *Rn*. If the carry flag is clear, the result is reduced by one.

The RSB instruction subtracts the value in *Rn* from the value of *Operand2*. This is useful because of the wide range of options for *Operand2*.

Use ADC and SBC to synthesize multiword arithmetic, see [Multiword arithmetic examples on page 88](#).

See also [ADR on page 73](#).

ADDW is equivalent to the ADD syntax that uses the *imm12* operand. SUBW is equivalent to the SUB syntax that uses the *imm12* operand.

Restrictions

In these instructions:

- *Operand2* must not be SP and must not be PC
- *Rd* can be SP only in ADD and SUB, and only with the additional restrictions:
 - *Rn* must also be SP.
 - Any shift in *Operand2* must be limited to a maximum of 3 bits using LSL.
- *Rn* can be SP only in ADD and SUB
- *Rd* can be PC only in the ADD{*cond*} PC, PC, Rm instruction where:
 - The S suffix must not be specified.
 - *Rm* must not be PC and must not be SP.
 - If the instruction is conditional, it must be the last instruction in the IT block.
- With the exception of the ADD{*cond*} PC, PC, Rm instruction, *Rn* can be PC only in ADD and SUB, and only with the additional restrictions:
 - The S suffix must not be specified.
 - The second operand must be a constant in the range 0 to 4095.
 - When using the PC for an addition or a subtraction, bits[1:0] of the PC are rounded to 0b00 before performing the calculation, making the base address for the calculation word-aligned.
 - If the user wants to generate the address of an instruction, the constant has to be adjusted based on the value of the PC. Arm recommends using the ADR instruction instead of ADD or SUB with *Rn* equal to the PC, because the assembler automatically calculates the correct constant for the ADR instruction.

When *Rd* is PC in the ADD{*cond*} PC, PC, Rm instruction:

- Bit[0] of the value written to the PC is ignored.
- A branch occurs to the address created by forcing bit[0] of that value to 0.

Condition flags

If *s* is specified, these instructions update the N, Z, C and V flags according to the result.

Examples

```

ADD    R2, R1, R3
SUBS   R8, R6, #240      ; Sets the flags on the result.
RSB    R4, R4, #1280     ; Subtracts contents of R4 from 1280.
ADCHI  R11, R0, R3      ; Only executed if C flag set and Z.
                               ; flag clear.

```

Multiword arithmetic examples

[Example 3-4: 64-bit addition](#) shows two instructions that add a 64-bit integer contained in R2 and R3 to another 64-bit integer contained in R0 and R1, and place the result in R4 and R5.

Example 3-4: 64-bit addition

```

ADDS   R4, R0, R2      ; Add the least significant words.
ADC    R5, R1, R3      ; Add the most significant words with carry.

```

The multiword values do not have to use consecutive registers. [Example 3-5: 96-bit](#)

subtraction shows instructions that subtract a 96-bit integer contained in R9, R1, and R11 from another contained in R6, R2, and R8. The example stores the result in R6, R9, and R2.

Example 3-5: 96-bit subtraction

```

SUBS    R6, R6, R9    ; Subtract the least significant words.
SBCS    R9, R2, R1    ; Subtract the middle words with carry.
SBC     R2, R8, R11   ; Subtract the most significant words with
                       ; carry.

```

3.5.2 AND, ORR, EOR, BIC, and ORN

Logical AND, OR, Exclusive OR, Bit Clear, and OR NOT.

Syntax

op{*S*}{*cond*} {*Rd*,} *Rn*, *Operand2*

Where:

<i>op</i>	Is one of:
AND	Logical AND.
ORR	Logical OR, or bit set.
EOR	Logical Exclusive OR.
BIC	Logical AND NOT, or bit clear.
ORN	Logical OR NOT.
<i>S</i>	Is an optional suffix. If <i>S</i> is specified, the condition code flags are updated on the result of the operation, see Conditional execution on page 68 .
<i>cond</i>	Is an optional condition code. See Conditional execution on page 68 .
<i>Rd</i>	Is the destination register.
<i>Rn</i>	Is the register holding the first operand.
<i>Operand2</i>	Is a flexible second operand. See Flexible second operand on page 64 for details of the options.

Operation

The AND, EOR, and ORR instructions perform bitwise AND, Exclusive OR, and OR operations on the values in *Rn* and *Operand2*.

The BIC instruction performs an AND operation on the bits in *Rn* with the complements of the corresponding bits in the value of *Operand2*.

The ORN instruction performs an OR operation on the bits in *Rn* with the complements of the corresponding bits in the value of *Operand2*.

Restrictions

Do not use SP and do not use PC.

Condition flags

If S is specified, these instructions:

- Update the N and Z flags according to the result.
- Can update the C flag during the calculation of *Operand2*, see [Example 3-5: 96-bit subtraction on page 89](#).
- Do not affect the V flag.

Examples

```

AND      R9, R2, #0xFF00
ORREQ   R2, R0, R5
ANDS    R9, R8, #0x19
EORS    R7, R11, #0x18181818
BIC     R0, R1, #0xab
ORN     R7, R11, R14, ROR #4
ORNS   R7, R11, R14, ASR #32

```

3.5.3 ASR, LSL, LSR, ROR, and RRX

Arithmetic Shift Right, Logical Shift Left, Logical Shift Right, Rotate Right, and Rotate Right with Extend.

Syntax

op{*S*}{*cond*} *Rd*, *Rm*, *Rs*

op{*S*}{*cond*} *Rd*, *Rm*, #*n*

RRX{*S*}{*cond*} *Rd*, *Rm*

Where:

op Is one of:

ASR	Arithmetic Shift Right.
LSL	Logical Shift Left.
LSR	Logical Shift Right.
ROR	Rotate Right.

S Is an optional suffix. If *S* is specified, the condition code flags are updated on the result of the operation, see [Conditional execution on page 68](#).

Rd Is the destination register.

Rm Is the register holding the value to be shifted.

Rs Is the register holding the shift length to apply to the value in *Rm*. Only the least significant byte is used and can be in the range 0 to 255.

n Is the shift length. The range of shift length depends on the instruction:

ASR	Shift length from 1 to 32
LSL	Shift length from 0 to 31
LSR	Shift length from 1 to 32
ROR	Shift length from 1 to 31

MOVS *Rd*, *Rm* is the preferred syntax for LSL *Rd*, *Rm*, #0.

Operation

ASR, LSL, LSR, and ROR move the bits in the register *Rm* to the left or right by the number of places specified by constant *n* or register *Rs*.

RRX moves the bits in register *Rm* to the right by 1.

In all these instructions, the result is written to *Rd*, but the value in register *Rm* remains unchanged. For details on what result is generated by the different instructions, see [Shift operations on page 65](#).

Restrictions

Do not use SP and do not use PC.

Condition flags

If S is specified:

- These instructions update the N and Z flags according to the result.
- The C flag is updated to the last bit shifted out, except when the shift length is 0, see [Shift operations on page 65](#).

Examples

```
ASR    R7, R8, #9 ; Arithmetic shift right by 9 bits.
LSLS   R1, R2, #3 ; Logical shift left by 3 bits with flag update.
LSR    R4, R5, #6 ; Logical shift right by 6 bits.
ROR    R4, R5, R6 ; Rotate right by the value in the bottom byte of
                ; R6.
RRX    R4, R5 ; Rotate right with extend.
```

3.5.4 CLZ

Count Leading Zeros.

Syntax

```
CLZ{cond} Rd, Rm
```

Where:

cond Is an optional condition code. See [Conditional execution on page 68](#).
Rd Is the destination register.
Rm Is the operand register.

Operation

The CLZ instruction counts the number of leading zeros in the value in *Rm* and returns the result in *Rd*. The result value is 32 if no bits are set and zero if bit[31] is set.

Restrictions

Do not use SP and do not use PC.

Condition flags

This instruction does not change the flags.

Examples

```

CLZ      R4, R9
CLZNE   R2, R3

```

3.5.5 CMP and CMN

Compare and Compare Negative.

Syntax

```
CMP{cond} Rn, Operand2
```

```
CMN{cond} Rn, Operand2
```

Where:

cond Is an optional condition code. See [Conditional execution on page 68](#).

Rn Is the register holding the first operand.

Operand2 Is a flexible second operand. See [Flexible second operand on page 64](#) for details of the options.

Operation

These instructions compare the value in a register with *Operand2*. They update the condition flags on the result, but do not write the result to a register.

The CMP instruction subtracts the value of *Operand2* from the value in *Rn*. This is the same as a SUBS instruction, except that the result is discarded.

The CMN instruction adds the value of *Operand2* to the value in *Rn*. This is the same as an ADDS instruction, except that the result is discarded.

Restrictions

In these instructions:

- Do not use PC.
- *Operand2* must not be SP.

Condition flags

These instructions update the N, Z, C and V flags according to the result.

Examples

```

CMP      R2, R9
CMN      R0, #6400
CMPGT    SP, R7, LSL #2

```

3.5.6 MOV and MVN

Move and Move NOT.

Syntax

`MOV{S}{cond} Rd, Operand2`

`MOV{cond} Rd, #imm16`

`MVN{S}{cond} Rd, Operand2`

Where:

- S* Is an optional suffix. If *S* is specified, the condition code flags are updated on the result of the operation, see [Conditional execution on page 68](#).
- cond* Is an optional condition code. See [Conditional execution on page 68](#).
- Rd* Is the destination register.
- Operand2* Is a flexible second operand. See [Flexible second operand on page 64](#) for details of the options.
- imm16* Is any value in the range 0-65535.

Operation

The MOV instruction copies the value of *Operand2* into *Rd*.

When *Operand2* in a MOV instruction is a register with a shift other than LSL #0, the preferred syntax is the corresponding shift instruction:

- `ASR{S}{cond} Rd, Rm, #n` is the preferred syntax for `MOV{S}{cond} Rd, Rm, ASR #n`.
- `LSL{S}{cond} Rd, Rm, #n` is the preferred syntax for `MOV{S}{cond} Rd, Rm, LSL #n if n != 0`.
- `LSR{S}{cond} Rd, Rm, #n` is the preferred syntax for `MOV{S}{cond} Rd, Rm, LSR #n`.
- `ROR{S}{cond} Rd, Rm, #n` is the preferred syntax for `MOV{S}{cond} Rd, Rm, ROR #n`.
- `RRX{S}{cond} Rd, Rm` is the preferred syntax for `MOV{S}{cond} Rd, Rm, RRX`.

Also, the MOV instruction permits additional forms of *Operand2* as synonyms for shift instructions:

- `MOV{S}{cond} Rd, Rm, ASR Rs` is a synonym for `ASR{S}{cond} Rd, Rm, Rs`.
- `MOV{S}{cond} Rd, Rm, LSL Rs` is a synonym for `LSL{S}{cond} Rd, Rm, Rs`.
- `MOV{S}{cond} Rd, Rm, LSR Rs` is a synonym for `LSR{S}{cond} Rd, Rm, Rs`.
- `MOV{S}{cond} Rd, Rm, ROR Rs` is a synonym for `ROR{S}{cond} Rd, Rm, Rs`.

See [ASR, LSL, LSR, ROR, and RRX on page 90](#).

The MVN instruction takes the value of *Operand2*, performs a bitwise logical NOT operation on the value, and places the result into *Rd*.

The MOVW instruction provides the same function as MOV, but is restricted to using the *imm16* operand.

Restrictions

The user can use SP and PC only in the MOV instruction, with the following restrictions:

- The second operand must be a register without shift.
- The S suffix must not be specified.

When *Rd* is PC in a MOV instruction:

- Bit[0] of the value written to the PC is ignored.
- A branch occurs to the address created by forcing bit[0] of that value to 0.

Though it is possible to use MOV as a branch instruction, Arm strongly recommends the use of a BX or BLX instruction to branch for software portability to the Arm instruction set.

Condition flags

If S is specified, these instructions:

- Update the N and Z flags according to the result.
- Can update the C flag during the calculation of *Operand2*, see [Flexible second operand on page 64](#).
- Do not affect the V flag.

Example

```

MOVS  R11, #0x000B    ; Write value of 0x000B to R11, flags get
                        ; updated.
MOV   R1, #0xFA05    ; Write value of 0xFA05 to R1, flags are not
                        ; updated.
MOVS  R10, R12       ; Write value in R12 to R10, flags get updated.
MOV   R3, #23        ; Write value of 23 to R3.
MOV   R8, SP         ; Write value of stack pointer to R8.
MVNS  R2, #0xF       ; Write value of 0xFFFFFFFF0 (bitwise inverse of
                        ; 0xF) to the R2 and update flags.

```

3.5.7 MOVT

Move Top.

Syntax

```
MOVT{cond} Rd, #imm16
```

Where:

cond Is an optional condition code. See [Conditional execution on page 68](#).
Rd Is the destination register.
imm16 Is a 16-bit immediate constant.

Operation

MOVT writes a 16-bit immediate value, *imm16*, to the top halfword, *Rd*[31:16], of its destination register. The write does not affect *Rd*[15:0].

The MOV, MOVT instruction pair enables to generate any 32-bit constant.

Restrictions

Rd must not be SP and must not be PC.

Condition flags

This instruction does not change the flags.

Examples

```
MOVT    R3, #0xF123 ; Write 0xF123 to upper halfword of R3, lower
                ; halfword and APSR are unchanged.
```

3.5.8 REV, REV16, REVSH, and RBIT

Reverse bytes and Reverse bits.

Syntax

op{*cond*} *Rd*, *Rn*

Where:

<i>op</i>	Is one of:
REV	Reverse byte order in a word.
REV16	Reverse byte order in each halfword independently.
REVSH	Reverse byte order in the bottom halfword, and sign extend to 32 bits.
RBIT	Reverse the bit order in a 32-bit word.
<i>cond</i>	Is an optional condition code. See Conditional execution on page 68 .
<i>Rd</i>	Is the destination register.
<i>Rn</i>	Is the register holding the operand.

Operation

Use these instructions to change endianness of data:

REV	converts either: <ul style="list-style-type: none"> 32-bit big-endian data into little-endian data. 32-bit little-endian data into big-endian data.
REV16	converts either: <ul style="list-style-type: none"> 16-bit big-endian data into little-endian data. 16-bit little-endian data into big-endian data.
REVSH	converts either: <ul style="list-style-type: none"> 16-bit signed big-endian data into 32-bit signed little-endian data. 16-bit signed little-endian data into 32-bit signed big-endian data.

Restrictions

Do not use SP and do not use PC.

Condition flags

These instructions do not change the flags.

Examples

```

REV    R3, R7 ; Reverse byte order of value in R7 and write it to R3.
REV16 R0, R0 ; Reverse byte order of each 16-bit halfword in R0.
REVSH R0, R5 ; Reverse Signed Halfword.
REVHS R3, R7 ; Reverse with Higher or Same condition.
RBIT  R7, R8 ; Reverse bit order of value in R8 and write the result
           ; to R7.

```

3.5.9 SADD16 and SADD8

Signed Add 16 and Signed Add 8.

Syntax

```
op{cond} {Rd,} Rn, Rm
```

Where:

op Is one of:

- SADD16 Performs two 16-bit signed integer additions.
- SADD8 Performs four 8-bit signed integer additions.

cond Is an optional condition code. See [Conditional execution on page 68](#).

Rd Is the destination register.

Rn Is the first register holding the operand.

Rm Is the second register holding the operand.

Operation

Use these instructions to perform a halfword or byte add in parallel.

The SADD16 instruction:

1. Adds each halfword from the first operand to the corresponding halfword of the second operand.
2. Writes the result in the corresponding halfwords of the destination register.

The SADD8 instruction:

1. Adds each byte of the first operand to the corresponding byte of the second operand.
2. Writes the result in the corresponding bytes of the destination register.

Restrictions

Do not use SP and do not use PC.

Condition flags

These instructions do not change the flags.

Examples

```

SADD16 R1, R0 ; Adds the halfwords in R0 to the corresponding
              ; halfwords of R1 and writes to corresponding halfword
              ; of R1.
SADD8  R4, R0, R5 ; Adds bytes of R0 to the corresponding byte in R5 and
                 ; writes to the corresponding byte in R4.

```

3.5.10 SHADD16 and SHADD8

Signed Halving Add 16 and Signed Halving Add 8.

Syntax

op{*cond*}{*Rd*,} *Rn*, *Rm*

Where:

<i>op</i>	Is one of: SHADD16 Signed Halving Add 16 SHADD8 Signed Halving Add 8
<i>cond</i>	Is an optional condition code. See Conditional execution on page 68 .
<i>Rd</i>	Is the destination register.
<i>Rn</i>	Is the first operand register.
<i>Rm</i>	Is the second operand register.

Operation

Use these instructions to add 16-bit and 8-bit data and then to halve the result before writing the result to the destination register.

The SHADD16 instruction:

1. Adds each halfword from the first operand to the corresponding halfword of the second operand.
2. Shuffles the result by one bit to the right, halving the data.
3. Writes the halfword results in the destination register.

The SHADD8 instruction:

1. Adds each byte of the first operand to the corresponding byte of the second operand.
2. Shuffles the result by one bit to the right, halving the data.
3. Writes the byte results in the destination register.

Restrictions

Do not use SP and do not use PC.

Condition flags

These instructions do not change the flags.

Examples

```
SHADD16 R1, R0      ; Adds halfwords in R0 to corresponding halfword of R1
                   ; and writes halved result to corresponding halfword in
                   ; R1.
SHADD8  R4, R0, R5 ; Adds bytes of R0 to corresponding byte in R5 and
                   ; writes halved result to corresponding byte in R4.
```

3.5.11 SHASX and SHSAX

Signed Halving Add and Subtract with Exchange and Signed Halving Subtract and Add with Exchange.

Syntax

```
op{cond} {Rd}, Rn, Rm
```

Where:

<i>op</i>	Is one of: SHASX Add and Subtract with Exchange and Halving. SHSAX Subtract and Add with Exchange and Halving.
<i>cond</i>	Is an optional condition code. See Conditional execution on page 68 .
<i>Rd</i>	Is the destination register.
<i>Rn, Rm</i>	Are registers holding the first and second operands.

Operation

The SHASX instruction:

1. Adds the top halfword of the first operand with the bottom halfword of the second operand.
2. Writes the halfword result of the addition to the top halfword of the destination register, shifted by one bit to the right causing a divide by two, or halving.
3. Subtracts the top halfword of the second operand from the bottom highword of the first operand.
4. Writes the halfword result of the division in the bottom halfword of the destination register, shifted by one bit to the right causing a divide by two, or halving.

The SHSAX instruction:

1. Subtracts the bottom halfword of the second operand from the top highword of the first operand.
2. Writes the halfword result of the addition to the bottom halfword of the destination register, shifted by one bit to the right causing a divide by two, or halving.
3. Adds the bottom halfword of the first operand with the top halfword of the second operand.
4. Writes the halfword result of the division in the top halfword of the destination register, shifted by one bit to the right causing a divide by two, or halving.

Restrictions

Do not use SP and do not use PC.

Condition flags

These instructions do not affect the condition code flags.

Examples

```
SHASX    R7, R4, R2    ; Adds top halfword of R4 to bottom halfword of
                    ; R2 and writes halved result to top halfword of
                    ; R7. Subtracts top halfword of R2 from bottom
```

```

; halfword of R4 and writes halved result to
; bottom halfword of R7.
SHSAX    R0, R3, R5
; Subtracts bottom halfword of R5 from top
; halfword of R3 and writes halved result to top
; halfword of R0.
; Adds top halfword of R5 to bottom halfword of
; R3 and writes halved result to bottom halfword
; of R0.

```

3.5.12 SHSUB16 and SHSUB8

Signed Halving Subtract 16 and Signed Halving Subtract 8.

Syntax

op{*cond*}{*Rd*,} *Rn*, *Rm*

Where:

op Is one of:

SHSUB16 Signed Halving Subtract 16.

SHSUB8 Signed Halving Subtract 8.

cond Is an optional condition code. See [Conditional execution on page 68](#).

Rd Is the destination register.

Rn Is the first operand register.

Rm Is the second operand register

Operation

Use these instructions to add 16-bit and 8-bit data and then to halve the result before writing the result to the destination register.

The SHSUB16 instruction:

1. Subtracts each halfword of the second operand from the corresponding halfwords of the first operand.
2. Shuffles the result by one bit to the right, halving the data.
3. Writes the halved halfword results in the destination register.

The SHSUB8 instruction:

1. Subtracts each byte of the second operand from the corresponding byte of the first operand.
2. Shuffles the result by one bit to the right, halving the data.
3. Writes the corresponding signed byte results in the destination register.

Restrictions

Do not use SP and do not use PC.

Condition flags

These instructions do not change the flags.

Examples

```
SHSUB16 R1, R0      ; Subtracts halfwords in R0 from corresponding
                    ; halfword of R1 and writes to corresponding halfword
                    ; of R1.
SHSUB8  R4, R0, R5  ; Subtracts bytes of R0 from corresponding byte in R5,
                    ; and writes to corresponding byte in R4.
```

3.5.13 SSUB16 and SSUB8

Signed Subtract 16 and Signed Subtract 8.

Syntax

```
op{cond}{Rd,} Rn, Rm
```

Where:

<i>op</i>	Is one of: SSUB16 Performs two 16-bit signed integer subtractions. SSUB8 Performs four 8-bit signed integer subtractions.
<i>cond</i>	Is an optional condition code. See Conditional execution on page 68 .
<i>Rd</i>	Is the destination register.
<i>Rn</i>	Is the first operand register.
<i>Rm</i>	Is the second operand register.

Operation

Use these instructions to change endianness of data.

The SSUB16 instruction:

1. Subtracts each halfword from the second operand from the corresponding halfword of the first operand.
2. Writes the difference result of two signed halfwords in the corresponding halfword of the destination register.

The SSUB8 instruction:

1. Subtracts each byte of the second operand from the corresponding byte of the first operand.
2. Writes the difference result of four signed bytes in the corresponding byte of the destination register.

Restrictions

Do not use SP and do not use PC.

Condition flags

These instructions do not change the flags.

Examples

```
SSUB16 R1, R0      ; Subtracts halfwords in R0 from corresponding
halfword of R1
```

```

; halfword of R1 and writes to corresponding halfword
; of R1.
SSUB8 R4, R0, R5 ; Subtracts bytes of R5 from corresponding byte in
; R0, and writes to corresponding byte of R4.

```

3.5.14 SASX and SSAX

Signed Add and Subtract with Exchange and Signed Subtract and Add with Exchange.

Syntax

```
op{cond} {Rd}, Rm, Rn
```

Where:

op Is one of:

SASX Signed Add and Subtract with Exchange.

SSAX Signed Subtract and Add with Exchange.

cond Is an optional condition code. See [Conditional execution on page 68](#).

Rd Is the destination register.

Rn, *Rm* Are registers holding the first and second operands.

Operation

The SASX instruction:

1. Adds the signed top halfword of the first operand with the signed bottom halfword of the second operand.
2. Writes the signed result of the addition to the top halfword of the destination register.
3. Subtracts the signed bottom halfword of the second operand from the top signed highword of the first operand.
4. Writes the signed result of the subtraction to the bottom halfword of the destination register.

The SSAX instruction:

1. Subtracts the signed bottom halfword of the second operand from the top signed highword of the first operand.
2. Writes the signed result of the addition to the bottom halfword of the destination register.
3. Adds the signed top halfword of the first operand with the signed bottom halfword of the second operand.
4. Writes the signed result of the subtraction to the top halfword of the destination register.

Restrictions

Do not use SP and do not use PC.

Condition flags

These instructions do not affect the condition code flags.

Examples

```
SASX R0, R4, R5 ; Adds top halfword of R4 to bottom halfword of R5
```

```

; and writes to top halfword of R0.
; Subtracts bottom halfword of R5 from top halfword
; of R4 and writes to bottom halfword of R0.
SSAX    R7, R3, R2 ; Subtracts top halfword of R2 from bottom halfword
; of R3 and writes to bottom halfword of R7.
; Adds top halfword of R3 with bottom halfword of R
; R2 and writes to top halfword of R7.

```

3.5.15 TST and TEQ

Test bits and Test Equivalence.

Syntax

TST{*cond*} *Rn*, *Operand2*

TEQ{*cond*} *Rn*, *Operand2*

Where:

cond Is an optional condition code. See [Conditional execution on page 68](#).

Rn Is the register holding the first operand.

Operand2 Is a flexible second operand. See [Flexible second operand on page 64](#) for details of the options.

Operation

These instructions test the value in a register against *Operand2*. They update the condition flags based on the result, but do not write the result to a register.

The TST instruction performs a bitwise AND operation on the value in *Rn* and the value of *Operand2*. This is the same as the ANDS instruction, except that it discards the result.

To test whether a bit of *Rn* is 0 or 1, use the TST instruction with an *Operand2* constant that has that bit set to 1 and all other bits cleared to 0.

The TEQ instruction performs a bitwise Exclusive OR operation on the value in *Rn* and the value of *Operand2*. This is the same as the EORS instruction, except that it discards the result.

Use the TEQ instruction to test if two values are equal without affecting the V or C flags.

TEQ is also useful for testing the sign of a value. After the comparison, the N flag is the logical Exclusive OR of the sign bits of the two operands.

Restrictions

Do not use SP and do not use PC.

Condition flags

These instructions:

- Update the N and Z flags according to the result.
- Can update the C flag during the calculation of *Operand2*, see [Flexible second operand on page 64](#).
- Do not affect the V flag.

Examples

```
TST    R0, #0x3F8 ; Perform bitwise AND of R0 value to 0x3F8,
                ; APSR is updated but result is discarded
TEQEQ  R10, R9   ; Conditionally test if value in R10 is equal to
                ; value in R9, APSR is updated but result is
                ; discarded.
```

3.5.16 UADD16 and UADD8

Unsigned Add 16 and Unsigned Add 8.

Syntax

op{*cond*}{*Rd*,} *Rn*, *Rm*

Where:

op Is one of:

UADD16 Performs two 16-bit unsigned integer additions.

UADD8 Performs four 8-bit unsigned integer additions.

cond Is an optional condition code. See [Conditional execution on page 68](#).

Rd Is the destination register.

Rn Is the first register holding the operand.

Rm Is the second register holding the operand.

Operation

Use these instructions to add 16- and 8-bit unsigned data.

The UADD16 instruction:

1. Adds each halfword from the first operand to the corresponding halfword of the second operand.
2. Writes the unsigned result in the corresponding halfwords of the destination register.

The UADD8 instruction:

1. Adds each byte of the first operand to the corresponding byte of the second operand.
2. Writes the unsigned result in the corresponding byte of the destination register.

Restrictions

Do not use SP and do not use PC.

Condition flags

These instructions do not change the flags.

Examples

```
UADD16 R1, R0   ; Adds halfwords in R0 to corresponding halfword of R1,
                ; writes to corresponding halfword of R1.
UADD8  R4, R0, R5 ; Adds bytes of R0 to corresponding byte in R5 and
                ; writes to corresponding byte in R4.
```

3.5.17 UASX and USAX

Add and Subtract with Exchange and Subtract and Add with Exchange.

Syntax

op{*cond*} {*Rd*}, *Rn*, *Rm*

Where:

<i>op</i>	Is one of:
	UASX Add and Subtract with Exchange.
	USAX Subtract and Add with Exchange.
<i>cond</i>	Is an optional condition code. See Conditional execution on page 68 .
<i>Rd</i>	Is the destination register.
<i>Rn</i> , <i>Rm</i>	Are registers holding the first and second operands.

Operation

The UASX instruction:

1. Subtracts the top halfword of the second operand from the bottom halfword of the first operand.
2. Writes the unsigned result from the subtraction to the bottom halfword of the destination register.
3. Adds the top halfword of the first operand with the bottom halfword of the second operand.
4. Writes the unsigned result of the addition to the top halfword of the destination register.

The USAX instruction:

1. Adds the bottom halfword of the first operand with the top halfword of the second operand.
2. Writes the unsigned result of the addition to the bottom halfword of the destination register.
3. Subtracts the bottom halfword of the second operand from the top halfword of the first operand.
4. Writes the unsigned result from the subtraction to the top halfword of the destination register.

Restrictions

Do not use SP and do not use PC.

Condition flags

These instructions do not affect the condition code flags.

Examples

```

UASX    R0, R4, R5    ; Adds top halfword of R4 to bottom halfword of R5
                        ; and writes to top halfword of R0.
                        ; Subtracts bottom halfword of R5 from top halfword
                        ; of R0 and writes to bottom halfword of R0.
USAX    R7, R3, R2    ; Subtracts top halfword of R2 from bottom halfword
                        ; of R3 and writes to bottom halfword of R7.
                        ; Adds top halfword of R3 to bottom halfword of R2

```

; and writes to top halfword of R7.

3.5.18 UHADD16 and UHADD8

Unsigned Halving Add 16 and Unsigned Halving Add 8.

Syntax

op{*cond*}{*Rd*,} *Rn*, *Rm*

Where:

<i>op</i>	Is one of: UHADD16 Unsigned Halving Add 16. UHADD8 Unsigned Halving Add 8.
<i>cond</i>	Is an optional condition code. See Conditional execution on page 68 .
<i>Rd</i>	Is the destination register.
<i>Rn</i>	Is the register holding the first operand.
<i>Rm</i>	Is the register holding the second operand.

Operation

Use these instructions to add 16- and 8-bit data and then to halve the result before writing the result to the destination register.

The UHADD16 instruction:

1. Adds each halfword from the first operand to the corresponding halfword of the second operand.
2. Shuffles the halfword result by one bit to the right, halving the data.
3. Writes the unsigned results to the corresponding halfword in the destination register.

The UHADD8 instruction:

1. Adds each byte of the first operand to the corresponding byte of the second operand.
2. Shuffles the byte result by one bit to the right, halving the data.
3. Writes the unsigned results in the corresponding byte in the destination register.

Restrictions

Do not use SP and do not use PC.

Condition flags

These instructions do not change the flags.

Examples

```
UHADD16 R7, R3      ; Adds halfwords in R7 to corresponding halfword of R3
                   ; and writes halved result to corresponding halfword
                   ; in R7.
UHADD8  R4, R0, R5  ; Adds bytes of R0 to corresponding byte in R5 and
                   ; writes halved result to corresponding byte in R4.
```

3.5.19 UHASX and UHSAX

Unsigned Halving Add and Subtract with Exchange and Unsigned Halving Subtract and Add with Exchange.

Syntax

`op{cond} {Rd}, Rn, Rm`

Where:

<code>op</code>	Is one of: UHASX Add and Subtract with Exchange and Halving. UHSAX Subtract and Add with Exchange and Halving.
<code>cond</code>	Is an optional condition code. See Conditional execution on page 68 .
<code>Rd</code>	Is the destination register.
<code>Rn, Rm</code>	Are registers holding the first and second operands.

Operation

The UHASX instruction:

1. Adds the top halfword of the first operand with the bottom halfword of the second operand.
2. Shifts the result by one bit to the right causing a divide by two, or halving.
3. Writes the halfword result of the addition to the top halfword of the destination register.
4. Subtracts the top halfword of the second operand from the bottom highword of the first operand.
5. Shifts the result by one bit to the right causing a divide by two, or halving.
6. Writes the halfword result of the division in the bottom halfword of the destination register.

The UHSAX instruction:

1. Subtracts the bottom halfword of the second operand from the top highword of the first operand.
2. Shifts the result by one bit to the right causing a divide by two, or halving.
3. Writes the halfword result of the subtraction in the top halfword of the destination register.
4. Adds the bottom halfword of the first operand with the top halfword of the second operand.
5. Shifts the result by one bit to the right causing a divide by two, or halving.
6. Writes the halfword result of the addition to the bottom halfword of the destination register.

Restrictions

Do not use SP and do not use PC.

Condition flags

These instructions do not affect the condition code flags.

Examples

`UHASX R7, R4, R2 ; Adds top halfword of R4 with bottom halfword of`

```

; R2 and writes halved result to top halfword of
; R7.
; Subtracts top halfword of R2 from bottom
; halfword of R7 and writes halved result to
; bottom halfword of R7.
UHSAX    R0, R3, R5 ; Subtracts bottom halfword of R5 from top
; halfword of R3 and writes halved result to top
; halfword of R0.
; Adds top halfword of R5 to bottom halfword of R3
; and writes halved result to bottom halfword of
; R0.

```

3.5.20 UHSUB16 and UHSUB8

Unsigned Halving Subtract 16 and Unsigned Halving Subtract 8.

Syntax

op{*cond*}{*Rd*,} *Rn*, *Rm*

Where:

<i>op</i>	Is one of:
UHSUB16	Performs two unsigned 16-bit integer additions, halves the results, and writes the results to the destination register.
UHSUB8	Performs four unsigned 8-bit integer additions, halves the results, and writes the results to the destination register.
<i>cond</i>	Is an optional condition code. See Conditional execution on page 68 .
<i>Rd</i>	Is the destination register.
<i>Rn</i>	Is the first register holding the operand.
<i>Rm</i>	Is the second register holding the operand.

Operation

Use these instructions to add 16-bit and 8-bit data and then to halve the result before writing the result to the destination register.

The UHSUB16 instruction:

1. Subtracts each halfword of the second operand from the corresponding halfword of the first operand.
2. Shuffles each halfword result to the right by one bit, halving the data.
3. Writes each unsigned halfword result to the corresponding halfwords in the destination register.

The UHSUB8 instruction:

1. Subtracts each byte of second operand from the corresponding byte of the first operand.
2. Shuffles each byte result by one bit to the right, halving the data.
3. Writes the unsigned byte results to the corresponding byte of the destination register.

Restrictions

Do not use SP and do not use PC.

Condition flags

These instructions do not change the flags.

Examples

```
UHSUB16 R1, R0      ; Subtracts halfwords in R0 from corresponding
                    ; halfword of R1 and writes halved result to
                    ; corresponding halfword in R1.
UHSUB8  R4, R0, R5  ; Subtracts bytes of R5 from corresponding byte in R0
                    ; and writes halved result to corresponding byte in
                    ; R4.
```

3.5.21 SEL

Select Bytes. Selects each byte of its result from either its first operand or its second operand, according to the values of the GE flags.

Syntax

```
SEL{<c>}{<q>} {<Rd>}, <Rn>, <Rm>
```

Where:

<c>, <q> Is a standard assembler syntax field.
 <Rd> Is the destination register.
 <Rn> Is the first operand register.
 <Rm> Is the second operand register.

Operation

The SEL instruction:

1. Reads the value of each bit of APSR.GE.
2. Depending on the value of APSR.GE, assigns the destination register the value of either the first or second operand register.

Restrictions

None.

Condition flags

These instructions do not change the flags.

Examples

```
SADD16 R0, R1, R2    ; Set GE bits based on result.
SEL R0, R0, R3       ; Select bytes from R0 or R3, based on GE.
```

3.5.22 USAD8

Unsigned Sum of Absolute Differences.

Syntax

```
USAD8{cond}{Rd}, Rn, Rm
```

Where:

<i>cond</i>	Is an optional condition code. See Conditional execution on page 68 .
<i>Rd</i>	Is the destination register.
<i>Rn</i>	Is the first operand register.
<i>Rm</i>	Is the second operand register.

Operation

The USAD8 instruction:

- Subtracts each byte of the second operand register from the corresponding byte of the first operand register.
- Adds the absolute values of the differences together.
- Writes the result to the destination register.

Restrictions

Do not use SP and do not use PC.

Condition flags

These instructions do not change the flags.

Examples

```
USAD8 R1, R4, R0      ; Subtracts each byte in R0 from corresponding byte
                       ; of R4 adds the differences and writes to R1.
USAD8 R0, R5          ; Subtracts bytes of R5 from corresponding byte in
                       ; R0, adds the differences and writes to R0.
```

3.5.23 USADA8

Unsigned Sum of Absolute Differences and Accumulate.

Syntax

```
USADA8{cond}{Rd,} Rn, Rm, Ra
```

Where:

<i>cond</i>	Is an optional condition code. See Conditional execution on page 68 .
<i>Rd</i>	Is the destination register.
<i>Rn</i>	Is the first operand register.
<i>Rm</i>	Is the second operand register.
<i>Ra</i>	Is the register that contains the accumulation value.

Operation

The USADA8 instruction:

1. Subtracts each byte of the second operand register from the corresponding byte of the first operand register.
2. Adds the unsigned absolute differences together.
3. Adds the accumulation value to the sum of the absolute differences.
4. Writes the result to the destination register.

Restrictions

Do not use SP and do not use PC.

Condition flags

These instructions do not change the flags.

Examples

```
USADA8 R1, R0, R6      ; Subtracts bytes in R0 from corresponding halfword
                       ; of R1 adds differences, adds value of R6, writes
                       ; to R1.
USADA8 R4, R0, R5, R2 ; Subtracts bytes of R5 from corresponding byte in
                       ; R0 adds differences, adds value of R2 writes to
                       ; R4.
```

3.5.24 USUB16 and USUB8

Unsigned Subtract 16 and Unsigned Subtract 8.

Syntax

```
op{cond}{Rd,} Rn, Rm
```

Where:

<i>op</i>	Is one of: USUB16 Unsigned Subtract 16. USUB8 Unsigned Subtract 8.
<i>cond</i>	Is an optional condition code. See Conditional execution on page 68 .
<i>Rd</i>	Is the destination register.
<i>Rn</i>	Is the first operand register.
<i>Rm</i>	Is the second operand register.

Operation

Use these instructions to subtract 16-bit and 8-bit data before writing the result to the destination register.

The USUB16 instruction:

1. Subtracts each halfword from the second operand register from the corresponding halfword of the first operand register.
2. Writes the unsigned result in the corresponding halfwords of the destination register.

The USUB8 instruction:

1. Subtracts each byte of the second operand register from the corresponding byte of the first operand register.
2. Writes the unsigned byte result in the corresponding byte of the destination register.

Restrictions

Do not use SP and do not use PC.

Condition flags

These instructions do not change the flags.

Examples

```
USUB16 R1, R0      ; Subtracts halfwords in R0 from corresponding halfword
                   ; of R1 and writes to corresponding halfword in R1.
USUB8  R4, R0, R5  ; Subtracts bytes of R5 from corresponding byte in R0
                   ; and writes to the corresponding byte in R4.
```

3.6 Multiply and divide instructions

[Table 31](#) shows the multiply and divide instructions:

Table 31. Multiply and divide instructions

Mnemonic	Brief description	See
MLA	Multiply with Accumulate, 32-bit result	MUL, MLA, and MLS on page 112
MLS	Multiply and Subtract, 32-bit result	MUL, MLA, and MLS on page 112
MUL	Multiply, 32-bit result	MUL, MLA, and MLS on page 112
SDIV	Signed Divide	SDIV and UDIV on page 127
SMLA[B,T]	Signed Multiply Accumulate (halfwords)	SMMLA and SMMLS on page 121
SMLAD, SMLADX	Signed Multiply Accumulate Dual	SMLAD on page 116
SMLAL	Signed Multiply with Accumulate (32x32+64), 64-bit result	UMULL, UMLAL, SMULL, and SMLAL on page 126
SMLAL[B,T]	Signed Multiply Accumulate Long (halfwords)	SMLAL and SMLALD on page 117
SMLALD, SMLALDX	Signed Multiply Accumulate Long Dual	SMLAL and SMLALD on page 117
SMLAW[B T]	Signed Multiply Accumulate (word by halfword)	SMLA and SMLAW on page 115
SMLSD	Signed Multiply Subtract Dual	SMLSD and SMLS�D on page 119
SMLS�D	Signed Multiply Subtract Long Dual	SMLSD and SMLS�D on page 119
SMMLA	Signed Most Significant Word Multiply Accumulate	SMMLA and SMMLS on page 121
SMMLS, SMMLSR	Signed Most Significant Word Multiply Subtract	SMMLA and SMMLS on page 121

Table 31. Multiply and divide instructions (continued)

Mnemonic	Brief description	See
SMUAD, SMUADX	Signed Dual Multiply Add	SMUAD and SMUSD on page 123
SMUL[B,T]	Signed Multiply (word by halfword)	SMUL and SMULW on page 124
SMMUL, SMMULR	Signed Most Significant Word Multiply	SMMUL on page 122
SMULL	Signed Multiply (32x32), 64-bit result	UMULL, UMLAL, SMULL, and SMLAL on page 126
SMULWB, SMULWT	Signed Multiply (word by halfword)	SMUL and SMULW on page 124
SMUSD, SMUSDX	Signed Dual Multiply Subtract	SMUAD and SMUSD on page 123
UDIV	Unsigned Divide	SDIV and UDIV on page 127
UMAAL	Unsigned Multiply Accumulate Accumulate Long (32x32+32+32), 64-bit result	UMULL, UMAAL, UMLAL on page 113
UMLAL	Unsigned Multiply with Accumulate (32x32+64), 64-bit result	UMULL, UMAAL, UMLAL on page 113
UMULL	Unsigned Multiply (32x32), 64-bit result	UMULL, UMAAL, UMLAL on page 113

3.6.1 MUL, MLA, and MLS

Multiply, Multiply with Accumulate, and Multiply with Subtract, using 32-bit operands, and producing a 32-bit result.

Syntax

```
MUL{S}{cond} {Rd,} Rn, Rm ; Multiply
MLA{cond} Rd, Rn, Rm, Ra ; Multiply with accumulate
MLS{cond} Rd, Rn, Rm, Ra ; Multiply with subtract
```

Where:

- cond* Is an optional condition code. See [Conditional execution on page 68](#).
- S* Is an optional suffix. If *s* is specified, the condition code flags are updated on the result of the operation, see [Conditional execution on page 68](#).
- Rd* Is the destination register. If *Rd* is omitted, the destination register is *Rn*.
- Rn, Rm* Are registers holding the values to be multiplied.
- Ra* Is a register holding the value to be added or subtracted from.

Operation

The MUL instruction multiplies the values from *Rn* and *Rm*, and places the least significant 32 bits of the result in *Rd*.

The MLA instruction multiplies the values from *Rn* and *Rm*, adds the value from *Ra*, and places the least significant 32 bits of the result in *Rd*.

The MLS instruction multiplies the values from *Rn* and *Rm*, subtracts the product from the value from *Ra*, and places the least significant 32 bits of the result in *Rd*.

The results of these instructions do not depend on whether the operands are signed or unsigned.

Restrictions

In these instructions, do not use SP and do not use PC.

If the S suffix is used with the MUL instruction:

- *Rd*, *Rn*, and *Rm* must all be in the range R0 to R7.
- *Rd* must be the same as *Rm*.
- The *cond* suffix must not be used.

Condition flags

If S is specified, the MUL instruction:

- Updates the N and Z flags according to the result.
- Does not affect the C and V flags.

Examples

```
MUL    R10, R2, R5      ; Multiply, R10 = R2 x R5
MLA    R10, R2, R1, R5  ; Multiply with accumulate, R10 = (R2 x R1) +
                        ; R5
MULS   R0, R2, R2       ; Multiply with flag update, R0 = R2 x R2
MULLT  R2, R3, R2       ; Conditionally multiply, R2 = R3 x R2
MLS    R4, R5, R6, R7   ; Multiply with subtract, R4 = R7 - (R5 x R6)
```

3.6.2 UMULL, UMAAL, UMLAL

Unsigned Long Multiply, with optional Accumulate, using 32-bit operands and producing a 64-bit result.

Syntax

op{*cond*} *RdLo*, *RdHi*, *Rn*, *Rm*

Where:

op Is one of:

- UMULL Unsigned Long Multiply.
- UMAAL Unsigned Long Multiply with Accumulate Accumulate.
- UMLAL Unsigned Long Multiply, with Accumulate.

cond Is an optional condition code. See [Conditional execution on page 68](#).

RdHi, *RdLo* Are the destination registers. For UMAAL, UMLAL and UMLAL they also hold the accumulating value.

Rn, *Rm* Are registers holding the first and second operands.

Operation

These instructions interpret the values from *Rn* and *Rm* as unsigned 32-bit integers.

The UMULL instruction:

- Multiplies the two unsigned integers in the first and second operands.
- Writes the least significant 32 bits of the result in *RdLo*.
- Writes the most significant 32 bits of the result in *RdHi*.

The UMAAL instruction:

- Multiplies the two unsigned 32-bit integers in the first and second operands.
- Adds the unsigned 32-bit integer in *RdHi* to the 64-bit result of the multiplication.
- Adds the unsigned 32-bit integer in *RdLo* to the 64-bit result of the addition.
- Writes the top 32-bits of the result to *RdHi*.
- Writes the lower 32-bits of the result to *RdLo*.

The UMLAL instruction:

- Multiplies the two unsigned integers in the first and second operands.
- Adds the 64-bit result to the 64-bit unsigned integer contained in *RdHi* and *RdLo*.
- Writes the result back to *RdHi* and *RdLo*.

Restrictions

In these instructions:

- Do not use SP and do not use PC.
- *RdHi* and *RdLo* must be different registers.

Condition flags

These instructions do not affect the condition code flags.

Examples

```

UMULL   R0, R4, R5, R6   ; Multiplies R5 and R6, writes the top 32 bits to
                        ; R4 and the bottom 32 bits to R0.
UMAAL   R3, R6, R2, R7   ; Multiplies R2 and R7, adds R6, adds R3, writes
                        ; the top 32 bits to R6, and the bottom 32 bits
                        ; to R3.
UMLAL   R2, R1, R3, R5   ; Multiplies R5 and R3, adds R1:R2, writes to
                        ; R1:R2.

```

3.6.3 SMLA and SMLAW

Signed Multiply Accumulate (halfwords).

Syntax

$op\{XY\}\{cond\} Rd, Rn, Rm$

$op\{Y\}\{cond\} Rd, Rn, Rm, Ra$

Where:

op Is one of:

SMLA Signed Multiply Accumulate Long (halfwords)

X and Y specifies which half of the source registers Rn and Rm are used as the first and second multiply operand.

If X is B , then the bottom halfword, bits [15:0], of Rn is used.

If X is T , then the top halfword, bits [31:16], of Rn is used.

If Y is B , then the bottom halfword, bits [15:0], of Rm is used.

If Y is T , then the top halfword, bits [31:16], of Rm is used.

SMLAW Signed Multiply Accumulate (word by halfword)

Y specifies which half of the source register Rm is used as the second multiply operand.

If Y is T , then the top halfword, bits [31:16] of Rm is used.

If Y is B , then the bottom halfword, bits [15:0] of Rm is used.

$cond$ Is an optional condition code. See [Conditional execution on page 68](#).

Rd Is the destination register. If Rd is omitted, the destination register is Rn .

Rn, Rm Are registers holding the values to be multiplied.

Ra Is a register holding the value to be added or subtracted from.

Operation

The SMALBB, SMLABT, SMLATB, SMLATT instructions:

- Multiplies the specified signed halfword, top or bottom, values from Rn and Rm .
- Adds the value in Ra to the resulting 32-bit product.
- Writes the result of the multiplication and addition in Rd .

The non-specified halfwords of the source registers are ignored.

The SMLAWB and SMLAWT instructions:

- Multiply the 32-bit signed values in Rn with:
 - The top signed halfword of Rm , T instruction suffix.
 - The bottom signed halfword of Rm , B instruction suffix.
- Add the 32-bit signed value in Ra to the top 32 bits of the 48-bit product
- Writes the result of the multiplication and addition in Rd .

The bottom 16 bits of the 48-bit product are ignored.

If overflow occurs during the addition of the accumulate value, the instruction sets the Q flag in the APSR. No overflow can occur during the multiplication.

Restrictions

In these instructions, do not use SP and do not use PC.

Condition flags

If an overflow is detected, the Q flag is set.

Examples

```

SMLABB R5, R6, R4, R1 ; Multiplies bottom halfwords of R6 and R4, adds
                        ; R1 and writes to R5.
SMLATB R5, R6, R4, R1 ; Multiplies top halfword of R6 with bottom
                        ; halfword of R4, adds R1 and writes to R5.
SMLATT R5, R6, R4, R1 ; Multiplies top halfwords of R6 and R4, adds
                        ; R1 and writes the sum to R5.
SMLABT R5, R6, R4, R1 ; Multiplies bottom halfword of R6 with top
                        ; halfword of R4, adds R1 and writes to R5.
SMLABT R4, R3, R2      ; Multiplies bottom halfword of R4 with top
                        ; halfword of R3, adds R2 and writes to R4.
SMLAWB R10, R2, R5, R3 ; Multiplies R2 with bottom halfword of R5, adds
                        ; R3 to the result and writes top 32-bits to R10.
SMLAWT R10, R2, R1, R5 ; Multiplies R2 with top halfword of R1, adds R5
                        ; and writes top 32-bits to R10.

```

3.6.4 SMLAD

Signed Multiply Accumulate Long Dual.

Syntax

`op{X}{cond} Rd, Rn, Rm, Ra`

Where:

<code>op</code>	Is one of: SMLAD Signed Multiply Accumulate Dual. SMLADX Signed Multiply Accumulate Dual Reverse. <i>X</i> specifies which halfword of the source register <i>Rn</i> is used as the multiply operand. If <i>X</i> is omitted, the multiplications are bottom × bottom and top × top. If <i>X</i> is present, the multiplications are bottom × top and top × bottom.
<code>cond</code>	Is an optional condition code. See Conditional execution on page 68 .
<code>Rd</code>	Is the destination register.
<code>Rn</code>	Is the first operand register holding the values to be multiplied.
<code>Rm</code>	Is the second operand register.
<code>Ra</code>	Is the accumulate value.

Operation

The SMLAD and SMLADX instructions regard the two operands as four halfword 16-bit values. The SMLAD and SMLADX instructions:

- If *X* is not present, multiply the top signed halfword value in *Rn* with the top signed halfword of *Rm* and the bottom signed halfword values in *Rn* with the bottom signed halfword of *Rm*.
- Or if *X* is present, multiply the top signed halfword value in *Rn* with the bottom signed halfword of *Rm* and the bottom signed halfword values in *Rn* with the top signed halfword of *Rm*.
- Add both multiplication results to the signed 32-bit value in *Ra*.
- Writes the 32-bit signed result of the multiplication and addition to *Rd*.

Restrictions

Do not use SP and do not use PC.

Condition flags

These instructions do not change the flags.

Examples

```
SMLAD   R10, R2, R1, R5 ; Multiplies two halfword values in R2 with
                        ; corresponding halfwords in R1, adds R5 and
                        ; writes to R10.
```

```
SMLALDX R0, R2, R4, R6 ; Multiplies top halfword of R2 with bottom
                        ; halfword of R4, multiplies bottom halfword of R2
                        ; with top halfword of R4, adds R6 and writes to
                        ; R0.
```

3.6.5 SMLAL and SMLALD

Signed Multiply Accumulate Long, Signed Multiply Accumulate Long (halfwords) and Signed Multiply Accumulate Long Dual.

Syntax

```
op{cond} RdLo, RdHi, Rn, Rm
```

```
op{XY}{cond} RdLo, RdHi, Rn, Rm
```

```
op{X}{cond} RdLo, RdHi, Rn, Rm
```

Where:

op Is one of:

SMLAL Signed Multiply Accumulate Long.

SMLALXY Signed Multiply Accumulate Long (halfwords, X and Y).

X and Y specify which halfword of the source registers *Rn* and *Rm* are used as the first and second multiply operand:

If *X* is B, then the bottom halfword, bits [15:0], of *Rn* is used.

If *X* is T, then the top halfword, bits [31:16], of *Rn* is used.

If *Y* is B, then the bottom halfword, bits [15:0], of *Rm* is used.

If *Y* is T, then the top halfword, bits [31:16], of *Rm* is used.

- SMLALD** Signed Multiply Accumulate Long Dual.
- SMLALDX** Signed Multiply Accumulate Long Dual Reversed.
 If the *x* is omitted, the multiplications are bottom × bottom and top × top.
 If *x* is present, the multiplications are bottom × top and top × bottom.
- cond* Is an optional condition code. See [Conditional execution on page 68](#).
- RdHi*, *RdLo* Are the destination registers.
RdLo is the lower 32 bits and *RdHi* is the upper 32 bits of the 64-bit integer.
 For SMLAL, SMLALBB, SMLALBT, SMLALTB, SMLALTT, SMLALD and SMLALDX, they also hold the accumulating value.
- Rn*, *Rm* Are registers holding the first and second operands.

Operation

The SMLAL instruction:

- Multiplies the two's complement signed word values from *Rn* and *Rm*.
- Adds the 64-bit value in *RdLo* and *RdHi* to the resulting 64-bit product.
- Writes the 64-bit result of the multiplication and addition in *RdLo* and *RdHi*.

The SMLALBB, SMLALBT, SMLALTB and SMLALTT instructions:

- Multiplies the specified signed halfword, Top or Bottom, values from *Rn* and *Rm*.
- Adds the resulting sign-extended 32-bit product to the 64-bit value in *RdLo* and *RdHi*.
- Writes the 64-bit result of the multiplication and addition in *RdLo* and *RdHi*.

The non-specified halfwords of the source registers are ignored.

The SMLALD and SMLALDX instructions interpret the values from *Rn* and *Rm* as four halfword two's complement signed 16-bit integers. These instructions:

- If *X* is not present, multiply the top signed halfword value of *Rn* with the top signed halfword of *Rm* and the bottom signed halfword values of *Rn* with the bottom signed halfword of *Rm*.
- Or if *X* is present, multiply the top signed halfword value of *Rn* with the bottom signed halfword of *Rm* and the bottom signed halfword values of *Rn* with the top signed halfword of *Rm*.
- Add the two multiplication results to the signed 64-bit value in *RdLo* and *RdHi* to create the resulting 64-bit product.
- Write the 64-bit product in *RdLo* and *RdHi*.

Restrictions

In these instructions:

- Do not use SP and do not use PC.
- *RdHi* and *RdLo* must be different registers.

Condition flags

These instructions do not affect the condition code flags.

Examples

```
SMLAL      R4, R5, R3, R8 ; Multiplies R3 and R8, adds R5:R4 and writes
```

			; to R5:R4.
SMLALBT	R2, R1, R6, R7		; Multiplies bottom halfword of R6 with top ; halfword of R7, sign extends to 32-bit, ; adds R1:R2 and writes to R1:R2.
SMLALTB	R2, R1, R6, R7		; Multiplies top halfword of R6 with bottom ; halfword of R7, sign extends to 32-bit, adds ; R1:R2 and writes to R1:R2.
SMLALD	R6, R8, R5, R1		; Multiplies top halfwords in R5 and R1 and b ; bottom halfwords of R5 and R1, adds R8:R6 ; and writes to R8:R6.
SMLALDX	R6, R8, R5, R1		; Multiplies top halfword in R5 with bottom ; halfword of R1, and bottom halfword of R5 ; with top halfword of R1, adds R8:R6 and ; writes to R8:R6.

3.6.6 SMLSD and SMLSLD

Signed Multiply Subtract Dual and Signed Multiply Subtract Long Dual.

Syntax

op{*X*}{*cond*} *Rd*, *Rn*, *Rm*, *Ra*

Where:

op Is one of:

- SMLSD Signed Multiply Subtract Dual.
- SMLSDX Signed Multiply Subtract Dual Reversed.
- SMLSLD Signed Multiply Subtract Long Dual.
- SMLSLDX Signed Multiply Subtract Long Dual Reversed.

If *X* is present, the multiplications are bottom × top and top × bottom.

If the *X* is omitted, the multiplications are bottom × bottom and top × top.

cond Is an optional condition code. See [Conditional execution on page 68](#).

Rd Is the destination register.

Rn, *Rm* Are registers holding the first and second operands.

Ra Is the register holding the accumulate value.

Operation

The SMLSD instruction interprets the values from the first and second operands as four signed halfwords. This instruction:

- Optionally rotates the halfwords of the second operand.
- Performs two signed 16 × 16-bit halfword multiplications.
- Subtracts the result of the upper halfword multiplication from the result of the lower halfword multiplication.
- Adds the signed accumulate value to the result of the subtraction.
- Writes the result of the addition to the destination register.

The SMLSXD instruction interprets the values from *Rn* and *Rm* as four signed halfwords. This instruction:

- Optionally rotates the halfwords of the second operand.
- Performs two signed 16 × 16-bit halfword multiplications.
- Subtracts the result of the upper halfword multiplication from the result of the lower halfword multiplication.
- Adds the 64-bit value in *RdHi* and *RdLo* to the result of the subtraction.
- Writes the 64-bit result of the addition to the *RdHi* and *RdLo*.

Restrictions

In these instructions:

- Do not use SP and do not use PC.

Condition flags

This instruction sets the Q flag if the accumulate operation overflows. Overflow cannot occur during the multiplications or subtraction.

For the Thumb instruction set, these instructions do not affect the condition code flags.

Examples

```

SMLSXD      R0, R4, R5, R6    ; Multiplies bottom halfword of R4 with
                               ; bottom halfword of R5, multiplies top
                               ; halfword of R4 with top halfword of R5, sub
                               ; subtracts second from first, adds R6,
                               ; writes to R0.
SMLSXD      R1, R3, R2, R0    ; Multiplies bottom halfword of R3 with top
                               ; halfword of R2, multiplies top halfword of
                               ; R3 with bottom halfword of R2, subtracts se
                               ; second from first, adds R0, writes to R1.
SMLSXD      R3, R6, R2, R7    ; Multiplies bottom halfword of R6 with
                               ; bottom halfword of R2, multiplies top
                               ; halfword of R6 with top halfword of R2, sub
                               ; subtracts second first, adds R6:R3, writes
                               ; to R6:R3.
SMLSXD      R3, R6, R2, R7    ; Multiplies bottom halfword of R6 with top
                               ; halfword of R2, multiplies top halfword of
                               ; R6 with bottom halfword of R2, subtracts
                               ; second from first, adds R6:R3, writes to
                               ; R6:R3.

```

3.6.7 SMMLA and SMMLS

Signed Most Significant Word Multiply Accumulate and Signed Most Significant Word Multiply Subtract.

Syntax

$op\{R\}\{cond\} Rd, Rn, Rm, Ra$

Where:

op	Is one of: SMMLA Signed Most Significant Word Multiply Accumulate. SMMLS Signed Most Significant Word Multiply Subtract.
R	Is a rounding error flag. If R is specified, the result is rounded instead of being truncated. In this case the constant $0x80000000$ is added to the product before the high word is extracted.
$cond$	Is an optional condition code. See Conditional execution on page 68 .
Rd	Is the destination register.
Rn, Rm	Are registers holding the first and second multiply operands.
Ra	Is the register holding the accumulate value.

Operation

The SMMLA instruction interprets the values from Rn and Rm as signed 32-bit words.

The SMMLA instruction:

- Multiplies the values in Rn and Rm .
- Optionally rounds the result by adding $0x80000000$.
- Extracts the most significant 32 bits of the result.
- Adds the value of Ra to the signed extracted value.
- Writes the result of the addition in Rd .

The SMMLS instruction interprets the values from Rn and Rm as signed 32-bit words.

The SMMLS instruction:

- Multiplies the values in Rn and Rm .
- Optionally rounds the result by adding $0x80000000$.
- Extracts the most significant 32 bits of the result.
- Subtracts the extracted value of the result from the value in Ra .
- Writes the result of the subtraction in Rd .

Restrictions

In these instructions:

- Do not use SP and do not use PC.

Condition flags

These instructions do not affect the condition code flags.

Examples

```

SMMLA      R0, R4, R5, R6      ; Multiplies R4 and R5, extracts top 32 bits,
                                ; adds R6, truncates and writes to R0.
SMMLAR     R6, R2, R1, R4      ; Multiplies R2 and R1, extracts top 32 bits,
                                ; adds R4, rounds and writes to R6.
SMMLSR     R3, R6, R2, R7      ; Multiplies R6 and R2, extracts top 32 bits,
                                ; subtracts R7, rounds and writes to R3.
SMMLS      R4, R5, R3, R8      ; Multiplies R5 and R3, extracts top 32 bits,
                                ; subtracts R8, truncates and writes to R4.

```

3.6.8 SMMUL

Signed Most Significant Word Multiply.

Syntax

```
op{R}{cond} Rd, Rn, Rm
```

Where:

op Is one of:
SMMUL Signed Most Significant Word Multiply

R Is a rounding error flag. If *R* is specified, the result is rounded instead of being truncated. In this case the constant `0x80000000` is added to the product before the high word is extracted.

cond Is an optional condition code. See [Conditional execution on page 68](#).

Rd Is the destination register.

Rn, Rm Are registers holding the first and second operands.

Operation

The SMMUL instruction interprets the values from *Rn* and *Rm* as two's complement 32-bit signed integers. The SMMUL instruction:

- Multiplies the values from *Rn* and *Rm*.
- Optionally rounds the result, otherwise truncates the result.
- Writes the most significant signed 32 bits of the result in *Rd*.

Restrictions

In this instruction:

- Do not use SP and do not use PC.

Condition flags

This instruction does not affect the condition code flags.

Examples

```

SMULL      R0, R4, R5          ; Multiplies R4 and R5, truncates top 32 bits
                                ; and writes to R0.
SMULLR     R6, R2              ; Multiplies R6 and R2, rounds the top 32
                                ; bits and writes to R6.

```

3.6.9 SMUAD and SMUSD

Signed Dual Multiply Add and Signed Dual Multiply Subtract.

Syntax

$op\{X\}\{cond\} Rd, Rn, Rm$

Where:

op Is one of:

- SMUAD Signed Dual Multiply Add.
- SMUADX Signed Dual Multiply Add Reversed.
- SMUSD Signed Dual Multiply Subtract.
- SMUSDX Signed Dual Multiply Subtract Reversed.

If *x* is present, the multiplications are bottom × top and top × bottom.

If the *x* is omitted, the multiplications are bottom × bottom and top × top.

cond Is an optional condition code. See [Conditional execution on page 68](#).

Rd Is the destination register.

Rn, Rm Are registers holding the first and the second operands.

Operation

The SMUAD instruction interprets the values from the first and second operands as two signed halfwords in each operand. This instruction:

- Optionally rotates the halfwords of the second operand.
- Performs two signed 16 × 16-bit multiplications.
- Adds the two multiplication results together.
- Writes the result of the addition to the destination register.

The SMUSD instruction interprets the values from the first and second operands as two's complement signed integers. This instruction:

- Optionally rotates the halfwords of the second operand.
- Performs two signed 16 × 16-bit multiplications.
- Subtracts the result of the top halfword multiplication from the result of the bottom halfword multiplication.
- Writes the result of the subtraction to the destination register.

Restrictions

In these instructions:

- Do not use SP and do not use PC.

Condition flags

Sets the Q flag if the addition overflows. The multiplications cannot overflow.

Examples

```
SMUAD    R0, R4, R5    ; Multiplies bottom halfword of R4 with the
                    ; bottom halfword of R5, adds multiplication of
```

			; top halfword of R4 with top halfword of R5, ; writes to R0.
SMUADX	R3, R7, R4		; Multiplies bottom halfword of R7 with top ; halfword of R4, adds multiplication of top ; halfword of R7 with bottom halfword of R4, ; writes to R3.
SMUSD	R3, R6, R2		; Multiplies bottom halfword of R4 with bottom ; halfword of R6, subtracts multiplication of top ; halfword of R6 with top halfword of R3, writes ; to R3.
SMUSDX	R4, R5, R3		; Multiplies bottom halfword of R5 with top ; halfword of R3, subtracts multiplication of top ; halfword of R5 with bottom halfword of R3, ; writes to R4.

3.6.10 SMUL and SMULW

Signed Multiply (halfwords) and Signed Multiply (word by halfword).

Syntax

op{*XY*}{*cond*} *Rd*, *Rn*, *Rm*

op{*Y*}{*cond*} *Rd*, *Rn*, *Rm*

For *SMULXY* only:

op Is one of:

SMUL{*XY*} Signed Multiply (halfwords)

X and *Y* specify which halfword of the source registers *Rn* and *Rm* is used as the first and second multiply operand.

If *X* is **B**, then the bottom halfword, bits [15:0] of *Rn* is used.

If *X* is **T**, then the top halfword, bits [31:16] of *Rn* is used. If *Y* is **B**, then the bottom halfword, bits [15:0], of *Rm* is used.

If *Y* is **T**, then the top halfword, bits [31:16], of *Rm* is used.

SMULW{*Y*} Signed Multiply (word by halfword)

Y specifies which halfword of the source register *Rm* is used as the second multiply operand.

If *Y* is **B**, then the bottom halfword (bits [15:0]) of *Rm* is used.

If *Y* is **T**, then the top halfword (bits [31:16]) of *Rm* is used.

cond Is an optional condition code. See [Conditional execution on page 68](#).

Rd Is the destination register.

Rn, *Rm* Are registers holding the first and second operands.

Operation

The SMULBB, SMULTB, SMULBT and SMULTT instructions interprets the values from *Rn* and *Rm* as four signed 16-bit integers.

These instructions:

- Multiply the specified signed halfword, Top or Bottom, values from *Rn* and *Rm*.
- Write the 32-bit result of the multiplication in *Rd*.

The SMULWT and SMULWB instructions interprets the values from *Rn* as a 32-bit signed integer and *Rm* as two halfword 16-bit signed integers. These instructions:

- Multiply the first operand and the top, T suffix, or the bottom, B suffix, halfword of the second operand.
- Write the signed most significant 32 bits of the 48-bit result in the destination register.

Restrictions

In these instructions:

- Do not use SP and do not use PC.
- *RdHi* and *RdLo* must be different registers.

Examples

SMULBT	R0, R4, R5	; Multiplies the bottom halfword of R4 with ; the top halfword of R5, multiplies results ; and writes to R0.
SMULBB	R0, R4, R5	; Multiplies the bottom halfword of R4 with ; the bottom halfword of R5, multiplies ; results and writes to R0.
SMULTT	R0, R4, R5	; Multiplies the top halfword of R4 with the ; top halfword of R5, multiplies results and ; writes to R0.
SMULTB	R0, R4, R5	; Multiplies the top halfword of R4 with the ; bottom halfword of R5, multiplies results ; and writes to R0.
SMULWT	R4, R5, R3	; Multiplies R5 with the top halfword of R3, ; extracts top 32 bits and writes to R4.
SMULWB	R4, R5, R3	; Multiplies R5 with the bottom halfword of ; R3, extracts top 32 bits and writes to R4.

3.6.11 UMULL, UMLAL, SMULL, and SMLAL

Signed and Unsigned Long Multiply, with optional Accumulate, using 32-bit operands and producing a 64-bit result.

Syntax

op{*cond*} *RdLo*, *RdHi*, *Rn*, *Rm*

Where:

op Is one of:

UMULL	Unsigned Long Multiply.
UMLAL	Unsigned Long Multiply, with Accumulate.
SMULL	Signed Long Multiply.
SMLAL	Signed Long Multiply, with Accumulate.

cond Is an optional condition code. See [Conditional execution on page 68](#).

RdHi, *RdLo* Are the destination registers. For UMLAL and SMLAL they also hold the accumulating value.

Rn, *Rm* Are registers holding the operands.

Operation

The UMULL instruction interprets the values from *Rn* and *Rm* as unsigned integers. It multiplies these integers and places the least significant 32 bits of the result in *RdLo*, and the most significant 32 bits of the result in *RdHi*.

The UMLAL instruction interprets the values from *Rn* and *Rm* as unsigned integers. It multiplies these integers, adds the 64-bit result to the 64-bit unsigned integer contained in *RdHi* and *RdLo*, and writes the result back to *RdHi* and *RdLo*.

The SMULL instruction interprets the values from *Rn* and *Rm* as two's complement signed integers. It multiplies these integers and places the least significant 32 bits of the result in *RdLo*, and the most significant 32 bits of the result in *RdHi*.

The SMLAL instruction interprets the values from *Rn* and *Rm* as two's complement signed integers. It multiplies these integers, adds the 64-bit result to the 64-bit signed integer contained in *RdHi* and *RdLo*, and writes the result back to *RdHi* and *RdLo*.

Restrictions

In these instructions:

- Do not use SP and do not use PC.
- *RdHi* and *RdLo* must be different registers.

Condition flags

These instructions do not affect the condition code flags.

Examples

```
UMULL    R0, R4, R5, R6    ; Unsigned (R4,R0) = R5 x R6
SMLAL   R4, R5, R3, R8    ; Signed (R5,R4) = (R5,R4) + R3 x R8
```

3.6.12 SDIV and UDIV

Signed Divide and Unsigned Divide.

Syntax

```
SDIV{cond} {Rd,} Rn, Rm
```

```
UDIV{cond} {Rd,} Rn, Rm
```

Where:

cond Is an optional condition code. See [Conditional execution on page 68](#).

Rd Is the destination register. If *Rd* is omitted, the destination register is *Rn*.

Rn Is the register holding the value to be divided.

Rm Is a register holding the divisor.

Operation

The SDIV instruction performs a signed integer division of the value in *Rn* by the value in *Rm*.

The UDIV instruction performs an unsigned integer division of the value in *Rn* by the value in *Rm*.

For both instructions, if the value in *Rn* is not divisible by the value in *Rm*, the result is rounded towards zero.

Restrictions

Do not use SP and do not use PC.

Condition flags

These instructions do not change the flags.

Examples

```
SDIV R0, R2, R4 ; Signed divide, R0 = R2/R4  
UDIV R8, R8, R1 ; Unsigned divide, R8 = R8/R1
```

3.7 Saturating instructions

[Table 32](#) shows the saturating instructions:

Table 32. Saturating instructions

Mnemonic	Brief description	See
SSAT	Signed Saturate	SSAT and USAT on page 129
SSAT16	Signed Saturate Halfword	SSAT16 and USAT16 on page 130
USAT	Unsigned Saturate	SSAT and USAT on page 129
USAT16	Unsigned Saturate Halfword	SSAT16 and USAT16 on page 130
QADD	Saturating Add	QADD and QSUB on page 131
QSUB	Saturating Subtract	QADD and QSUB on page 131
QSUB16	Saturating Subtract 16	QADD and QSUB on page 131
QASX	Saturating Add and Subtract with Exchange	QASX and QSAX on page 132
QSAX	Saturating Subtract and Add with Exchange	QASX and QSAX on page 132
QDADD	Saturating Double and Add	QDADD and QDSUB on page 133
QDSUB	Saturating Double and Subtract	QDADD and QDSUB on page 133
UQADD16	Unsigned Saturating Add 16	UQADD and UQSUB on page 136
UQADD8	Unsigned Saturating Add 8	UQADD and UQSUB on page 136
UQASX	Unsigned Saturating Add and Subtract with Exchange	UQASX and UQSAX on page 134
UQSAX	Unsigned Saturating Subtract and Add with Exchange	UQASX and UQSAX on page 134
UQSUB16	Unsigned Saturating Subtract 16	UQADD and UQSUB on page 136
UQSUB8	Unsigned Saturating Subtract 8	UQADD and UQSUB on page 136

For signed n -bit saturation, this means that:

- If the value to be saturated is less than -2^{n-1} , the result returned is -2^{n-1}
- If the value to be saturated is greater than $2^{n-1}-1$, the result returned is $2^{n-1}-1$
- Otherwise, the result returned is the same as the value to be saturated.

For unsigned n -bit saturation, this means that:

- If the value to be saturated is less than 0, the result returned is 0
- If the value to be saturated is greater than 2^n-1 , the result returned is 2^n-1
- Otherwise, the result returned is the same as the value to be saturated.

If the returned result is different from the value to be saturated, it is called *saturation*. If the saturation occurs, the instruction sets the Q flag to 1 in the APSR. Otherwise, it leaves the Q flag unchanged. To clear the Q flag to 0, the MSR instruction must be used, see [MSR on page 179](#).

To read the state of the Q flag, use the MRS instruction, see [MRS on page 178](#).

3.7.1 SSAT and USAT

Signed Saturate and Unsigned Saturate to any bit position, with optional shift before saturating.

Syntax

```
op{cond} Rd, #n, Rm {, shift #s}
```

Where:

<i>op</i>	Is one of: SSAT Saturates a signed value to a signed range. USAT Saturates a signed value to an unsigned range.
<i>cond</i>	Is an optional condition code. See Conditional execution on page 68 .
<i>Rd</i>	Is the destination register.
<i>n</i>	Specifies the bit position to saturate to: • <i>n</i> ranges from 1 to 32 for SSAT. • <i>n</i> ranges from 0 to 31 for USAT.
<i>Rm</i>	Is the register containing the value to saturate.
<i>shift #s</i>	Is an optional shift applied to <i>Rm</i> before saturating. It must be one of the following: ASR # <i>s</i> where <i>s</i> is in the range 1 to 31. LSL # <i>s</i> where <i>s</i> is in the range 0 to 31.

Operation

These instructions saturate to a signed or unsigned *n*-bit value.

The SSAT instruction applies the specified shift, then saturates to the signed range $-2^{n-1} \leq x \leq 2^{n-1}-1$.

The USAT instruction applies the specified shift, then saturates to the unsigned range $0 \leq x \leq 2^n-1$.

Restrictions

Do not use SP and do not use PC.

Condition flags

These instructions do not affect the condition code flags.

If saturation occurs, these instructions set the Q flag to 1.

Examples

```
SSAT    R7, #16, R7, LSL #4 ; Logical shift left value in R7 by 4,
                               ; then saturate it as a signed 16-bit
                               ; value and write it back to R7.
USATNE  R0, #7, R5         ; Conditionally saturate value in R5 as a
                               ; an unsigned 7 bit value and write it to
                               ; R0.
```

3.7.2 SSAT16 and USAT16

Signed Saturate and Unsigned Saturate to any bit position for two halfwords.

Syntax

```
op{cond} Rd, #n, Rm
```

Where:

<i>op</i>	Is one of: SSAT16 Saturates a signed halfword value to a signed range. USAT16 Saturates a signed halfword value to an unsigned range.
<i>cond</i>	Is an optional condition code. See Conditional execution on page 68 .
<i>Rd</i>	Is the destination register.
<i>n</i>	Specifies the bit position to saturate to: <ul style="list-style-type: none"> <i>n</i> ranges from 1 to 16 for SSAT. <i>n</i> ranges from 0 to 15 for USAT.
<i>Rm</i>	Is the register containing the value to saturate.

Operation

The SSAT16 instruction:

1. Saturates two signed 16-bit halfword values of the register with the value to saturate from selected by the bit position in *n*.
2. Writes the results as two signed 16-bit halfwords to the destination register.

The USAT16 instruction:

1. Saturates two unsigned 16-bit halfword values of the register with the value to saturate from selected by the bit position in *n*.
2. Writes the results as two unsigned halfwords in the destination register.

Restrictions

Do not use SP and do not use PC.

Condition flags

These instructions do not affect the condition code flags.

If saturation occurs, these instructions set the Q flag to 1.

Examples

```
SSAT16    R7, #9, R2      ; Saturates the top and bottom highwords of R2
                          ; as 9-bit values, writes to corresponding
                          ; halfword of R7.
USAT16NE  R0, #13, R5    ; Conditionally saturates the top and bottom
                          ; halfwords of R5 as 13-bit values, writes to
                          ; corresponding halfword of R0.
```

3.7.3 QADD and QSUB

Saturating Add and Saturating Subtract, signed.

Syntax

```
op{cond} {Rd}, Rn, Rm
```

```
op{cond} {Rd}, Rn, Rm
```

Where:

op Is one of:

QADD Saturating 32-bit add.

QADD8 Saturating four 8-bit integer additions.

QADD16 Saturating two 16-bit integer additions.

QSUB Saturating 32-bit subtraction.

QSUB8 Saturating four 8-bit integer subtraction.

QSUB16 Saturating two 16-bit integer subtraction.

cond Is an optional condition code. See [Conditional execution on page 68](#).

Rd Is the destination register.

Rn, Rm Are registers holding the first and second operands.

Operation

These instructions add or subtract two, four or eight values from the first and second operands and then writes a signed saturated value in the destination register.

The QADD and QSUB instructions apply the specified add or subtract, and then saturate the result to the signed range $-2^{n-1} \leq x \leq 2^{n-1}-1$, where *x* is given by the number of bits applied in the instruction, 32, 16 or 8.

If the returned result is different from the value to be saturated, it is called *saturation*. If saturation occurs, the QADD and QSUB instructions set the Q flag to 1 in the APSR. Otherwise, it leaves the Q flag unchanged. The 8-bit and 16-bit QADD and QSUB instructions always leave the Q flag unchanged.

To clear the Q flag to 0, the MSR instruction must be used, see [MSR on page 179](#).

To read the state of the Q flag, use the MRS instruction, see [MRS on page 178](#).

Restrictions

Do not use SP and do not use PC.

Condition flags

These instructions do not affect the condition code flags.

If saturation occurs, these instructions set the Q flag to 1.

Examples

```
QADD16 R7, R4, R2 ; Adds halfwords of R4 with corresponding halfword of
                  ; R2, saturates to 16 bits and writes to
                  ; corresponding halfword of R7.
```

QADD8	R3, R1, R6	; Adds bytes of R1 to the corresponding bytes of R6, ; saturates to 8 bits and writes to corresponding ; byte of R3.
QSUB16	R4, R2, R3	; Subtracts halfwords of R3 from corresponding ; halfword of R2, saturates to 16 bits, writes to ; corresponding halfword of R4.
QSUB8	R4, R2, R5	; Subtracts bytes of R5 from the corresponding byte ; in R2, saturates to 8 bits, writes to corresponding ; byte of R4.

3.7.4 QASX and QSAX

Saturating Add and Subtract with Exchange and Saturating Subtract and Add with Exchange, signed.

Syntax

`op{cond} {Rd}, Rm, Rn`

Where:

`op` Is one of:

- QASX Add and Subtract with Exchange and Saturate.
- QSAX Subtract and Add with Exchange and Saturate.

`cond` Is an optional condition code. See [Conditional execution on page 68](#).

`Rd` Is the destination register.

`Rn, Rm` Are registers holding the first and second operands.

Operation

The QASX instruction:

1. Adds the top halfword of the source operand with the bottom halfword of the second operand.
2. Subtracts the top halfword of the second operand from the bottom highword of the first operand.
3. Saturates the result of the subtraction and writes a 16-bit signed integer in the range $-2^{15} \leq x \leq 2^{15} - 1$, where x equals 16, to the bottom halfword of the destination register.
4. Saturates the results of the sum and writes a 16-bit signed integer in the range $-2^{15} \leq x \leq 2^{15} - 1$, where x equals 16, to the top halfword of the destination register.

The QSAX instruction:

1. Subtracts the bottom halfword of the second operand from the top highword of the first operand.
2. Adds the bottom halfword of the source operand with the top halfword of the second operand.
3. Saturates the results of the sum and writes a 16-bit signed integer in the range $-2^{15} \leq x \leq 2^{15} - 1$, where x equals 16, to the bottom halfword of the destination register.
4. Saturates the result of the subtraction and writes a 16-bit signed integer in the range $-2^{15} \leq x \leq 2^{15} - 1$, where x equals 16, to the top halfword of the destination register.

Restrictions

Do not use SP and do not use PC.

Condition flags

These instructions do not affect the condition code flags.

Examples

```

QASX    R7, R4, R2    ; Adds top halfword of R4 to bottom halfword of R2,
                    ; saturates to 16 bits, writes to top halfword of
                    ; R7, Subtracts top highword of R2 from bottom
                    ; halfword of R4, saturates to 16 bits and writes
                    ; to bottom halfword of R7
QSAX    R0, R3, R5    ; Subtracts bottom halfword of R5 from top halfword
                    ; of R3, saturates to 16 bits, writes to top
                    ; halfword of R0
                    ; Adds bottom halfword of R3 to top halfword of R5,
                    ; saturates to 16 bits, writes to bottom halfword
                    ; of R0.

```

3.7.5 QDADD and QDSUB

Saturating Double and Add and Saturating Double and Subtract, signed.

Syntax

op{*cond*} {*Rd*}, *Rm*, *Rn*

Where:

op Is one of:

 QDADD Saturating Double and Add.

 QDSUB Saturating Double and Subtract.

cond Is an optional condition code. See [Conditional execution on page 68](#).

Rd Is the destination register.

Rm, *Rn* Are registers holding the first and second operands.

Operation

The QDADD instruction:

- Doubles the second operand value.
- Adds the result of the doubling to the signed saturated value in the first operand.
- Writes the result to the destination register.

The QDSUB instruction:

- Doubles the second operand value.
- Subtracts the doubled value from the signed saturated value in the first operand.
- Writes the result to the destination register.

Both the doubling and the addition or subtraction have their results saturated to the 32-bit signed integer range $-2^{31} \leq x \leq 2^{31} - 1$. If saturation occurs in either operation, it sets the Q flag in the APSR.

Restrictions

Do not use SP and do not use PC.

Condition flags

If saturation occurs, these instructions set the Q flag to 1.

Examples

```
QDADD   R7, R4, R2           ; Doubles and saturates R4 to 32 bits, adds R2,
                               ; Saturates to 32 bits, writes to R7
QDSUB   R0, R3, R5           ; Subtracts R3 doubled and saturated to 32 bits
                               ; from R5, saturates to 32 bits, writes to R0.
```

3.7.6 UQASX and UQSAX

Saturating Add and Subtract with Exchange and Saturating Subtract and Add with Exchange, unsigned.

Syntax

```
op{cond} {Rd}, Rm, Rn
```

Where:

type Is one of:
 UQASX Add and Subtract with Exchange and Saturate.
 UQSAX Subtract and Add with Exchange and Saturate.

cond Is an optional condition code. See [Conditional execution on page 68](#).

Rd Is the destination register.

Rn, Rm Are registers holding the first and second operands.

Operation

The UQASX instruction:

1. Adds the bottom halfword of the source operand with the top halfword of the second operand.
2. Subtracts the bottom halfword of the second operand from the top highword of the first operand.
3. Saturates the results of the sum and writes a 16-bit unsigned integer in the range $0 \leq x \leq 2^{16} - 1$, where x equals 16, to the top halfword of the destination register.
4. Saturates the result of the subtraction and writes a 16-bit unsigned integer in the range $0 \leq x \leq 2^{16} - 1$, where x equals 16, to the bottom halfword of the destination register.

The UQSAX instruction:

1. Subtracts the bottom halfword of the second operand from the top highword of the first operand.
2. Adds the bottom halfword of the first operand with the top halfword of the second operand.
3. Saturates the result of the subtraction and writes a 16-bit unsigned integer in the range $0 \leq x \leq 2^{16} - 1$, where x equals 16, to the top halfword of the destination register.
4. Saturates the results of the addition and writes a 16-bit unsigned integer in the range $0 \leq x \leq 2^{16} - 1$, where x equals 16, to the bottom halfword of the destination register.

Restrictions

Do not use SP and do not use PC.

Condition flags

These instructions do not affect the condition code flags.

Examples

```
UQASX  R7, R4, R2 ; Adds top halfword of R4 with bottom halfword of R2,  
                  ; saturates to 16 bits, writes to top halfword of R7  
                  ; Subtracts top halfword of R2 from bottom halfword of  
                  ; R4, saturates to 16 bits, writes to bottom halfword  
                  ; of R7  
UQSAX  R0, R3, R5 ; Subtracts bottom halfword of R5 from top halfword of  
                  ; R3, saturates to 16 bits, writes to top halfword of  
                  ; R0  
                  ; Adds bottom halfword of R4 to top halfword of R5  
                  ; saturates to 16 bits, writes to bottom halfword of  
                  ; R0.
```

3.7.7 UQADD and UQSUB

Saturating Add and Saturating Subtract Unsigned.

Syntax

$op\{cond\} \{Rd\}, Rn, Rm$

$op\{cond\} \{Rd\}, Rn, Rm$

Where:

op Is one of:

UQADD8 Saturating four unsigned 8-bit integer additions.

UQADD16 Saturating two unsigned 16-bit integer additions.

UDSUB8 Saturating four unsigned 8-bit integer subtractions.

UQSUB16 Saturating two unsigned 16-bit integer subtractions.

$cond$ Is an optional condition code. See [Conditional execution on page 68](#).

Rd Is the destination register.

Rn, Rm Are registers holding the first and second operands.

Operation

These instructions add or subtract two or four values and then writes an unsigned saturated value in the destination register.

The UQADD16 instruction:

- Adds the respective top and bottom halfwords of the first and second operands.
- Saturates the result of the additions for each halfword in the destination register to the unsigned range $0 \leq x \leq 2^{16}-1$, where x is 16.

The UQADD8 instruction:

- Adds each respective byte of the first and second operands.
- Saturates the result of the addition for each byte in the destination register to the unsigned range $0 \leq x \leq 2^8-1$, where x is 8.

The UQSUB16 instruction:

- Subtracts both halfwords of the second operand from the respective halfwords of the first operand.
- Saturates the result of the differences in the destination register to the unsigned range $0 \leq x \leq 2^{16}-1$, where x is 16.

The UQSUB8 instructions:

- Subtracts the respective bytes of the second operand from the respective bytes of the first operand.
- Saturates the results of the differences for each byte in the destination register to the unsigned range $0 \leq x \leq 2^8-1$, where x is 8.

Restrictions

Do not use SP and do not use PC.

Condition flags

These instructions do not affect the condition code flags.

Examples

```

UQADD16  R7, R4, R2 ; Adds halfwords in R4 to corresponding halfword in
                    ; R2, saturates to 16 bits, writes to corresponding
                    ; halfword of R7
UQADD8   R4, R2, R5 ; Adds bytes of R2 to corresponding byte of R5,
                    ; saturates to 8 bits, writes to corresponding bytes
                    ; of R4
UQSUB16  R6, R3, R0 ; Subtracts halfwords in R0 from corresponding
                    ; halfword in R3, saturates to 16 bits, writes to
                    ; corresponding halfword in R6
UQSUB8   R1, R5, R6 ; Subtracts bytes in R6 from corresponding byte of
                    ; R5, saturates to 8 bits, writes to corresponding
                    ; byte of R1.

```

3.8 Packing and unpacking instructions

[Table 33](#) shows the instructions that operate on packing and unpacking data:

Table 33. Packing and unpacking instructions

Mnemonic	Brief description	See
PKH	Pack Halfword	PKHBT and PKHTB on page 138
SXTAB	Extend 8 bits to 32 and add	SXTA and UXTA on page 140
SXTAB16	Dual extend 8 bits to 16 and add	SXTA and UXTA on page 140
SXTAH	Extend 16 bits to 32 and add	SXTA and UXTA on page 140
SXTB	Sign extend a byte	SXT and UXT on page 144
SXTB16	Dual extend 8 bits to 16 and add	SXT and UXT on page 144
SXTH	Sign extend a halfword	SXT and UXT on page 144
UXTAB	Extend 8 bits to 32 and add	SXTA and UXTA on page 140
UXTAB16	Dual extend 8 bits to 16 and add	SXTA and UXTA on page 140
UXTAH	Extend 16 bits to 32 and add	SXTA and UXTA on page 140
UXTB	Zero extend a byte	SXT and UXT on page 144
UXTB16	Dual zero extend 8 bits to 16 and add	SXT and UXT on page 144
UXTH	Zero extend a halfword	SXT and UXT on page 144

3.8.1 PKHBT and PKHTB

Pack Halfword.

Syntax

```
op{cond} {Rd}, Rn, Rm {, LSL #imm}
```

```
op{cond} {Rd}, Rn, Rm {, ASR #imm}
```

Where:

op Is one of:

PKHBT Pack Halfword, bottom and top with shift.

PKHTB Pack Halfword, top and bottom with shift.

cond Is an optional condition code. See [Conditional execution on page 68](#).

Rd Is the destination register.

Rn Is the first operand register.

Rm Is the second operand register holding the value to be optionally shifted.

imm Is the shift length. The type of shift length depends on the instruction:

For PKHBT

LSL A left shift with a shift length from 1 to 31, 0 means no shift.

For PKHTB:

ASR An arithmetic shift right with a shift length from 1 to 32, a shift of 32-bits is encoded as 0b00000.

Operation

The PKHBT instruction:

1. Writes the value of the bottom halfword of the first operand to the bottom halfword of the destination register.
2. If shifted, the shifted value of the second operand is written to the top halfword of the destination register.

The PKHTB instruction:

1. Writes the value of the top halfword of the first operand to the top halfword of the destination register.
2. If shifted, the shifted value of the second operand is written to the bottom halfword of the destination register.

Restrictions

Rd must not be SP and must not be PC.

Condition flags

This instruction does not change the flags.

Examples

```
PKHBT   R3, R4, R5 LSL #0 ; Writes bottom halfword of R4 to bottom
                          ; halfword of R3, writes top halfword of R5,
                          ; unshifted, to top halfword of R3
PKHTB   R4, R0, R2 ASR #1 ; Writes R2 shifted right by 1 bit to bottom
                          ; halfword of R4, and writes top halfword of R0
                          ; to top halfword of R4.
```

3.8.2 SXT and UXT

Sign extend and Zero extend.

Syntax

```
op{cond} {Rd,} Rm {, ROR #n}
```

```
op{cond} {Rd}, Rm {, ROR #n}
```

Where:

op Is one of:

- SXTB Sign extends an 8-bit value to a 32-bit value.
- SXTH Sign extends a 16-bit value to a 32-bit value.
- SXTB16 Sign extends two 8-bit values to two 16-bit values.
- UXTB Zero extends an 8-bit value to a 32-bit value.
- UXTH Zero extends a 16-bit value to a 32-bit value.
- UXTB16 Zero extends two 8-bit values to two 16-bit values.

cond Is an optional condition code. See [Conditional execution on page 68](#).

Rd Is the destination register.

Rm Is the register holding the value to extend.

ROR #*n* Is one of:

- ROR #8 Value from *Rm* is rotated right 8 bits.
 - ROR #16 Value from *Rm* is rotated right 16 bits.
 - ROR #24 Value from *Rm* is rotated right 24 bits.
- If ROR #*n* is omitted, no rotation is performed.

Operation

These instructions do the following:

1. Rotate the value from *Rm* right by 0, 8, 16 or 24 bits.
2. Extract bits from the resulting value:
 - SXTB extracts bits[7:0] and sign extends to 32 bits.
 - UXTB extracts bits[7:0] and zero extends to 32 bits.
 - SXTH extracts bits[15:0] and sign extends to 32 bits.
 - UXTH extracts bits[15:0] and zero extends to 32 bits.
 - SXTB16 extracts bits[7:0] and sign extends to 16 bits, and extracts bits [23:16] and sign extends to 16 bits.
 - UXTB16 extracts bits[7:0] and zero extends to 16 bits, and extracts bits [23:16] and zero extends to 16 bits.

Restrictions

Do not use SP and do not use PC.

Condition flags

These instructions do not affect the flags.

Examples

```
SXTH R4, R6, ROR #16 ; Rotates R6 right by 16 bits, obtains bottom
                    ; halfword of result, sign extends to 32 bits and
                    ; writes to R4
UXTB R3, R10        ; Extracts lowest byte of value in R10, zero
                    ; extends, and writes to R3.
```

3.8.3 SXTA and UXTA

Signed and Unsigned Extend and Add.

Syntax

```
op{cond} {Rd,} Rn, Rm {, ROR #n}
```

```
op{cond} {Rd,} Rn, Rm {, ROR #n}
```

Where:

<i>op</i>	Is one of: SXTAB Sign extends an 8-bit value to a 32-bit value and add. SXTAH Sign extends a 16-bit value to a 32-bit value and add. SXTAB16 Sign extends two 8-bit values to two 16-bit values and add. UXTAB Zero extends an 8-bit value to a 32-bit value and add. UXTAH Zero extends a 16-bit value to a 32-bit value and add. UXTAB16 Zero extends two 8-bit values to two 16-bit values and add.
<i>cond</i>	Is an optional condition code. See Conditional execution on page 68 .
<i>Rd</i>	Is the destination register.
<i>Rn</i>	Is the first operand register.
<i>Rm</i>	Is the register holding the value to rotate and extend.
ROR # <i>n</i>	Is one of: ROR #8 Value from <i>Rm</i> is rotated right 8 bits. ROR #16 Value from <i>Rm</i> is rotated right 16 bits. ROR #24 Value from <i>Rm</i> is rotated right 24 bits. If ROR # <i>n</i> is omitted, no rotation is performed.

Operation

These instructions do the following:

1. Rotate the value from *Rm* right by 0, 8, 16 or 24 bits.
2. Extract bits from the resulting value:
 - SXTAB extracts bits[7:0] from *Rm* and sign extends to 32 bits.
 - UXTAB extracts bits[7:0] from *Rm* and zero extends to 32 bits.

- SXTAH extracts bits[15:0] from *Rm* and sign extends to 32 bits.
 - UXTAH extracts bits[15:0] from *Rm* and zero extends to 32 bits.
 - SXTAB16 extracts bits[7:0] from *Rm* and sign extends to 16 bits, and extracts bits [23:16] from *Rm* and sign extends to 16 bits.
 - UXTAB16 extracts bits[7:0] from *Rm* and zero extends to 16 bits, and extracts bits [23:16] from *Rm* and zero extends to 16 bits.
3. Adds the signed or zero extended value to the word or corresponding halfword of *Rn* and writes the result in *Rd*.

Restrictions

Do not use SP and do not use PC.

Condition flags

These instructions do not affect the flags.

Examples

```
SXTAH  R4, R8, R6, ROR #16 ; Rotates R6 right by 16 bits, obtains bottom
                           ; halfword, sign extends to 32 bits, adds
                           ; R8, and writes to R4
UXTAB  R3, R4, R10        ; Extracts bottom byte of R10 and zero extends
                           ; to 32 bits, adds R4, and writes to R3.
```

3.9 Bit field instructions

[Table 34](#) shows the instructions that operate on adjacent sets of bits in registers or bit fields:

Table 34. Packing and unpacking instructions

Mnemonic	Brief description	See
BFC	Bit Field Clear	BFC and BFI on page 142
BFI	Bit Field Insert	BFC and BFI on page 142
SBFX	Signed Bit Field Extract	SBFX and UBFX on page 143
SXTB	Sign extend a byte	SXT and UXT on page 144
SXTH	Sign extend a halfword	SXT and UXT on page 144
UBFX	Unsigned Bit Field Extract	SBFX and UBFX on page 143
UXTB	Zero extend a byte	SXT and UXT on page 144
UXTH	Zero extend a halfword	SXT and UXT on page 144

3.9.1 BFC and BFI

Bit Field Clear and Bit Field Insert.

Syntax

```
BFC{cond} Rd, #lsb, #width
```

```
BFI{cond} Rd, Rn, #lsb, #width
```

Where:

cond Is an optional condition code. See [Conditional execution on page 68](#).

Rd Is the destination register.

Rn Is the source register.

lsb Is the position of the least significant bit of the bit field. *lsb* must be in the range 0 to 31.

width Is the width of the bit field and must be in the range 1 to 32-*lsb*.

Operation

BFC clears a bit field in a register. It clears *width* bits in *Rd*, starting at the low bit position *lsb*. Other bits in *Rd* are unchanged.

BFI copies a bit field into one register from another register. It replaces *width* bits in *Rd* starting at the low bit position *lsb*, with *width* bits from *Rn* starting at bit[0]. Other bits in *Rd* are unchanged.

Restrictions

Do not use SP and do not use PC.

Condition flags

These instructions do not affect the flags.

Examples

```
BFC  R4, #8, #12    ; Clear bit 8 to bit 19 (12 bits) of R4 to 0
BFI  R9, R2, #8, #12 ; Replace bit 8 to bit 19 (12 bits) of R9 with
                    ; bit 0 to bit 11 from R2.
```

3.9.2 SBFX and UBFX

Signed Bit Field Extract and Unsigned Bit Field Extract.

Syntax

```
SBFX{cond} Rd, Rn, #lsb, #width
```

```
UBFX{cond} Rd, Rn, #lsb, #width
```

Where:

cond Is an optional condition code. See [Conditional execution on page 68](#).

Rd Is the destination register.

Rn Is the source register.

lsb Is the position of the least significant bit of the bit field. *lsb* must be in the range 0 to 31.

width Is the width of the bit field and must be in the range 1 to 32-*lsb*.

Operation

SBFX extracts a bit field from one register, sign extends it to 32 bits, and writes the result to the destination register.

UBFX extracts a bit field from one register, zero extends it to 32 bits, and writes the result to the destination register.

Restrictions

Do not use SP and do not use PC.

Condition flags

These instructions do not affect the flags.

Examples

```
SBFX R0, R1, #20, #4 ; Extract bit 20 to bit 23 (4 bits) from R1 and
                    ; sign extend to 32 bits and then write the
                    ; result to R0.
UBFX R8, R11, #9, #10 ; Extract bit 9 to bit 18 (10 bits) from R11 and
                    ; zero extend to 32 bits and then write the
                    ; result to R8.
```

3.9.3 SXT and UXT

Sign extend and Zero extend.

Syntax

```
SXTextend{cond} {Rd}, Rm {, ROR #n}
```

```
UXTextend{cond} {Rd}, Rm {, ROR #n}
```

Where:

<i>extend</i>	Is one of:
B	Extends an 8-bit value to a 32-bit value.
H	Extends a 16-bit value to a 32-bit value.
<i>cond</i>	Is an optional condition code. See Conditional execution on page 68 .
<i>Rd</i>	Is the destination register.
<i>Rm</i>	Is the register holding the value to extend.
ROR # <i>n</i>	Is one of:
ROR #8	Value from <i>Rm</i> is rotated right 8 bits.
ROR #16	Value from <i>Rm</i> is rotated right 16 bits.
ROR #24	Value from <i>Rm</i> is rotated right 24 bits.
	If ROR # <i>n</i> is omitted, no rotation is performed.

Operation

These instructions do the following:

1. Rotate the value from *Rm* right by 0, 8, 16 or 24 bits.
2. Extract bits from the resulting value:
 - SXTB extracts bits[7:0] and sign extends to 32 bits.
 - UXTB extracts bits[7:0] and zero extends to 32 bits.
 - SXTH extracts bits[15:0] and sign extends to 32 bits.
 - UXTH extracts bits[15:0] and zero extends to 32 bits.

Restrictions

Do not use SP and do not use PC.

Condition flags

These instructions do not affect the flags.

Examples

```
SXTH R4, R6, ROR #16 ; Rotate R6 right by 16 bits, then obtain the
                    ; lower halfword of the result and then sign
                    ; extend to 32 bits and write the result to R4.
UXTB R3, R10        ; Extract lowest byte of the value in R10 and
                    ; zero extend it, and write the result to R3.
```

3.10 Branch and control instructions

[Table 35](#) shows the branch and control instructions:

Table 35. Branch and control instructions

Mnemonic	Brief description	See
B	Branch	B, BL, BX, and BLX on page 145
BL	Branch with Link	B, BL, BX, and BLX on page 145
BLX	Branch indirect with Link	B, BL, BX, and BLX on page 145
BX	Branch indirect	B, BL, BX, and BLX on page 145
CBNZ	Compare and Branch if Non Zero	CBZ and CBNZ on page 147
CBZ	Compare and Branch if Zero	CBZ and CBNZ on page 147
IT	If-Then	IT on page 148
TBB	Table Branch Byte	TBB and TBH on page 150
TBH	Table Branch Halfword	TBB and TBH on page 150

3.10.1 B, BL, BX, and BLX

Branch instructions.

Syntax

$B\{cond\}$ *label*

$BL\{cond\}$ *label*

$BX\{cond\}$ *Rm*

$BLX\{cond\}$ *Rm*

Where:

B Is branch (immediate).

BL Is branch with link (immediate).

BX Is branch indirect (register).

BLX Is branch indirect with link (register).

cond Is an optional condition code. See [Conditional execution on page 68](#).

label Is a PC-relative expression. See [PC-relative expressions on page 68](#).

Rm Is a register that indicates an address to branch to. Bit[0] of the value in *Rm* must be 1, but the address to branch to is created by changing bit[0] to 0.

Operation

All these instructions cause a branch to *label*, or to the address indicated in *Rm*. In addition:

- The BL and BLX instructions write the address of the next instruction to LR (the link register, R14).
- The BX and BLX instructions result in a UsageFault exception if bit[0] of *Rm* is 0.

Bcond label is the only conditional instruction that can be either inside or outside an IT block. All other branch instructions must be conditional inside an IT block, and must be unconditional outside the IT block, see [IT on page 148](#).

[Table 36](#) shows the ranges for the various branch instructions

Table 36. Branch ranges

Instruction	Branch range
B label	-16 MB to +16 MB
<i>Bcond</i> label (outside IT block)	-1 MB to +1 MB
<i>Bcond</i> label (inside IT block)	-16 MB to +16 MB
BL{ <i>cond</i> } label	-16 MB to +16 MB
BX{ <i>cond</i> } Rm	Any value in register
BLX{ <i>cond</i> } Rm	Any value in register

The user might have to use the *.W* suffix to get the maximum branch range. See [Instruction width selection on page 71](#).

Restrictions

The restrictions are:

- Do not use PC in the BLX instruction.
- For BX and BLX, bit[0] of *Rm* must be 1 for correct execution but a branch occurs to the target address created by changing bit[0] to 0.
- When any of these instructions is inside an IT block, it must be the last instruction of the IT block.

Bcond is the only conditional instruction that is not required to be inside an IT block. However, it has a longer branch range when it is inside an IT block.

Condition flags

These instructions do not change the flags.

Examples

```

B      loopA ; Branch to loopA
BLE   ng    ; Conditionally branch to label ng
B.W   target ; Branch to target within 16MB range
BEQ   target ; Conditionally branch to target
BEQ.W target ; Conditionally branch to target within 1MB
BL    funC  ; Branch with link (Call) to function funC, return
        ; address stored in LR
BX    LR    ; Return from function call
BXNE  R0    ; Conditionally branch to address stored in R0
BLX   R0    ; Branch with link and exchange (Call) to a address
        ; stored in R0.
    
```



3.10.2 CBZ and CBNZ

Compare and Branch on Zero, Compare and Branch on Non-Zero.

Syntax

```
CBZ Rn, label
```

```
CBNZ Rn, label
```

Where:

Rn Is the register holding the operand.

label Is the branch destination.

Operation

Use the CBZ or CBNZ instructions to avoid changing the condition code flags and to reduce the number of instructions.

CBZ *Rn*, *label* does not change condition flags but is otherwise equivalent to:

```
CMP    Rn, #0  
BEQ    label
```

CBNZ *Rn*, *label* does not change condition flags but is otherwise equivalent to:

```
CMP    Rn, #0  
BNE    label
```

Restrictions

The restrictions are:

- *Rn* must be in the range of R0 to R7.
- The branch destination must be within 4 to 130 bytes after the instruction.
- These instructions must not be used inside an IT block.

Condition flags

These instructions do not change the flags.

Examples

```
CBZ    R5, target ; Forward branch if R5 is zero  
CBNZ   R0, target ; Forward branch if R0 is not zero
```

3.10.3 IT

If-Then condition instruction.

Syntax

```
IT{x{y{z}}} cond
```

Where:

<i>x</i>	specifies the condition switch for the second instruction in the IT block.
<i>y</i>	Specifies the condition switch for the third instruction in the IT block.
<i>z</i>	Specifies the condition switch for the fourth instruction in the IT block.
<i>cond</i>	Specifies the condition for the first instruction in the IT block.

The condition switch for the second, third and fourth instruction in the IT block can be either:

T	Then. Applies the condition <i>cond</i> to the instruction.
E	Else. Applies the inverse condition of <i>cond</i> to the instruction.

It is possible to use AL (the *always* condition) for *cond* in an IT instruction. If this is done, all of the instructions in the IT block must be unconditional, and each of *x*, *y*, and *z* must be T or omitted but not E.

Operation

The IT instruction makes up to four following instructions conditional. The conditions can be all the same, or some of them can be the logical inverse of the others. The conditional instructions following the IT instruction form the *IT block*.

The instructions in the IT block, including any branches, must specify the condition in the {*cond*} part of their syntax.

The assembler might be able to generate the required IT instructions for conditional instructions automatically, so it is not needed to write them yourself. See the assembler documentation for details.

A BKPT instruction in an IT block is always executed, even if its condition fails.

Exceptions can be taken between an IT instruction and the corresponding IT block, or within an IT block. Such an exception results in entry to the appropriate exception handler, with suitable return information in LR and stacked PSR.

Instructions designed for use for exception returns can be used as normal to return from the exception, and execution of the IT block resumes correctly. This is the only way that a PC-modifying instruction is permitted to branch to an instruction in an IT block.

Restrictions

The following instructions are not permitted in an IT block:

- IT.
- CBZ and CBNZ.
- CPSID and CPSIE.

Other restrictions when using an IT block are:

- A branch or any instruction that modifies the PC must either be outside an IT block or must be the last instruction inside the IT block. These are:
 - ADD PC, PC, Rm.
 - MOV PC, Rm.
 - B, BL, BX, BLX.
 - Any LDM, LDR, or POP instruction that writes to the PC.
 - TBB and TBH.
- Do not branch to any instruction inside an IT block, except when returning from an exception handler
- All conditional instructions except *Bcond* must be inside an IT block. *Bcond* can be either outside or inside an IT block but has a larger branch range if it is inside one
- Each instruction inside the IT block must specify a condition code suffix that is either the same or logical inverse as for the other instructions in the block.

The assembler might place extra restrictions on the use of IT blocks, such as prohibiting the use of assembler directives within them.

Condition flags

This instruction does not change the flags.

Example

```

ITTE  NE           ; Next 3 instructions are conditional
ANDNE R0, R0, R1   ; ANDNE does not update condition flags
ADDSNE R2, R2, #1  ; ADDSNE updates condition flags
MOVEQ R2, R3       ; Conditional move

CMP   R0, #9       ; Convert R0 hex value (0 to 15) into ASCII
                        ; ('0'-'9', 'A'-'F')
ITE   GT           ; Next 2 instructions are conditional
ADDGT R1, R0, #55  ; Convert 0xA -> 'A'
ADDLE R1, R0, #48  ; Convert 0x0 -> '0'

IT    GT           ; IT block with only one conditional instruction
ADDGT R1, R1, #1   ; Increment R1 conditionally

ITTEE EQ           ; Next 4 instructions are conditional
MOVEQ R0, R1       ; Conditional move
ADDEQ R2, R2, #10  ; Conditional add
ANDNE R3, R3, #1   ; Conditional AND
BNE.W dloop        ; Branch instruction can only be used in the last
                        ; instruction of an IT block

IT    NE           ; Next instruction is conditional
ADD   R0, R0, R1   ; Syntax error: no condition code used in IT block

```

3.10.4 TBB and TBH

Table Branch Byte and Table Branch Halfword.

Syntax

```
TBB [Rn, Rm]
```

```
TBH [Rn, Rm, LSL #1]
```

Where:

- Rn* Is the register containing the address of the table of branch lengths.
If *Rn* is PC, then the address of the table is the address of the byte immediately following the TBB or TBH instruction.
- Rm* Is the index register. This contains an index into the table. For halfword tables, LSL #1 doubles the value in *Rm* to form the right offset into the table.

Operation

These instructions cause a PC-relative forward branch using a table of single byte offsets for TBB, or halfword offsets for TBH. *Rn* provides a pointer to the table, and *Rm* supplies an index into the table. For TBB the branch offset is twice the unsigned value of the byte returned from the table, and for TBH the branch offset is twice the unsigned value of the halfword returned from the table. The branch occurs to the address at that offset from the address of the byte immediately after the TBB or TBH instruction.

Restrictions

The restrictions are:

- *Rn* must not be SP.
- *Rm* must not be SP and must not be PC.
- When any of these instructions is used inside an IT block, it must be the last instruction of the IT block.

Condition flags

These instructions do not change the flags.

Examples

```
ADR.W R0, BranchTable_Byte
TBB [R0, R1] ; R1 is the index, R0 is the base address of
; the branch table

Case1
; an instruction sequence follows
Case2
; an instruction sequence follows
Case3
; an instruction sequence follows
BranchTable_Byte
DCB 0 ; Case1 offset calculation
DCB ((Case2-Case1)/2) ; Case2 offset calculation
DCB ((Case3-Case1)/2) ; Case3 offset calculation

TBH [PC, R1, LSL #1] ; R1 is the index, PC is used as base of the
```

```

; branch table
BranchTable_H
    DCW    ((CaseA - BranchTable_H)/2) ; CaseA offset calculation
    DCW    ((CaseB - BranchTable_H)/2) ; CaseB offset calculation
    DCW    ((CaseC - BranchTable_H)/2) ; CaseC offset calculation

CaseA
; an instruction sequence follows
CaseB
; an instruction sequence follows
CaseC
; an instruction sequence follows

```

3.11 Floating-point instructions

This section provides the instruction set that the single-precision and double-precision FPU uses.

[Table 37](#) shows the floating-point instructions.

These instructions are only available if the FPU is included, and enabled, in the system. See [Enabling the FPU on page 238](#) for information about enabling the floating-point unit.

Table 37. Floating-point instructions

Mnemonic	Brief description	See
VABS	Floating-point Absolute	VABS on page 153
VADD	Floating-point Add	VADD on page 153
VCMP	Compares two floating-point registers, or one floating-point register and zero	VCMP, VCMPE on page 154
VCMPE	Compares two floating-point registers, or one floating-point register and zero with Invalid Operation check	VCMP, VCMPE on page 154
VCVT	Converts between floating-point and integer	VCVT between floating-point and fixed-point on page 156
VCVT	Converts between floating-point and fixed point	VCVT between floating-point and fixed-point on page 156
VCVTR	Converts between floating-point and integer with rounding	VCVT, VCVTR between floating-point and integer on page 155
VCVTB	Converts half-precision value to single-precision	VCVTB, VCVTT on page 157
VCVTT	Converts single-precision register to half-precision	VCVTB, VCVTT on page 157
VDIV	Floating-point Divide	VDIV on page 157
VFMA	Floating-point Fused Multiply Accumulate	VFMA, VFMS on page 158
VFNMA	Floating-point Fused Negate Multiply Accumulate	VFNMA, VFNMS on page 159
VFMS	Floating-point Fused Multiply Subtract	VFMA, VFMS on page 158
VFNMS	Floating-point Fused Negate Multiply Subtract	VFNMA, VFNMS on page 159
VLDM	Loads Multiple extension registers	VLDM on page 159

Table 37. Floating-point instructions (continued)

Mnemonic	Brief description	See
VLDR	Loads an extension register from memory	VLDR on page 160
VMLA	Floating-point Multiply Accumulate	VMLA, VMLS on page 161
VMLS	Floating-point Multiply Subtract	VMLA, VMLS on page 161
VMOV	Floating-point Move Immediate	VMOV immediate on page 162
VMOV	Floating-point Move register	VMOV register on page 162
VMOV	Copies Arm core register to single-precision	VMOV Arm core register to single-precision on page 163
VMOV	Copies 2 Arm core registers to 2 single-precision	VMOV two Arm core registers to two single-precision registers on page 164
VMOV	Copies between Arm core register to scalar	VMOV Arm core register to scalar on page 165
VMOV	Copies between Scalar to Arm core register	VMOV scalar to Arm core register on page 163
VMRS	Moves to Arm core register from floating-point System register	VMRS on page 165
VMSR	Moves to floating-point System register from Arm core register	VMSR on page 166
VMUL	Multiplies floating-point	VMUL on page 166
VNEG	Floating-point negate	VNEG on page 167
VNMLA	Floating-point multiply and add	VNMLA, VNMLS, VNMUL on page 167
VNMLS	Floating-point multiply and subtract	VNMLA, VNMLS, VNMUL on page 167
VNMUL	Floating-point multiply	VNMLA, VNMLS, VNMUL on page 167
VPOP	Pop extension registers	VPOP on page 168
VPUSH	Pushes extension registers	VPUSH on page 169
VSQRT	Floating-point square root	VSQRT on page 169
VSTM	Stores Multiple extension registers	VSTM on page 170
VSTR	Stores an extension register to memory	VSTR on page 170
VSUB	Floating-point Subtract	VSUB on page 171
VSEL	Selects register, alternative to a pair of conditional VMOV	VSEL on page 172
VMAXNM, VMINNM	Maximum, Minimum with IEEE754-2008 NaN handling	VMAXNM, VMINNM on page 172
VCVTA, VCVTN, VCVTP, VCVTM	Float to integer conversion with directed rounding	VCVTA, VCVTN, VCVTP, VCVTM on page 173

Table 37. Floating-point instructions (continued)

Mnemonic	Brief description	See
VRINTR, VRINTX	Float to integer (in floating-point format) conversion	VRINTR, VRINTX on page 173
VRINTA, VRINTN, VRINTP, VRINTM	Float to integer (in floating-point format) conversion with directed rounding	VRINTA, VRINTN, VRINTP, VRINTM, VRINTZ on page 174

3.11.1 VABS

Floating-point Absolute.

Syntax

VABS{*cond*}.F<32|64> <*Sd*/*Dd*>, <*Sm*/*Dm*>

Where:

cond Is an optional condition code. See [Conditional execution on page 68](#).

<*Sd*/*Dd*>, <*Sm*/*Dm*>

Are the destination floating-point value and the operand floating-point value.

Operation

This instruction:

1. Takes the absolute value of the operand floating-point register.
2. Places the results in the destination floating-point register.

Restrictions

There are no restrictions.

Condition flags

This instruction does not change the flags.

Examples

VABS.F32 S4, S6

3.11.2 VADD

Floating-point Add.

Syntax

VADD{*cond*}.F<32|64> {<*Sd*/*Dd*>, } <*Sn*/*Dn*>, <*Sm*/*Dm*>

VADD{*cond*}.F64 {*Dd*, } *Dn*, *Dm*

Where:

cond Is an optional condition code. See [Conditional execution on page 68](#).

<*Sd*/*Dd*> Is the destination floating-point value.

$\langle S_n / D_n \rangle, \langle S_m / D_m \rangle$

Are the operand floating-point values.

Operation

This instruction:

1. Adds the values in the two floating-point operand registers.
2. Places the results in the destination floating-point register.

Restrictions

There are no restrictions.

Condition flags

This instruction does not change the flags.

Examples

```
VADD.F32 S4, S6, S7
```

3.11.3 VCMP, VCMPE

Compares two floating-point registers, or one floating-point register and zero.

Syntax

```
VCMP{E}{cond}.F<32|64> <Sd/Dd>, <Sm/Dm>
```

```
VCMP{E}{cond}.F<32|64> <Sd/Dd>, #0.0
```

Where:

<i>cond</i>	Is an optional condition code. See Conditional execution on page 68 .
<i>E</i>	If present, any NaN operand causes an Invalid Operation exception. Otherwise, only a signaling NaN causes the exception.
$\langle S_d / D_d \rangle$	Is the floating-point operand to compare.
$\langle S_m / D_m \rangle$	Is the floating-point operand that is compared with.

Operation

This instruction:

1. Compares either:
 - Two floating-point registers.
 - Or one floating-point register and zero.
2. Writes the result to the FPSCR flags.

Restrictions

This instruction can optionally raise an Invalid Operation exception if either operand is any type of NaN. It always raises an Invalid Operation exception if either operand is a signaling NaN.

Condition flags

When this instruction writes the result to the FPSCR flags, the values are normally transferred to the Arm flags by a subsequent VMRS instruction, see [VMRS on page 165](#).

Examples

```
VCMP.F32 S4, #0.0VCMP.F32 S4, S2
```

3.11.4 VCVT, VCVTR between floating-point and integer

Converts a value in a register from floating-point to and from a 32-bit integer.

Syntax

```
VCVT{R}{cond}.Tm.F<32|64> <Sd|Dd>, <Sm|Dm>
```

```
VCVT{cond}.F<32|64>.Tm <Sd|Dd>, <Sm|Dm>
```

Where:

R If *R* is specified, the operation uses the rounding mode specified by the FPSCR. If *R* is omitted, the operation uses the Round towards Zero rounding mode.

cond Is an optional condition code. See [Conditional execution on page 68](#).

Tm Is the data type for the operand. It must be one of:

- S32 signed 32-bit value.
- U32 unsigned 32-bit value.

<*Sd|Dd*>, <*Sm|Dm*>

Are the destination register and the operand register.

Operation

These instructions:

1. Either:
 - Convert a value in a register from floating-point value to a 32-bit integer.
 - Convert from a 32-bit integer to floating-point value.
2. Place the result in a second register.

The floating-point to integer operation normally uses the Round towards Zero rounding mode, but can optionally use the rounding mode specified by the FPSCR.

The integer to floating-point operation uses the rounding mode specified by the FPSCR.

Restrictions

There are no restrictions.

Condition flags

These instructions do not change the flags.

3.11.5 VCVT between floating-point and fixed-point

Converts a value in a register from floating-point to and from fixed-point.

Syntax

```
VCVT{cond}.Td.F<32|64> <Sd/Dd>, <Sd/Dd>, #fbits
```

```
VCVT{cond}.F<32|64>.Td <Sd/Dd>, <Sd/Dd>, #fbits
```

Where:

cond Is an optional condition code. See [Conditional execution on page 68](#).

Td Is the data type for the fixed-point number. It must be one of:

- S16 signed 16-bit value.
- U16 unsigned 16-bit value.
- S32 signed 32-bit value.
- U32 unsigned 32-bit value.

<*Sd/Dd*> Is the destination register and the operand register.

fbits Is the number of fraction bits in the fixed-point number:

- If *Td* is S16 or U16, *fbits* must be in the range 0-16.
- If *Td* is S32 or U32, *fbits* must be in the range 1-32.

Operation

This instruction:

1. Either
 - Converts a value in a register from floating-point to fixed-point.
 - Converts a value in a register from fixed-point to floating-point.
2. Places the result in a second register.

The floating-point values are single-precision or double-precision.

The fixed-point value can be 16-bit or 32-bit. Conversions from fixed-point values take their operand from the low-order bits of the source register and ignore any remaining bits.

Signed conversions to fixed-point values sign-extend the result value to the destination register width.

Unsigned conversions to fixed-point values zero-extend the result value to the destination register width.

The floating-point to fixed-point operation uses the Round towards Zero rounding mode. The fixed-point to floating-point operation uses the Round to Nearest rounding mode.

Restrictions

There are no restrictions.

Condition flags

These instructions do not change the flags.

3.11.6 VCVTB, VCVTT

Converts between half-precision and single-precision or double-precision without intermediate rounding.

Syntax

$$\text{VCVT}\{y\}\{cond\}.\text{F}<32|64>.\text{F}16 <Sd/Dd>, Sm$$

$$\text{VCVT}\{y\}\{cond\}.\text{F}16.\text{F}<32|64> Sd, <Sm/Dm>$$

Where:

y Specifies which half of the operand register Sm or destination register Sd is used for the operand or destination:

- If y is B , then the bottom half, bits [15:0], of Sm or Sd is used.
- If y is T , then the top half, bits [31:16], of Sm or Sd is used.

$cond$ Is an optional condition code. See [Conditional execution on page 68](#).

$<Sd/Dd>$ Is the destination register.

$<Sm/Dm>$ Is the operand register.

Operation

This instruction with the $.\text{F}16.\text{F}<32|64>$ suffix:

1. Converts the half-precision value in the top or bottom half of a single-precision register to single-precision or double-precision value.
2. Writes the result to a single-precision or double-precision register.

This instruction with the $.\text{F}<32|64>.\text{F}16$ suffix:

1. Converts the value in a double-precision or single-precision register to half-precision value.
2. Writes the result into the top or bottom half of a single-precision register, preserving the other half of the target register.

Restrictions

There are no restrictions.

Condition flags

These instructions do not change the flags.

3.11.7 VDIV

Divides floating-point values.

Syntax

$$\text{VDIV}\{cond\}.\text{F}<32|64> \{<Sd/Dd>, \} <Sn/Dn>, <Sm/Dm>$$

Where:

$cond$ Is an optional condition code. See [Conditional execution on page 68](#).

$<Sd/Dd>$ Is the destination register.

$<Sn/Dn>, <Sm/Dm>$

Are the operand registers.

Operation

This instruction:

1. Divides one floating-point value by another floating-point value.
2. Writes the result to the floating-point destination register.

Restrictions

There are no restrictions.

Condition flags

These instructions do not change the flags.

3.11.8 VFMA, VFMS

Floating-point Fused Multiply Accumulate and Subtract.

Syntax

$VFMA\{cond\}.F<32|64>\{<Sd/Dd>, \} <Sn/Dn>, <Sm/Dm>$

$VFMS\{cond\}.F<32|64>\{<Sd/Dd>, \} <Sn/Dn>, <Sm/Dm>$

Where:

- cond* Is an optional condition code. See [Conditional execution on page 68](#).
- $<Sd/Dd>$ Is the destination register.
- $<Sn/Dn>, <Sm/Dm>$ Are the operand registers.

Operation

The VFMA instruction:

1. Multiplies the floating-point values in the operand registers.
2. Accumulates the results into the destination register.

The result of the multiply is not rounded before the accumulation.

The VFMS instruction:

1. Negates the first operand register.
2. Multiplies the floating-point values of the first and second operand registers.
3. Adds the products to the destination register.
4. Places the results in the destination register.

The result of the multiply is not rounded before the addition.

Restrictions

There are no restrictions.

Condition flags

These instructions do not change the flags.

3.11.9 VFNMA, VFNMS

Floating-point Fused Negate Multiply Accumulate and Subtract.

Syntax

VFNMA{*cond*}.F<32|64> {<*Sd*/*Dd*>,} <*Sn*/*Dn*>, <*Sm*/*Dm*>

VFNMS{*cond*}.F<32|64> {<*Sd*/*Dd*>,} <*Sn*/*Dn*>, <*Sm*/*Dm*>

Where:

cond Is an optional condition code. See [Conditional execution on page 68](#).

<*Sd*/*Dd*> Is the destination register.

<*Sn*/*Dn*>, <*Sm*/*Dm*>
Are the operand registers.

Operation

The VFNMA instruction:

1. Negates the first floating-point operand register.
2. Multiplies the first floating-point operand with second floating-point operand.
3. Adds the negation of the floating -point destination register to the product
4. Places the result into the destination register.

The result of the multiply is not rounded before the addition.

The VFNMS instruction:

1. Multiplies the first floating-point operand with second floating-point operand.
2. Adds the negation of the floating-point value in the destination register to the product.
3. Places the result in the destination register.

The result of the multiply is not rounded before the addition.

Restrictions

There are no restrictions.

Condition flags

These instructions do not change the flags.

3.11.10 VLDM

Floating-point Load Multiple.

Syntax

VLDM{*mode*}{*cond*}{*.size*} *Rn*{!}, *list*

Where:

mode Is the addressing mode:

<i>IA</i>	Increment after. The consecutive addresses start at the address specified in <i>Rn</i> .
<i>DB</i>	Decrement before. The consecutive addresses end just before the address specified in <i>Rn</i> .

cond Is an optional condition code. See [Conditional execution on page 68](#).

<i>size</i>	Is an optional data size specifier.
<i>Rn</i>	Is the base register. The SP can be used.
<i>!</i>	Is the command to the instruction to write a modified value back to <i>Rn</i> . This is required if <code>mode == DB</code> , and is optional if <code>mode == IA</code> .
<i>list</i>	Is the list of extension registers to be loaded, as a list of consecutively numbered doubleword or singleword registers, separated by commas and surrounded by brackets.

Operation

This instruction loads multiple extension registers from consecutive memory locations using an address from an Arm core register as the base address.

Restrictions

The restrictions are:

- If *size* is present, it must be equal to the size in bits, 32 or 64, of the registers in *list*.
- For the base address, the SP can be used. In the Arm instruction set, if *!* is not specified the PC can be used.
- *list* must contain at least one register. If it contains doubleword registers, it must not contain more than 16 registers.
- If using the Decrement Before addressing mode, the write back flag, *!*, must be appended to the base register specification.

Condition flags

These instructions do not change the flags.

Example

```
VLDMIA.F64 r1, {d3,d4,d5}
```

3.11.11 VLDR

Loads a single extension register from memory.

Syntax

```
VLDR{cond}{.F<32|64>} <sd/Dd>, [Rn{#imm}]
```

```
VLDR{cond}{.F<32|64>} <sd/Dd>, label
```

```
VLDR{cond}{.F<32|64>} <sd/Dd>, [PC, #imm]
```

Where:

<i>cond</i>	Is an optional condition code. See Conditional execution on page 68 .
<i>32, 64</i>	Are the optional data size specifiers.
<i>Dd</i>	Is the destination register for a doubleword load.
<i>Sd</i>	Is the destination register for a singleword load.
<i>Rn</i>	Is the base register. The SP can be used.
<i>imm</i>	Is the + or - immediate offset used to form the address. Permitted address values are multiples of 4 in the range 0 to 1020.
<i>label</i>	Is the label of the literal data item to be loaded.

Operation

This instruction loads a single extension register from memory, using a base address from an Arm core register, with an optional offset.

Restrictions

There are no restrictions.

Condition flags

These instructions do not change the flags.

3.11.12 VMLA, VMLS

Multiplies two floating-point values, and accumulates or subtracts the result.

Syntax

$VMLA\{cond\}.F<32|64> <Sd/Dd>, <Sn/Dn>, <Sm/Dm>$

$VMLS\{cond\}.F<32|64> <Sd/Dd>, <Sn/Dn>, <Sm/Dm>$

Where:

cond Is an optional condition code. See [Conditional execution on page 68](#).

$<Sd/Dd>$ Is the destination floating-point value.

$<Sn/Dn>, <Sm/Dm>$

Are the operand floating-point values.

Operation

The floating-point Multiply Accumulate instruction:

1. Multiplies two floating-point values.
2. Adds the results to the destination floating-point value.

The floating-point Multiply Subtract instruction:

1. Multiplies two floating-point values.
2. Subtracts the products from the destination floating-point value.
3. Places the results in the destination register.

Restrictions

There are no restrictions.

Condition flags

These instructions do not change the flags.

3.11.13 VMOV immediate

Moves floating-point Immediate.

Syntax

```
VMOV{cond}.F<32|64> <Sd/Dd>, #imm
```

Where:

cond Is an optional condition code. See [Conditional execution on page 68](#).
<Sd/Dd> Is the destination register.
imm Is a floating-point constant.

Operation

This instruction copies a constant value to a floating-point register.

Restrictions

There are no restrictions.

Condition flags

These instructions do not change the flags.

3.11.14 VMOV register

Copies the contents of one register to another.

Syntax

```
VMOV{cond}.F<32|64> <Sd/Dd>, <Sm|Dm>
```

Where:

cond Is an optional condition code. See [Conditional execution on page 68](#).
Dd Is the destination register, for a doubleword operation.
Dm Is the source register, for a doubleword operation.
Sd Is the destination register, for a singleword operation.
Sm Is the source register, for a singleword operation.

Operation

This instruction copies the contents of one floating-point register to another.

Restrictions

There are no restrictions.

Condition flags

These instructions do not change the flags.

3.11.15 VMOV scalar to Arm core register

Transfers one word of a doubleword floating-point register to an Arm core register.

Syntax

```
VMOV{cond} Rt, Dn[x]
```

Where:

<i>cond</i>	Is an optional condition code. See Conditional execution on page 68 .
<i>Rt</i>	Is the destination Arm core register.
<i>Dn</i>	Is the 64-bit doubleword register.
<i>x</i>	Specifies which half of the doubleword register to use: <ul style="list-style-type: none"> • If <i>x</i> is 0, use lower half of doubleword register • If <i>x</i> is 1, use upper half of doubleword register.

Operation

This instruction transfers one word from the upper or lower half of a doubleword floating-point register to an Arm core register.

Restrictions

Rt cannot be PC or SP.

Condition flags

These instructions do not change the flags.

3.11.16 VMOV Arm core register to single-precision

Transfers a single-precision register to and from an Arm core register.

Syntax

```
VMOV{cond} Sn, Rt
```

```
VMOV{cond} Rt, Sn
```

Where:

<i>cond</i>	Is an optional condition code. See Conditional execution on page 68 .
< <i>Sn</i> >	Is the single-precision floating-point register.
<i>Rt</i>	Is the Arm core register.

Operation

This instruction transfers:

- The contents of a single-precision register to an Arm core register.
- The contents of an Arm core register to a single-precision register.

Restrictions

Rt cannot be PC or SP.

Condition flags

These instructions do not change the flags.

3.11.17 VMOV two Arm core registers to two single-precision registers

Transfers two consecutively numbered single-precision registers to and from two Arm core registers.

Syntax

```
VMOV{cond} Sm, Sm1, Rt, Rt2
```

```
VMOV{cond} Rt, Rt2, Sm, Sm1
```

Where:

<i>cond</i>	Is an optional condition code. See Conditional execution on page 68 .
<i>Sm</i>	Is the first single-precision register.
<i>Sm1</i>	Is the second single-precision register. This is the next single-precision register after <i><Sm></i> .
<i>Rt</i>	Is the Arm core register that <i><Sm></i> is transferred to or from.
<i>Rt2</i>	Is the The Arm core register that <i><Sm1></i> is transferred to or from.

Operation

This instruction transfers:

- The contents of two consecutively numbered single-precision registers to two Arm core registers.
- The contents of two Arm core registers to a pair of single-precision registers.

Restrictions

The restrictions are:

- The floating-point registers must be contiguous, one after the other.
- The Arm core registers do not have to be contiguous.
- *Rt* cannot be PC or SP.

Condition flags

These instructions do not change the flags.

3.11.18 VMOV two Arm core registers and a double-precision register

Transfers two words from two Arm core registers to a doubleword register, or from a doubleword register to two Arm core registers.

Syntax

```
VMOV{cond} Dm, Rt, Rt2
```

```
VMOV{cond} Rt, Rt2, Dm
```

Where:

<i>cond</i>	Is an optional condition code. See Conditional execution on page 68 .
<i>Dm</i>	Is the double-precision register.
<i>Rt, Rt2</i>	Are the two Arm core registers.

Operation

This instruction:

- Transfers two words from two Arm core registers to a doubleword register.
- Transfers a doubleword register to two Arm core registers.

Restrictions

There are no restrictions.

Condition flags

These instructions do not change the flags.

3.11.19 VMOV Arm core register to scalar

Transfers one word to a floating-point register from an Arm core register.

Syntax

```
VMOV{cond}{.32} Dd[x], Rt
```

Where:

<i>cond</i>	Is an optional condition code. See Conditional execution on page 68 .
<i>32</i>	Is an optional data size specifier.
<i>Dd[x]</i>	Is the destination, where [x] defines which half of the doubleword is transferred, as follows: <ul style="list-style-type: none"> • If x is 0, the lower half is extracted. • If x is 1, the upper half is extracted.
<i>Rt</i>	Is the source Arm core register.

Operation

This instruction transfers one word to the upper or lower half of a doubleword floating-point register from an Arm core register.

Restrictions

Rt cannot be PC or SP.

Condition flags

These instructions do not change the flags.

3.11.20 VMRS

Moves to Arm core register from floating-point System register.

Syntax

```
VMRS{cond} Rt, FPSCR
```

```
VMRS{cond} APSR_nzcv, FPSCR
```

Where:

<i>cond</i>	Is an optional condition code. See Conditional execution on page 68 .
<i>Rt</i>	Is the destination Arm core register. This register can be R0-R14.

APSR_nzcv Transfer floating-point flags to the APSR flags.

Operation

This instruction performs one of the following actions:

- Copies the value of the FPSCR to a general-purpose register.
- Copies the value of the FPSCR flag bits to the APSR N, Z, C, and V flags.

Restrictions

Rt cannot be PC or SP.

Condition flags

These instructions optionally change the N, Z, C, and V flags.

3.11.21 VMSR

Moves to floating-point System register from Arm core register.

Syntax

VMSR{*cond*} *FPSCR*, *Rt*

Where:

cond Is an optional condition code. See [Conditional execution on page 68](#).

Rt Is the general-purpose register to be transferred to the FPSCR.

Operation

This instruction moves the value of a general-purpose register to the FPSCR. See [Floating-point status control register on page 236](#) for more information.

Restrictions

Rt cannot be PC or SP.

Condition flags

This instruction updates the FPSCR.

3.11.22 VMUL

Floating-point Multiply.

Syntax

VMUL{*cond*}.F<32|64> {<*Sd*/*Dd*>, } <*Sn*/*Dn*>, <*Sm*/*Dm*>

Where:

cond Is an optional condition code. See [Conditional execution on page 68](#).

<*Sd*/*Dd*> Is the destination floating-point value.

<*Sn*/*Dn*>, <*Sm*/*Dm*>
Are the operand floating-point values.

Operation

This instruction:

1. Multiplies two floating-point values.
2. Places the results in the destination register.

Restrictions

There are no restrictions.

Condition flags

These instructions do not change the flags.

3.11.23 VNEG

Floating-point Negate.

Syntax

VNEG{ *cond* }.F<32|64> <*Sd*/*Dd*>, <*Sm*/*Dm*>

Where:

- cond* Is an optional condition code. See [Conditional execution on page 68](#).
 <*Sd*/*Dd*> Is the destination floating-point value.
 <*Sm*/*Dm*> Is the operand floating-point value.

Operation

This instruction:

1. Negates a floating-point value.
2. Places the results in a second floating-point register.

The floating-point instruction inverts the sign bit.

Restrictions

There are no restrictions.

Condition flags

These instructions do not change the flags.

3.11.24 VNMLA, VNMLS, VNMUL

Floating-point multiply with negation followed by add or subtract.

Syntax

VNMLA{ *cond* }.F<32|64> <*Sd*/*Dd*>, <*Sn*/*Dn*>, <*Sm*/*Dm*>

VNMLS{ *cond* }.F<32|64> <*Sd*/*Dd*>, <*Sn*/*Dn*>, <*Sm*/*Dm*>

VNMUL{ *cond* }.F<32|64> {<*Sd*/*Dd*>, } <*Sn*/*Dn*>, <*Sm*/*Dm*>

Where:

- cond* Is an optional condition code. See [Conditional execution on page 68](#).
 <*Sd*/*Dd*> Is the destination floating-point register.

$\langle Sn/Dn \rangle$, $\langle Sm/Dm \rangle$ Are the operand floating-point registers.

Operation

The VNMLA instruction:

1. Multiplies two floating-point register values.
2. Adds the negation of the floating-point value in the destination register to the negation of the product.
3. Writes the result back to the destination register.

The VNMLS instruction:

1. Multiplies two floating-point register values.
2. Adds the negation of the floating-point value in the destination register to the product.
3. Writes the result back to the destination register.

The VNMUL instruction:

1. Multiplies together two floating-point register values.
2. Writes the negation of the result to the destination register.

Restrictions

There are no restrictions.

Condition flags

These instructions do not change the flags.

3.11.25 VPOP

Floating-point extension register Pop.

Syntax

`VPOP{cond}{.size} list`

Where:

<i>cond</i>	Is an optional condition code. See Conditional execution on page 68 .
<i>size</i>	Is an optional data size specifier. If present, it must be equal to the size in bits, 32 or 64, of the registers in <i>list</i> .
<i>list</i>	Is a list of extension registers to be loaded, as a list of consecutively numbered doubleword or singleword registers, separated by commas and surrounded by brackets.

Operation

This instruction loads multiple consecutive extension registers from the stack.

Restrictions

The list must contain at least one register, and not more than sixteen registers.

Condition flags

These instructions do not change the flags.

3.11.26 V PUSH

Floating-point extension register Push.

Syntax

```
V PUSH{cond}{.size} list
```

Where:

cond Is an optional condition code. See [Conditional execution on page 68](#).
size Is an optional data size specifier. If present, it must be equal to the size in bits, 32 or 64, of the registers in *list*.
list Is a list of the extension registers to be stored, as a list of consecutively numbered doubleword or singleword registers, separated by commas and surrounded by brackets.

Operation

This instruction stores multiple consecutive extension registers to the stack.

Restrictions

list must contain at least one register, and not more than sixteen.

Condition flags

These instructions do not change the flags.

3.11.27 V SQRT

Floating-point Square Root.

Syntax

```
V SQRT{cond}.F<32|64> <Sd/Dd>, <Sm/Dm>
```

Where:

cond Is an optional condition code. See [Conditional execution on page 68](#).
 <*Sd*/*Dd*> Is the destination floating-point value.
 <*Sm*/*Dm*> Is the operand floating-point value.

Operation

This instruction:

- Calculates the square root of the value in a floating-point register.
- Writes the result to another floating-point register.

Restrictions

There are no restrictions.

Condition flags

These instructions do not change the flags.

3.11.28 VSTM

Floating-point Store Multiple.

Syntax

```
VSTM{mode}{cond}{.size} Rn{!}, list
```

Where:

<i>mode</i>	Is the addressing mode: <ul style="list-style-type: none"> • <i>IA Increment After</i>. The consecutive addresses start at the address specified in <i>Rn</i>. This is the default and can be omitted. • <i>DB Decrement Before</i>. The consecutive addresses end just before the address specified in <i>Rn</i>.
<i>cond</i>	Is an optional condition code. See Conditional execution on page 68 .
<i>size</i>	Is an optional data size specifier. If present, it must be equal to the size in bits, 32 or 64, of the registers in <i>list</i> .
<i>Rn</i>	Is the base register. The SP can be used.
<i>!</i>	Is the function that causes the instruction to write a modified value back to <i>Rn</i> . Required if <code>mode == DB</code> .
<i>list</i>	Is a list of the extension registers to be stored, as a list of consecutively numbered doubleword or singleword registers, separated by commas and surrounded by brackets.

Operation

This instruction stores multiple extension registers to consecutive memory locations using a base address from an Arm core register.

Restrictions

The restrictions are:

- *list* must contain at least one register. If it contains doubleword registers it must not contain more than 16 registers.
- Use of the PC as *Rn* is deprecated.

Condition flags

These instructions do not change the flags.

3.11.29 VSTR

Floating-point Store.

Syntax

```
VSTR{cond}{.32} Sd, [Rn{, #imm}]
```

```
VSTR{cond}{.64} Dd, [Rn{, #imm}]
```

Where:

<i>cond</i>	Is an optional condition code. See Conditional execution on page 68 .
<i>32, 64</i>	Are the optional data size specifiers.
<i>Sd</i>	Is the source register for a singleword store.
<i>Dd</i>	Is the source register for a doubleword store.

Rn Is the base register. The SP can be used.
imm Is the + or - immediate offset used to form the address. Values are multiples of 4 in the range 0-1020. *imm* can be omitted, meaning an offset of +0.

Operation

This instruction stores a single extension register to memory, using an address from an Arm core register, with an optional offset, defined in *imm*:

Restrictions

The use of PC for *Rn* is deprecated.

Condition flags

These instructions do not change the flags.

3.11.30 VSUB

Floating-point Subtract.

Syntax

$VSUB\{cond\}.F<32|64>\{<Sd|Dd>, \} <Sn|Dn>, <Sm|Dm>$

Where:

cond Is an optional condition code. See [Conditional execution on page 68](#).

<Sd|Dd> Is the destination floating-point value.

<Sn|Dn>, <Sm|Dm>

Are the operand floating-point values.

Operation

This instruction:

1. Subtracts one floating-point value from another floating-point value.
2. Places the results in the destination floating-point register.

Restrictions

There are no restrictions.

Condition flags

These instructions do not change the flags.

3.11.31 VSEL

Provides an alternative to a pair of conditional `VMOV` instructions.

Encoding

`VSEL{cond}.F<32|64> <Sd|Dd>, <Sn|Dn>, <Sm|Dm>`

Where:

`cond` Is an optional condition code. See [Conditional execution on page 68](#). `VSEL` has a subset of the condition codes. The condition codes for `VSEL` are limited to `GE`, `GT`, `EQ` and `VS`, with the effect that `LT`, `LE`, `NE` and `VC` is achievable by exchanging the source operands.

`<Sd|Dd>` Is the destination single-precision or double-precision floating-point value.

`<Sn|Dn>`, `<Sm|Dm>`

Are the operand single-precision or double-precision floating-point values.

Operation

Depending on the result of the condition code, this instruction moves either:

- `<Sn|Dn>` source register to the destination register.
- `<Sm|Dm>` source register to the destination register.

Restrictions

The `VSEL` instruction must not occur inside an IT block.

Condition flags

These instructions do not change the flags.

3.11.32 VMAXNM, VMINNM

Return the minimum or the maximum of two floating-point numbers with NaN handling as specified by IEEE754-2008.

Encoding

`VMAXNM.F<32|64> <Sd|Dd>, <Sn|Dn>, <Sm|Dm>`

`VMINNM.F<32|64> <Sd|Dd>, <Sn|Dn>, <Sm|Dm>`

Where:

`<Sd|Dd>` Is the destination single-precision or double-precision floating-point value.

`<Sn|Dn>`, `<Sm|Dm>`

Are the operand single-precision or double-precision floating-point values.

Operation

The `VMAXNM` instruction compares two source registers, and moves the largest to the destination register.

The `VMINNM` instruction compares two source registers, and moves the lowest to the destination register.

Restrictions

There are no restrictions.

Condition flags

These instructions do not change the flags.

3.11.33 VCVTA, VCVTN, VCVTP, VCVTM

Floating-point to integer conversion with directed rounding.

Syntax

$VCVT<rmode>.S32.F<32|64> <Sd>, <Sm|Dm>$

$VCVT<rmode>.U32.F<32|64> <Sd>, <Sm|Dm>$

Where:

$<Sd|Dd>$ Is the destination single-precision or double-precision floating-point value.

$<Sn|Dn>, <Sm|Dm>$

Are the operand single-precision or double-precision floating-point values.

$<rmode>$ Is one of:

- | | |
|---|-------------------------------|
| A | Round to nearest ties away. |
| M | Round to nearest even. |
| N | Round towards plus infinity. |
| P | Round towards minus infinity. |

Operation

These instructions:

1. Read the source register.
2. Convert to integer with directed rounding.
3. Write to the destination register.

Restrictions

There are no restrictions.

Condition flags

These instructions do not change the flags.

3.11.34 VRINTR, VRINTX

Round a floating-point value to an integer in floating-point format.

Encoding

$VRINT\{R,X\}\{cond\}.F<32|64> <Sd|Dd>, <Sm|Dm>$

Where:

$cond$ Is an optional condition code. See [Conditional execution on page 68](#).

$<Sd|Dd>$ Is the destination floating-point value.

$<Sm|Dm>$ Are the operand floating-point values.

Operation

These instructions:

1. Read the source register.
2. Round to the nearest integer value in floating-point format using the rounding mode specified by the FPSCR.
3. Write the result to the destination register.
4. For the VRINTZX instruction only. Generate a floating-point exception if the result is not exact.

Restrictions

There are no restrictions.

Condition flags

These instructions do not change the flags.

3.11.35 VRINTA, VRINTN, VRINTP, VRINTM, VRINTZ

Round a floating-point value to an integer in floating-point format using directed rounding.

Encoding

$VRINT\langle rmode \rangle.F\langle 32 | 64 \rangle \langle Sd | Dd \rangle, \langle Sm | Dm \rangle$

Where:

$\langle Sd | Dd \rangle$ Is the destination single-precision or double-precision floating-point value.

$\langle Sn | Dn \rangle, \langle Sm | Dm \rangle$

Are the operand single-precision or double-precision floating-point values.

$\langle rmode \rangle$ Is one of:

A	Round to nearest ties away.
M	Round to Nearest Even.
N	Round towards Plus Infinity.
P	Round towards Minus Infinity.
Z	Round towards Zero.

Operation

These instructions:

1. Read the source register.
2. Round to the nearest integer value with a directed rounding mode specified by the instruction.
3. Write the result to the destination register.

Restrictions

These instructions cannot be conditional. These instructions cannot generate an inexact exception even if the result is not exact.

Condition flags

These instructions do not change the flags.

3.12 Miscellaneous instructions

[Table 38](#) shows the remaining Cortex[®]-M7 instructions:

Table 38. Miscellaneous instructions

Mnemonic	Brief description	See
BKPT	Breakpoint	BKPT on page 175
CPSID	Change Processor State, Disable Interrupts	CPS on page 176
CPSIE	Change Processor State, Enable Interrupts	CPS on page 176
DMB	Data Memory Barrier	DMB on page 177
DSB	Data Synchronization Barrier	DSB on page 177
ISB	Instruction Synchronization Barrier	ISB on page 178
MRS	Move from special register to register	MRS on page 178
MSR	Move from register to special register	MSR on page 179
NOP	No Operation	NOP on page 180
SEV	Send Event	SEV on page 180
SVC	Supervisor Call	SVC on page 181
WFE	Wait For Event	WFE on page 181
WFI	Wait For Interrupt	WFI on page 182

3.12.1 BKPT

Breakpoint.

Syntax

BKPT #*imm*

Where:

imm Is an expression evaluating to an integer in the range 0-255 (8-bit value).

Operation

The BKPT instruction causes the processor to enter Debug state. Debug tools can use this to investigate system state when the instruction at a particular address is reached.

imm is ignored by the processor. If required, a debugger can use it to store additional information about the breakpoint.

The BKPT instruction can be placed inside an IT block, but it executes unconditionally, unaffected by the condition specified by the IT instruction.

Condition flags

This instruction does not change the flags.

Examples

```
BKPT #0x3 ; Breakpoint with immediate value set to 0x3 (debugger can
; extract the immediate value by locating it using the PC)
```

Arm does not recommend the use of the BKPT instruction with an immediate value set to 0xAB for any purpose other than Semi-hosting.

3.12.2 CPS

Change Processor State.

Syntax

CPSeffect iflags

Where:

<i>effect</i>	Is one of:
IE	Clears the special purpose register.
ID	Sets the special purpose register.
<i>iflags</i>	Is a sequence of one or more flags:
i	Set or clear PRIMASK.
f	Set or clear FAULTMASK.

Operation

CPS changes the PRIMASK and FAULTMASK special register values. See [Exception mask registers on page 25](#) for more information about these registers.

Restrictions

The restrictions are:

- Use CPS only from privileged software. It has no effect if used in unprivileged software.
- CPS cannot be conditional and so must not be used inside an IT block.

Condition flags

This instruction does not change the condition flags.

Examples

```
CPSID i ; Disable interrupts and configurable fault handlers (set
; PRIMASK)
CPSID f ; Disable interrupts and all fault handlers (set FAULTMASK)
CPSIE i ; Enable interrupts and configurable fault handlers (clear
; PRIMASK)
CPSIE f ; Enable interrupts and fault handlers (clear FAULTMASK)
```

3.12.3 DMB

Data Memory Barrier.

Syntax

`DMB{cond}`

Where:

`cond` Is an optional condition code. See [Conditional execution on page 68](#).

Operation

DMB acts as a data memory barrier. It ensures that all explicit memory accesses that appear, in program order, before the DMB instruction are completed before any explicit memory accesses that appear, in program order, after the DMB instruction. DMB does not affect the ordering or execution of instructions that do not access memory.

Condition flags

This instruction does not change the flags.

Examples

```
DMB ; Data Memory Barrier
```

3.12.4 DSB

Data Synchronization Barrier.

Syntax

`DSB{cond}`

Where:

`cond` Is an optional condition code. See [Conditional execution on page 68](#).

Operation

DSB acts as a special data synchronization memory barrier. Instructions that come after the DSB, in program order, do not execute until the DSB instruction completes. The DSB instruction completes when all explicit memory accesses before it complete.

Condition flags

This instruction does not change the flags.

Examples

```
DSB ; Data Synchronisation Barrier
```

3.12.5 ISB

Instruction Synchronization Barrier.

Syntax

`ISB{cond}`

Where:

cond is an optional condition code. See [Conditional execution on page 68](#).

Operation

ISB acts as an instruction synchronization barrier. It flushes the pipeline of the processor, so that all instructions following the ISB are fetched from cache or memory again, after the ISB instruction has been completed.

Condition flags

This instruction does not change the flags.

Examples

```
ISB ; Instruction Synchronisation Barrier
```

3.12.6 MRS

Move the contents of a special register to a general-purpose register.

Syntax

`MRS{cond} Rd, spec_reg`

Where:

cond is an optional condition code. See [Conditional execution on page 68](#).

Rd is the destination register.

spec_reg Can be any of: APSR, IPSR, EPSR, IEPSR, IAPSR, EAPSR, PSR, MSP, PSP, PRIMASK, BASEPRI, BASEPRI_MAX, FAULTMASK, or CONTROL.

All the EPSR and IPSR fields are zero when read by the MRS instruction.

Operation

Use MRS in combination with MSR as part of a read-modify-write sequence for updating a PSR, for example to clear the Q flag.

In process swap code, the programmers model state of the process being swapped out must be saved, including relevant PSR contents. Similarly, the state of the process being swapped in must also be restored. These operations use MRS in the state-saving instruction sequence and MSR in the state-restoring instruction sequence.

BASEPRI_MAX is an alias of BASEPRI when used with the MRS instruction.

See [MSR on page 179](#).

Restrictions

Rd must not be SP and must not be PC.

Condition flags

This instruction does not change the flags.

Examples

```
MRS R0, PRIMASK ; Read PRIMASK value and write it to R0
```

3.12.7 MSR

Move the contents of a general-purpose register into the specified special register.

Syntax

```
MSR{cond} spec_reg, Rn
```

Where:

cond Is an optional condition code. See [Conditional execution on page 68](#).

Rn Is the source register.

spec_reg Can be any of: APSR_nzcvq, APSR_g, APSR_nzcvqg, MSP, PSP, PRIMASK, BASEPRI, BASEPRI_MAX, FAULTMASK, or CONTROL.

APSR can be used to refer to APSR_nzcvq.

Operation

The register access operation in MSR depends on the privilege level. Unprivileged software can only access the APSR, see [Table 4 on page 23](#). Privileged software can access all special registers.

In unprivileged software writes to unallocated or execution state bits in the PSR are ignored.

When writing to BASEPRI_MAX, the instruction writes to BASEPRI only if either:

- *Rn* is non-zero and the current BASEPRI value is 0.
- *Rn* is non-zero and less than the current BASEPRI value.

See [MRS on page 178](#).

Restrictions

Rn must not be SP and must not be PC.

Condition flags

This instruction updates the flags explicitly based on the value in *Rn*.

Examples

```
MSR CONTROL, R1 ; Read R1 value and write it to the CONTROL register
```

3.12.8 NOP

No Operation.

Syntax

`NOP{cond}`

Where:

cond Is an optional condition code. See [Conditional execution on page 68](#).

Operation

NOP does nothing. NOP is not necessarily a time-consuming NOP. The processor might remove it from the pipeline before it reaches the execution stage.

Use NOP for padding, for example to place the following instruction on a 64-bit boundary.

Condition flags

This instruction does not change the flags.

Examples

```
NOP ; No operation
```

3.12.9 SEV

Send Event.

Syntax

`SEV{cond}`

Where:

cond Is an optional condition code. See [Conditional execution on page 68](#).

Operation

SEV is a hint instruction that causes an event to be signaled to all processors within a multiprocessor system. It also sets the local event register to 1, see [Power management on page 50](#).

Condition flags

This instruction does not change the flags.

Examples

```
SEV ; Send Event
```

3.12.10 SVC

Supervisor Call.

Syntax

```
SVC{ cond } #imm
```

Where:

cond Is an optional condition code. See [Conditional execution on page 68](#).

imm Is an expression evaluating to an integer in the range 0-255 (8-bit value).

Operation

The SVC instruction causes the SVC exception.

imm is ignored by the processor. If required, it can be retrieved by the exception handler to determine what service is being requested.

Condition flags

This instruction does not change the flags.

Examples

```
SVC #0x32 ; Supervisor Call (SVC handler can extract the immediate
           ; value by locating it through the stacked PC)
```

3.12.11 WFE

Wait For Event.

Syntax

```
WFE{ cond }
```

Where:

cond Is an optional condition code. See [Conditional execution on page 68](#).

Operation

WFE is a hint instruction.

If the event register is 0, WFE suspends execution until one of the following events occurs:

- An exception, unless masked by the exception mask registers or the current priority level.
- An exception enters the Pending state, if SEVONPEND in the System Control register is set.
- A Debug Entry request, if Debug is enabled.
- An event signaled by a peripheral or another processor in a multiprocessor system using the SEV instruction.

If the event register is 1, WFE clears it to 0 and returns immediately.

For more information see [Power management on page 50](#).

Condition flags

This instruction does not change the flags.

Examples

```
WFE ; Wait for event
```

3.12.12 WFI

Wait for Interrupt.

Syntax

```
WFI{cond}
```

Where:

cond Is an optional condition code. See [Conditional execution on page 68](#).

Operation

WFI is a hint instruction that suspends execution until one of the following events occurs:

- A non-masked interrupt occurs and is taken.
- An interrupt masked by PRIMASK becomes pending.
- A Debug Entry request.

Condition flags

This instruction does not change the flags.

Examples

```
WFI ; Wait for interrupt
```

4 Cortex-M7 peripherals

4.1 About the Cortex-M7 peripherals

The address map of the *Private peripheral bus* (PPB) is:

Table 39. Core peripheral register regions

Address	Core peripheral	Description
0xE000E008-0xE000E00F	System control block	Table 50 on page 192
0xE000E010-0xE000E01F	System timer	Table 71 on page 213
0xE000E100-0xE000E4EF	Nested Vectored Interrupt Controller	Table 40 on page 184
0xE000ED00-0xE000ED3F	System control block	Table 50 on page 192
0xE000ED78- 0xE000ED84	Processor features	Table 77 on page 217
0xE000ED90-0xE000EDB8	Memory Protection Unit	Table 84 on page 222
0xE000EF00-0xE000EF03	Nested Vectored Interrupt Controller	Table 40 on page 184
0xE000EF30-0xE000EF44	Floating-Point Unit	Table 94 on page 233
0xE000EF50-0xE000EF78	Cache maintenance operations	Table 100 on page 240
0xE000EF90-0xE000EFA8	Access control	Table 104 on page 245

In the register descriptions:

- the register *type* is described as follows:
 - RW** Read and write.
 - RO** Read-only.
 - WO** Write-only.
 - the *required privilege* gives the privilege level required to access the register, as follows:
 - Privileged**
Only privileged software can access the register.
 - Unprivileged**
Both unprivileged and privileged software can access the register.
- Attempting to access a privileged register from unprivileged software results in a BusFault.

4.2 Nested Vectored Interrupt Controller

This section describes the NVIC and the registers it uses. The NVIC supports:

- 1 to 240 interrupts.
- A programmable priority level of 0-255 for each interrupt. A higher level corresponds to a lower priority, so level 0 is the highest interrupt priority.
- Level and pulse detection of interrupt signals.
- Dynamic reprioritization of interrupts.
- Grouping of priority values into group priority and subpriority fields.
- Interrupt tail-chaining.
- An external *Non Maskable Interrupt* (NMI)

The processor automatically stacks its state on exception entry and unstacks this state on exception exit, with no instruction overhead. This provides low latency exception handling. The hardware implementation of the NVIC registers is:

Table 40. NVIC register summary

Address	Name	Type	Required privilege	Reset value	Description
0xE00E100-0xE00E11C	NVIC_ISER0-NVIC_ISER7	RW	Privileged	0x00000000	<i>Interrupt set-enable registers on page 185</i>
0xE00E180-0xE00E19C	NVIC_ICER0-NVIC_ICER7	RW	Privileged	0x00000000	<i>Interrupt clear-enable registers on page 186</i>
0xE00E200-0xE00E21C	NVIC_ISPR0-NVIC_ISPR7	RW	Privileged	0x00000000	<i>Interrupt set-pending registers on page 186</i>
0xE00E280-0xE00E29C	NVIC_ICPR0-NVIC_ICPR7	RW	Privileged	0x00000000	<i>Interrupt clear-pending registers on page 187</i>
0xE00E300-0xE00E31C	NVIC_IABR0-NVIC_IABR7	RW	Privileged	0x00000000	<i>Interrupt active bit registers on page 188</i>
0xE00E400-0xE00E4EF	NVIC_IPR0-NVIC_IPR59	RW	Privileged	0x00000000	<i>Interrupt priority registers on page 188</i>
0xE00EF00	STIR	WO	Configurable ⁽¹⁾	0x00000000	<i>Software trigger interrupt register on page 189</i>

1. See the register description for more information.

4.2.1 Accessing the Cortex[®]-M7 NVIC registers using CMSIS

CMSIS functions enable the software portability between different Cortex[®]-M profile processors. To access the NVIC registers when using CMSIS, use the following functions:

Table 41. CMSIS access NVIC functions

CMSIS function	Description
<code>void NVIC_EnableIRQ (IRQn_Type IRQn)⁽¹⁾</code>	Enables an interrupt or exception.
<code>void NVIC_DisableIRQ (IRQn_Type IRQn)⁽¹⁾</code>	Disables an interrupt or exception.
<code>void NVIC_SetPendingIRQ (IRQn_Type IRQn)⁽¹⁾</code>	Sets the pending status of interrupt or exception to 1.
<code>void NVIC_ClearPendingIRQ (IRQn_Type IRQn)⁽¹⁾</code>	Clears the pending status of interrupt or exception to 0.
<code>uint32_t NVIC_GetPendingIRQ (IRQn_Type IRQn)⁽¹⁾</code>	Reads the pending status of interrupt or exception. This function returns non-zero value if the pending status is set to 1.
<code>void NVIC_SetPriority (IRQn_Type IRQn, uint32_t priority)⁽¹⁾</code>	Sets the priority of an interrupt or exception with configurable priority level to 1.
<code>uint32_t NVIC_GetPriority (IRQn_Type IRQn)⁽¹⁾</code>	Reads the priority of an interrupt or exception with configurable priority level. This function return the current priority level.

1. The input parameter IRQn is the IRQ number, see [Table 19 on page 40](#) for more information.

4.2.2 Interrupt set-enable registers

The NVIC_ISER0-NVIC_ISER7 registers enable interrupts, and show which interrupts are enabled. See the register summary in [Table 40 on page 184](#) for the register attributes.

The bit assignments are:

Figure 17. ISER bit assignments

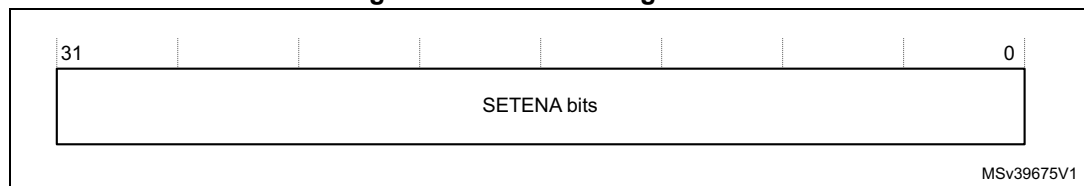

Table 42. ISER bit assignments

Bits	Name	Function
[31:0]	SETENA	Interrupt set-enable bits. Write: 0: No effect. 1: Enable interrupt. Read: 0: Interrupt disabled. 1: Interrupt enabled.

If a pending interrupt is enabled, the NVIC activates the interrupt based on its priority. If an interrupt is not enabled, asserting its interrupt signal changes the interrupt state to pending, but the NVIC never activates the interrupt, regardless of its priority.

4.2.3 Interrupt clear-enable registers

The NVIC_ICER0-NVIC_ICER7 registers disable interrupts, and show which interrupts are enabled. See the register summary in [Table 40 on page 184](#) for the register attributes.

The bit assignments are:

Figure 18. ICER bit assignment

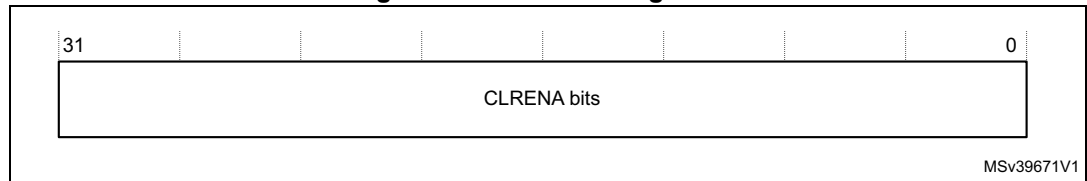

Table 43. ICER bit assignments

Bits	Name	Function
[31:0]	CLRENA	Interrupt clear-enable bits. Write: 0: No effect. 1: Disable interrupt. Read: 0: Interrupt disabled. 1: Interrupt enabled.

4.2.4 Interrupt set-pending registers

The NVIC_ISPR0-NVIC_ISPR7 registers force interrupts into the pending state, and show which interrupts are pending. See the register summary in [Table 40 on page 184](#) for the register attributes.

The bit assignments are:

Figure 19. ISPR bit assignments

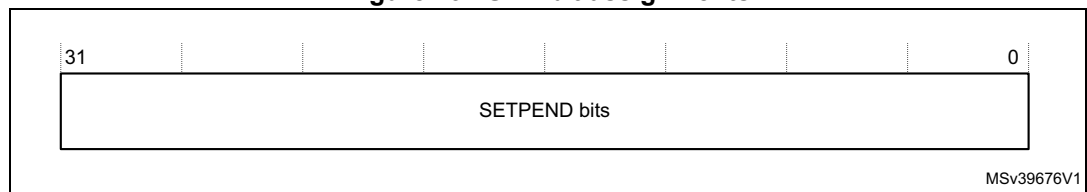

Table 44. ISPR bit assignments

Bits	Name	Function
[31:0]	SETPEND	Interrupt set-pending bits. Write: 0: No effect. 1: Changes interrupt state to pending. Read: 0: Interrupt is not pending. 1: Interrupt is pending.

Writing 1 to the ISPR bit corresponding to:

- An interrupt that is pending has no effect.
- A disabled interrupt sets the state of that interrupt to pending.

4.2.5 Interrupt clear-pending registers

The NVIC_ICPR0-NCVIC_ICPR7 registers remove the pending state from interrupts, and show which interrupts are pending. See the register summary in [Table 40 on page 184](#) for the register attributes.

The bit assignments are:

Figure 20. ICPR bit assignments

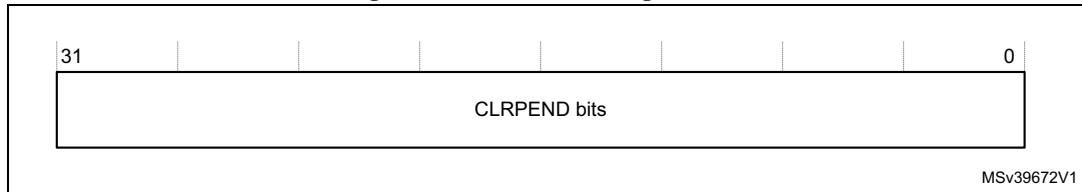

Table 45. ICPR bit assignments

Bits	Name	Function
[31:0]	CLRPEND	Interrupt clear-pending bits. Write: 0: No effect. 1: Removes pending state an interrupt. Read: 0: Interrupt is not pending. 1: Interrupt is pending.

Writing 1 to an ICPR bit does not affect the active state of the corresponding interrupt.

4.2.6 Interrupt active bit registers

The NVIC_IABR0-NVIC_IABR7 registers indicate which interrupts are active. See the register summary in [Table 40 on page 184](#) for the register attributes.

The bit assignments are:

Figure 21. IABR bit assignments

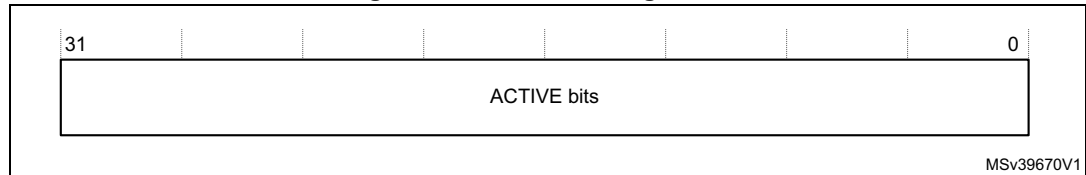

Table 46. IABR bit assignments

Bits	Name	Function
[31:0]	ACTIVE	Interrupt active flags: 0: Interrupt not active. 1: Interrupt active.

A bit is read as one if the status of the corresponding interrupt is active or active and pending.

4.2.7 Interrupt priority registers

The NVIC_IPR0-NVIC_IPR59 registers provide an 8-bit priority field for each interrupt. These registers are byte-accessible. See the register summary in [Table 40 on page 184](#) for their attributes. Each register holds four priority fields as shown:

Figure 22. IPR bit assignments

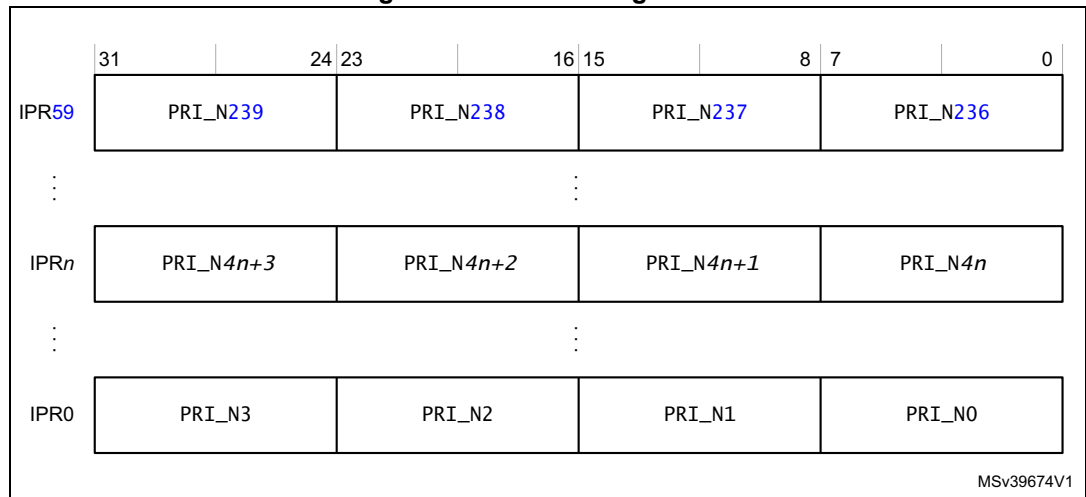

Table 47. IPR bit assignments

Bits	Name	Function
[31:24]	Priority, byte offset 3	Each priority field holds a priority value, 0-255. The lower the value, the greater the priority of the corresponding interrupt. The processor implements only bits[7:n] of each field, bits[n-1:0] read as zero and ignore writes.
[23:16]	Priority, byte offset 2	
[15:8]	Priority, byte offset 1	
[7:0]	Priority, byte offset 0	

See [Accessing the Cortex®-M7 NVIC registers using CMSIS on page 185](#) for more information about the access to the interrupt priority array, which provides the software view of the interrupt priorities.

Find the IPR number and byte offset for interrupt *m* as follows:

- the corresponding IPR number, see [Table 46 on page 188](#) *n* is given by $n = m \text{ DIV } 4$
- the byte offset of the required Priority field in this register is $m \text{ MOD } 4$, where:
 - Byte offset 0 refers to register bits[7:0].
 - Byte offset 1 refers to register bits[15:8].
 - Byte offset 2 refers to register bits[23:16].
 - Byte offset 3 refers to register bits[31:24].

4.2.8 Software trigger interrupt register

Write to the STIR to generate an interrupt from software. See the register summary in [Table 40 on page 184](#) for the STIR attributes.

When the USERSETMPEND bit in the SCR is set to 1, unprivileged software can access the STIR, see [System control register on page 199](#).

Only privileged software can enable unprivileged access to the STIR.

The bit assignments are:

Figure 23. STIR bit assignments

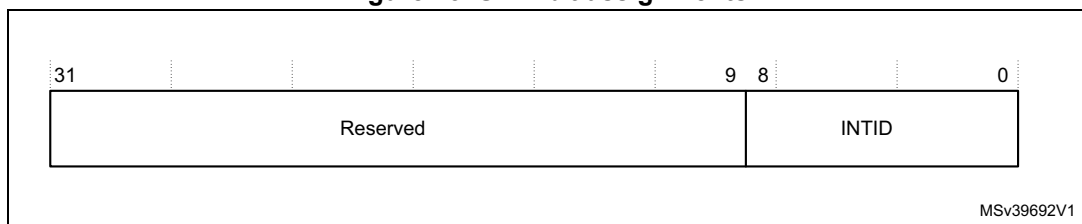

Table 48. STIR bit assignments

Bits	Field	Function
[31:9]	-	Reserved.
[8:0]	INTID	Interrupt ID of the interrupt to trigger, in the range 0-239. For example, a value of 0×03 specifies interrupt IRQ3.

4.2.9 Level-sensitive and pulse interrupts

The processor supports both level-sensitive and pulse interrupts. The pulse interrupts are also described as edge-triggered interrupts.

A level-sensitive interrupt is held asserted until the peripheral deasserts the interrupt signal. Typically this happens because the ISR accesses the peripheral, causing it to clear the interrupt request. A pulse interrupt is an interrupt signal sampled synchronously on the rising edge of the processor clock. To ensure the NVIC detects the interrupt, the peripheral must assert the interrupt signal for at least one clock cycle, during which the NVIC detects the pulse and latches the interrupt.

When the processor enters the ISR, it automatically removes the pending state from the interrupt, see [Hardware and software control of interrupts on page 190](#). For a level-sensitive interrupt, if the signal is not deasserted before the processor returns from the ISR, the interrupt becomes pending again, and the processor must execute its ISR again. This means that the peripheral can hold the interrupt signal asserted until it no longer requires servicing.

Hardware and software control of interrupts

- The Cortex[®]-M7 latches all interrupts. A peripheral interrupt becomes pending for one of the following reasons:
 - The NVIC detects that the interrupt signal is HIGH and the interrupt is not active.
 - The NVIC detects a rising edge on the interrupt signal.
 - Software writes to the corresponding interrupt set-pending register bit, see [Interrupt set-pending registers on page 186](#), or to the STIR to make an interrupt pending, see [Software trigger interrupt register on page 189](#).

A pending interrupt remains pending until one of the following:

- The processor enters the ISR for the interrupt. This changes the state of the interrupt from pending to active. Then:
 - For a level-sensitive interrupt, when the processor returns from the ISR, the NVIC samples the interrupt signal. If the signal is asserted, the state of the interrupt changes to pending, which might cause the processor to immediately re-enter the ISR. Otherwise, the state of the interrupt changes to inactive.
 - For a pulse interrupt, the NVIC continues to monitor the interrupt signal, and if this is pulsed the state of the interrupt changes to pending and active. In this case, when the processor returns from the ISR the state of the interrupt changes to pending, which might cause the processor to immediately re-enter the ISR.
 - If the interrupt signal is not pulsed while the processor is in the ISR, when the processor returns from the ISR the state of the interrupt changes to inactive.
- The software writes to the corresponding interrupt clear-pending register bit.

For a level-sensitive interrupt, if the interrupt signal is still asserted, the state of the interrupt does not change. Otherwise, the state of the interrupt changes to inactive.

For a pulse interrupt, the state of the interrupt changes to:

 - Inactive, if the state was pending.
 - Active, if the state was active and pending.

4.2.10 NVIC design hints and tips

Ensure that the software uses correctly aligned register accesses. The processor does not support unaligned accesses to NVIC registers. See the individual register descriptions for the supported access sizes.

An interrupt can enter pending state even if it is disabled. Disabling an interrupt only prevents the processor from taking that interrupt.

Before programming VTOR to relocate the vector table, ensure the vector table entries of the new vector table are set up for fault handlers, NMI, and all enabled exception-like interrupts. For more information see [Vector table offset register on page 197](#).

NVIC programming hints

The software uses the CPSIE I and CPSID I instructions to enable and disable interrupts. The CMSIS provides the following intrinsic functions for these instructions:

```
void __disable_irq(void) // Disable Interrupts
void __enable_irq(void) // Enable Interrupts
```

In addition, the CMSIS provides a number of functions for NVIC control, including:

Table 49. CMSIS functions for NVIC control

CMSIS interrupt control function	Description
<code>void NVIC_SetPriorityGrouping(uint32_t priority_grouping)</code>	Set the priority grouping
<code>void NVIC_EnableIRQ(IRQn_t IRQn)</code>	Enable IRQn
<code>void NVIC_DisableIRQ(IRQn_t IRQn)</code>	Disable IRQn
<code>uint32_t NVIC_GetPendingIRQ (IRQn_t IRQn)</code>	Return true (IRQ-Number) if IRQn is pending
<code>void NVIC_SetPendingIRQ (IRQn_t IRQn)</code>	Set IRQn pending
<code>void NVIC_ClearPendingIRQ (IRQn_t IRQn)</code>	Clear IRQn pending status
<code>uint32_t NVIC_GetActive (IRQn_t IRQn)</code>	Return the IRQ number of the active interrupt
<code>void NVIC_SetPriority (IRQn_t IRQn, uint32_t priority)</code>	Set priority for IRQn
<code>uint32_t NVIC_GetPriority (IRQn_t IRQn)</code>	Read priority of IRQn

The input parameter IRQn is the IRQ number, see [Table 19 on page 40](#). For more information about these functions see the CMSIS documentation.

4.3 System control block

The *System Control Block* (SCB) provides system implementation information, and system control. This includes configuration, control, and reporting of the system exceptions. The system control block registers are:

Table 50. Summary of the system control block registers

Address	Name	Type	Required privilege	Reset value	Description
0xE000E008	ACTLR	RW	Privileged	0x00000000	Auxiliary control register on page 193
0xE000ED00	CPUID	RO	Privileged	0x410FC270	CPUID base register on page 194
0xE000ED04	ICSR	RW ⁽¹⁾	Privileged	0x00000000	Interrupt control and state register on page 194
0xE000ED08	VTOR	RW	Privileged	Unknown	Vector table offset register on page 197
0xE000ED0C	AIRCR	RW ⁽¹⁾	Privileged	0xFA050000	Application interrupt and reset control register on page 197
0xE000ED10	SCR	RW	Privileged	0x00000000	System control register on page 199
0xE000ED14	CCR	RW	Privileged	0x00000200	Configuration and control register on page 200
0xE000ED18	SHPR1	RW	Privileged	0x00000000	System handler priority register 1 on page 202
0xE000ED1C	SHPR2	RW	Privileged	0x00000000	System handler priority register 2 on page 203
0xE000ED20	SHPR3	RW	Privileged	0x00000000	System handler priority register 3 on page 203
0xE000ED24	SHCRS	RW	Privileged	0x00000000	System handler control and state register on page 204
0xE000ED28	CFSR	RW	Privileged	0x00000000	Configurable fault status register on page 205
0xE000ED28	MMSR ⁽²⁾	RW	Privileged	0x00	MemManage fault address register on page 211
0xE000ED29	BFSR ⁽²⁾	RW	Privileged	0x00	BusFault status register on page 207
0xE000ED2A	UFSR ⁽²⁾	RW	Privileged	0x0000	Auxiliary control register on page 193
0xE000ED2C	HFSR	RW	Privileged	0x00000000	HardFault status register on page 210
0xE000ED34	MMAR	RW	Privileged	Unknown	MemManage fault address register on page 211
0xE000ED38	BFAR	RW	Privileged	Unknown	BusFault address register on page 212
0xE000ED3C	AFSR	RAZ/WI	Privileged	-	Auxiliary Fault Status register not implemented

1. See the register description for more information.

2. A subregister of the CFSR.

4.3.1 Auxiliary control register

The ACTLR provides disable bits for the following processor functions:

- FPU exception outputs.
- Dual-issue functionality.
- Flushing of the trace output from the ITM and DWT.
- Dynamic read allocate mode.

By default this register is set to provide optimum performance from the Cortex[®]-M7 processor, and does not normally require modification.

See the register summary in [Table 50 on page 192](#) for the ACTLR attributes. The bit assignments are:

Figure 24. ACTLR bit assignments

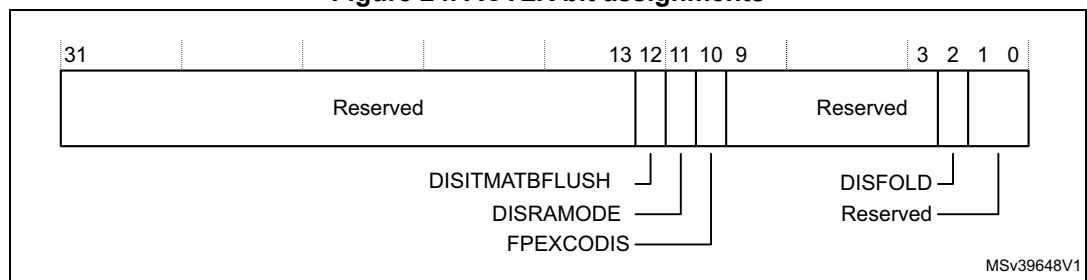

Table 51. ACTLR bit assignments

Bits	Name	Function
[31:13]	-	Reserved
[12]	DISITMATBFLUSH	Disables ITM and DWT ATB flush: 0: Normal operation. 1: ITM and DWT ATB flush disabled.
[11]	DISRAMODE	Disables dynamic read allocate mode for Write-Back Write-Allocate memory regions: 0: Normal operation. 1: Dynamic read allocate mode disabled.
[10]	FPEXCODIS	Disables FPU exception outputs: 0: Normal operation. 1: FPU exception outputs are disabled.
[9:3]	-	Reserved.
[2]	DISFOLD	Disables dual-issue functionality: 0: Normal operation. 1: Dual-issue functionality is disabled. Setting this bit decreases performance.
[1:0]	-	Reserved.

4.3.2 CPUID base register

The CPUID register contains the processor part number, version, and implementation information. See the register summary in [Table 50 on page 192](#) for its attributes. The bit assignments are:

Figure 25. CPUID bit assignments

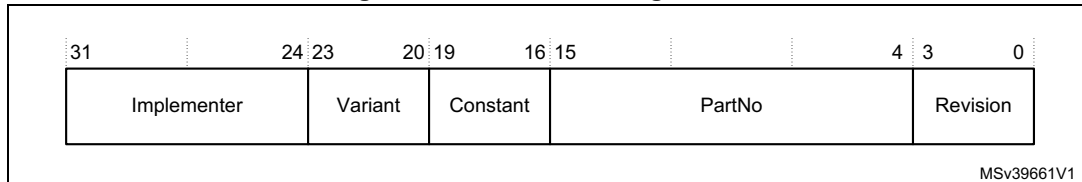

Table 52. CPUID bit assignments

Bits	Name	Function
[31:24]	Implementer	Implementer code: 0x41 Arm
[23:20]	Variant	Variant number, the r value in the <i>rnpn</i> product revision identifier: 0x0 Revision 0
[19:16]	Constant	Reads as 0xF
[15:4]	PartNo	Part number of the processor: 0xC27: Cortex [®] -M7
[3:0]	Revision	Revision number, the p value in the <i>rnpn</i> product revision identifier: 0x0: Patch 0

4.3.3 Interrupt control and state register

The ICSR:

- provides:
 - A set-pending bit for the *Non Maskable Interrupt* (NMI) exception.
 - Set-pending and clear-pending bits for the PendSV and SysTick exceptions.
- indicates:
 - The exception number of the exception being processed.
 - Whether there are preempted active exceptions.
 - The exception number of the highest priority pending exception
 - Whether any interrupts are pending.

See the register summary in [Table 50 on page 192](#), and the type descriptions in [Table 53 on page 195](#), for the ICSR attributes. The bit assignments are:

Figure 26. ICSR bit assignments

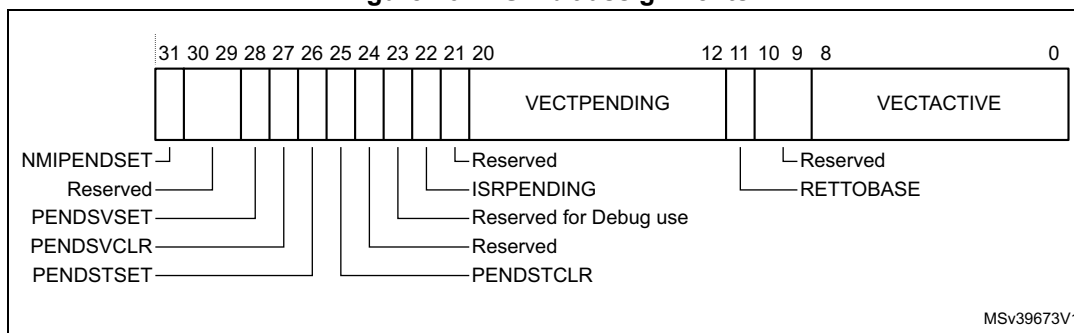

Table 53. ICSR bit assignments

Bits	Name	Type	Function
[31]	NMIPENDSET	RW	NMI set-pending bit. Write: 0: No effect. 1: Changes NMI exception state to pending. Read: 0: NMI exception is not pending. 1: NMI exception is pending. Because NMI is the highest-priority exception, normally the processor enters the NMI exception handler as soon as it registers a write of 1 to this bit, and entering the handler clears this bit to 0. A read of this bit by the NMI exception handler returns 1 only if the NMI signal is reasserted while the processor is executing that handler.
[30:29]	-	-	Reserved.
[28]	PENDSVSET	RW	PendSV set-pending bit. Write: 0: No effect. 1: Changes PendSV exception state to pending. Read: 0: PendSV exception is not pending. 1: PendSV exception is pending. Writing 1 to this bit is the only way to set the PendSV exception state to pending.
[27]	PENDSVCLR	WO	PendSV clear-pending bit. Write: 0: No effect. 1: Removes the pending state from the PendSV exception.
[26]	PENDSTSET	RW	SysTick exception set-pending bit. Write: 0: No effect. 1: Changes SysTick exception state to pending. Read: 0: SysTick exception is not pending. 1: SysTick exception is pending.

Table 53. ICSR bit assignments (continued)

Bits	Name	Type	Function
[25]	PENDSTCLR	WO	SysTick exception clear-pending bit. Write: 0: No effect. 1: Removes the pending state from the SysTick exception. This bit is WO. On a register read its value is Unknown.
[24]	-	-	Reserved.
[23]	Reserved for Debug use	RO	This bit is reserved for Debug use and reads-as-zero when the processor is not in Debug.
[22]	ISR_PENDING	RO	Interrupt pending flag, excluding NMI and Faults: 0: Interrupt not pending. 1: Interrupt pending.
[21]	-	-	Reserved.
[20:12]	VECT_PENDING	RO	Indicates the exception number of the highest priority pending enabled exception: 0: No pending exceptions. Nonzero: The exception number of the highest priority pending enabled exception. The value indicated by this field includes the effect of the BASEPRI and FAULTMASK registers, but not any effect of the PRIMASK register.
[11]	RETTOBASE	RO	Indicates whether there are preempted active exceptions: 0: There are preempted active exceptions to execute. 1: There are no active exceptions, or the currently-executing exception is the only active exception.
[10:9]	-	-	Reserved.
[8:0]	VECT_ACTIVE ⁽¹⁾	RO	Contains the active exception number: 0: Thread mode 1: The exception number ⁽¹⁾ of the currently active exception. Subtract 16 from this value to obtain the CMSIS IRQ number required to index into the Interrupt Clear-Enable, Set-Enable, Clear-Pending, Set-Pending, or Priority Registers, see Table 5 on page 24 .

1. This is the same value as IPSR bits[8:0], see [Interrupt program status register on page 23](#).

When writing to the ICSR, the effect is unpredictable if the user:

- Writes 1 to the PENDSVSET bit and writes 1 to the PENDSVCLR bit.
- Writes 1 to the PENDSTSET bit and writes 1 to the PENDSTCLR bit.

4.3.4 Vector table offset register

The VTOR indicates the offset of the vector table base address from memory address 0x00000000. See the register summary in [Table 50 on page 192](#) for its attributes. The bit assignments are:

Figure 27. VTOR bit assignments

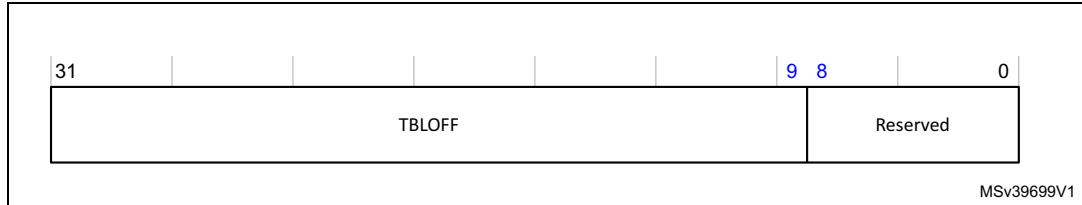

Table 54. VTOR bit assignments

Bits	Name	Function
[31:9]	TBLOFF	Vector table base offset field. It contains bits [29:7] of the offset of the table base from the bottom of the memory map.
[8:0]	-	Reserved.

When setting TBLOFF, the user must align the offset to the number of exception entries in the vector table.

The table alignment requirements mean that bits [8:0] of the table offset are always zero.

4.3.5 Application interrupt and reset control register

The AIRCR provides priority grouping control for the exception model, endian status for data accesses, and reset control of the system. See the register summary in [Table 50 on page 192](#) and [Table 55 on page 198](#) for its attributes.

To write to this register, the user must write 0x5FA to the VECTKEY field, otherwise the processor ignores the write.

The bit assignments are:

Figure 28. AIRCR bit assignments

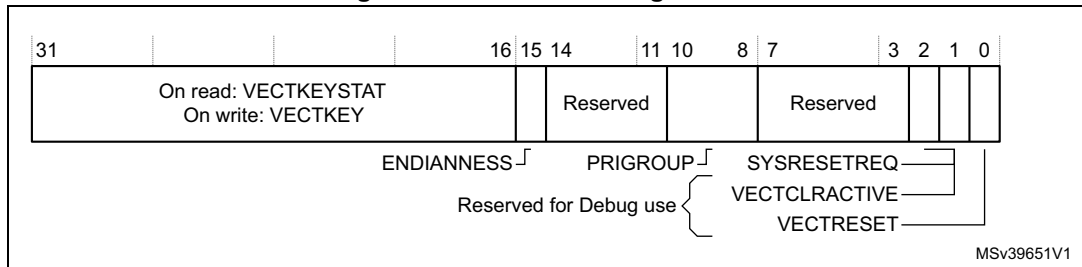

Table 55. AIRCR bit assignments

Bits	Name	Type	Function
[31:16]	Read: VECTKEYSTAT Write: VECTKEY	RW	Register key: Reads as 0xFA05 On writes, write 0x5FA to VECTKEY, otherwise the write is ignored.
[15]	ENDIANNESS	RO	Data endianness bit: 0: Little-endian.
[14:11]	-	-	Reserved
[10:8]	PRIGROUP	RW	Interrupt priority grouping field. This field determines the split of group priority from subpriority, see Binary point .
[7:3]	-	-	Reserved.
[2]	SYSRESETREQ	WO	System reset request: 0: No system reset request. 1: Asserts a signal to the outer system that requests a reset. This is intended to force a large system reset of all major components except for debug. This bit reads as 0.
[1]	VECTCLRACTIVE	WO	Reserved for Debug use. This bit reads as 0. When writing to the register the user must write 0 to this bit, otherwise behavior is Unpredictable.
[0]	VECTRESET	WO	Reserved for Debug use. This bit reads as 0. When writing to the register the user must write 0 to this bit, otherwise behavior is Unpredictable.

Binary point

The PRIGROUP field indicates the position of the binary point that splits the PRI_n fields in the Interrupt Priority Registers into separate *group priority* and *subpriority* fields. [Table 56](#) shows how the PRIGROUP value controls this split.

If the user implements fewer than 8 priority bits he might require more explanation here, and want to remove invalid rows from the table, and modify the entries in the *number of* columns.

Table 56. Priority grouping

PRIGROUP	Interrupt priority level value, $PRI_N[7:0]$			Number of	
	Binary point ⁽¹⁾	Group priority bits	Subpriority bits	Group priorities	Subpriorities
0b000	bxxxxxxx.y	[7:1]	[0]	128	2
0b001	bxxxxxx.yy	[7:2]	[1:0]	64	4
0b010	bxxxxx.yyy	[7:3]	[2:0]	32	8
0b011	bxxxx.yyyy	[7:4]	[3:0]	16	16
0b100	bxxx.yyyyy	[7:5]	[4:0]	8	32

Table 56. Priority grouping (continued)

PRIGROUP	Interrupt priority level value, PRI_N[7:0]			Number of	
	Binary point ⁽¹⁾	Group priority bits	Subpriority bits	Group priorities	Subpriorities
0b101	bxx.yyyyyy	[7:6]	[5:0]	4	64
0b110	bx.yyyyyy	[7]	[6:0]	2	128
0b111	b.yyyyyyy	None	[7:0]	1	256

1. PRI_n[7:0] field showing the binary point. x denotes a group priority field bit, and y denotes a subpriority field bit.

Note: Determining preemption of an exception uses only the group priority field, see [Interrupt priority grouping on page 43](#).

4.3.6 System control register

The SCR controls features of entry to and exit from Low-power state. See the register summary in [Table 50 on page 192](#) for its attributes. The bit assignments are

Figure 29. SCR bit assignments:

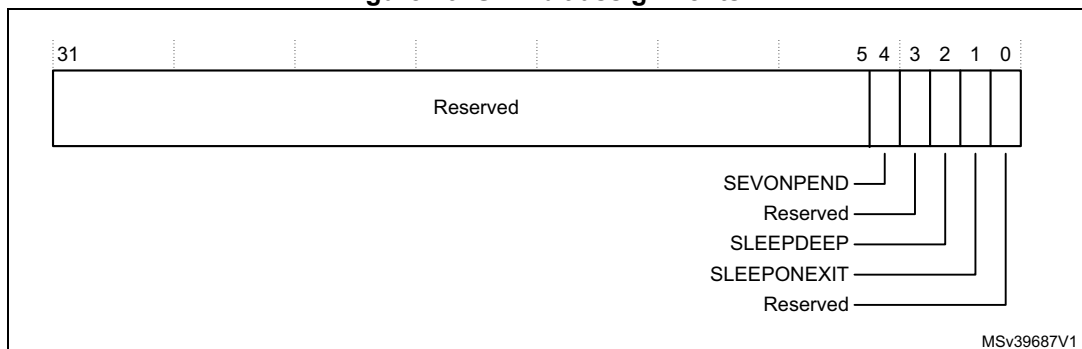

Table 57. SCR bit assignments

Bits	Name	Function
[31:5]	-	Reserved.
[4]	SEVONPEND	Send Event on Pending bit: 0: Only enabled interrupts or events can wakeup the processor, disabled interrupts are excluded. 1: Enabled events and all interrupts, including disabled interrupts, can wakeup the processor. When an event or interrupt enters pending state, the event signal wakes up the processor from WFE. If the processor is not waiting for an event, the event is registered and affects the next WFE. The processor also wakes up on execution of an SEV instruction or an external event.
[3]	-	Reserved.

Table 57. SCR bit assignments (continued)

Bits	Name	Function
[2]	SLEEPDEEP	Controls whether the processor uses sleep or deep sleep as its Low-power mode: 0: Sleep. 1: Deep sleep.
[1]	SLEEPONEXIT	Indicates sleep-on-exit when returning from Handler mode to Thread mode: 0: Do not sleep when returning to Thread mode. 1: Enter sleep, or deep sleep, on return from an ISR. Setting this bit to 1 enables an interrupt driven application to avoid returning to an empty main application.
[0]	-	Reserved.

4.3.7 Configuration and control register

The CCR controls entry to Thread mode and enables:

- The handlers for NMI, hard fault and faults escalated by FAULTMASK to ignore BusFaults.
- Trapping of divide by zero and unaligned accesses.
- Access to the STIR by unprivileged software, see [Software trigger interrupt register on page 189](#).
- Instruction and data cache enable control.

See the register summary in [Table 50 on page 192](#) for the CCR attributes.

The bit assignments are:

Figure 30. CCR bit assignments

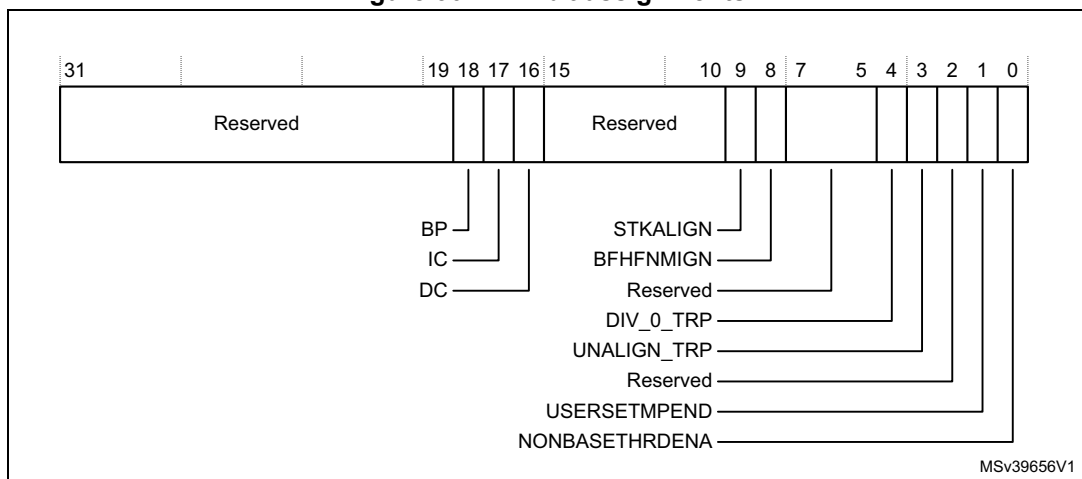

Table 58. CCR bit assignments

Bits	Name	Type	Function
[31:19]	-	-	Reserved.
[18]	BP	RO	Always reads-as-one. It indicates branch prediction is enabled.
[17]	IC	RW	Enables L1 instruction cache: 0: L1 instruction cache disabled. 1: L1 instruction cache enabled.
[16]	DC	RW	Enables L1 data cache: 0: L1 data cache disabled. 1: L1 data cache enabled.
[15:10]	-	-	Reserved.
[9]	STKALIGN	RO	Always reads-as-one. It indicates stack alignment on exception entry is 8-byte aligned. On exception entry, the processor uses bit[9] of the stacked PSR to indicate the stack alignment. On return from the exception it uses this stacked bit to restore the correct stack alignment.
[8]	BFHFNMI	RW	Enables handlers with priority -1 or -2 to ignore data BusFaults caused by load and store instructions. This applies to the hard fault, NMI, and FAULTMASK escalated handlers: 0: Data bus faults caused by load and store instructions cause a lock-up. 1: Handlers running at priority -1 and -2 ignore data bus faults caused by load and store instructions. Set this bit to 1 only when the handler and its data are in absolutely safe memory. The normal use of this bit is to probe system devices and bridges to detect control path problems and fix them.
[7:5]	-	-	Reserved.
[4]	DIV_0_TRP	RW	Enables faulting or halting when the processor executes an SDIV or UDIV instruction with a divisor of 0: 0: Do not trap divide by 0. 1: Trap divide by 0. When this bit is set to 0, a divide by zero returns a quotient of 0.
[3]	UNALIGN_TRP	RW	Enables unaligned access traps: 0: Do not trap unaligned halfword and word accesses. 1: Trap unaligned halfword and word accesses. If this bit is set to 1, an unaligned access generates a UsageFault. Unaligned LDM, STM, LDRD, and STRD instructions always fault irrespective of whether UNALIGN_TRP is set to 1.
[2]	-	-	Reserved.

Table 58. CCR bit assignments (continued)

Bits	Name	Type	Function
[1]	USERSETMPEND	RW	Enables unprivileged software access to the STIR, see Software trigger interrupt register on page 189 : 0: Disable. 1: Enable.
[0]	NONBASETHRDE NA	RW	Indicates how the processor enters Thread mode: 0: Processor can enter Thread mode only when no exception is active. 1: Processor can enter Thread mode from any level under the control of an EXC_RETURN value, see Exception return on page 46 .

4.3.8 System handler priority registers

The SHPR1-SHPR3 registers set the priority level, 0 to 255 of the exception handlers that have configurable priority.

SHPR1-SHPR3 are byte accessible. See the register summary in [Table 50 on page 192](#) for their attributes.

The system fault handlers and the priority field and register for each handler are:

Table 59. System fault handler priority fields

Handler	Field	Register description
MemManage	PRI_4	System handler priority register 1
BusFault	PRI_5	
UsageFault	PRI_6	
SVCall	PRI_11	System handler priority register 2
PendSV	PRI_14	System handler priority register 3
SysTick	PRI_15	

Each PRI_n field is 8 bits wide, but the processor implements only bits[7:M] of each field, and bits[M-1:0] read as zero and ignore writes.

System handler priority register 1

The bit assignments are:

Figure 31. SHPR1 bit assignments

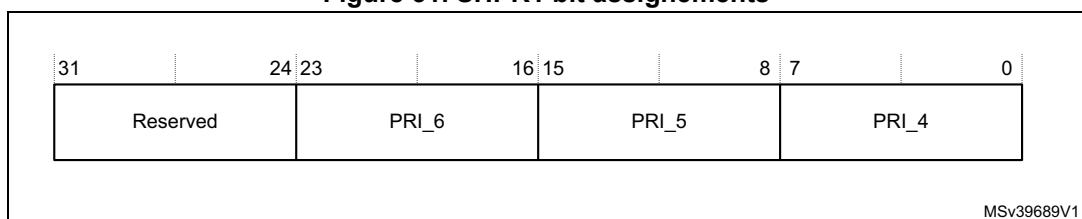

Table 60. SHPR1 register bit assignments

Bits	Name	Function
[31:24]	PRI_7	Reserved
[23:16]	PRI_6	Priority of system handler 6, UsageFault
[15:8]	PRI_5	Priority of system handler 5, BusFault
[7:0]	PRI_4	Priority of system handler 4, MemManage

System handler priority register 2

The bit assignments are:

Figure 32. SHPR2 bit assignments

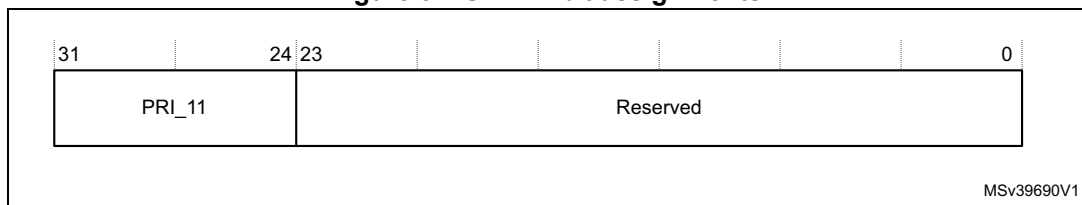

Table 61. SHPR2 register bit assignments

Bits	Name	Function
[31:24]	PRI_11	Priority of system handler 11, SVCcall
[23:0]	-	Reserved

System handler priority register 3

The bit assignments are:

Figure 33. SHPR3 bit assignments

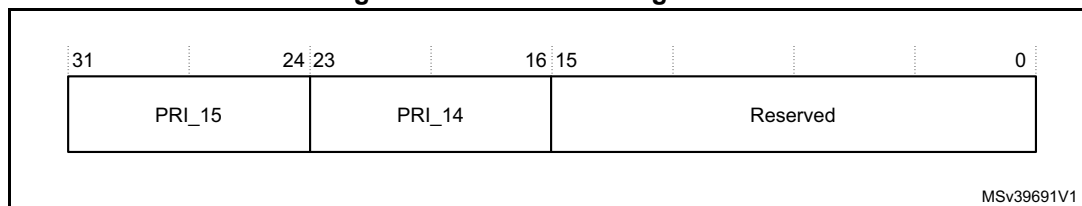

Table 62. SHPR3 register bit assignments

Bits	Name	Function
[31:24]	PRI_15	Priority of system handler 15, SysTick exception
[23:16]	PRI_14	Priority of system handler 14, PendSV
[15:0]	-	Reserved

4.3.9 System handler control and state register

The SHCSR enables the system handlers, and indicates:

- The pending status of the BusFault, MemManage fault, and SVC exceptions.
- The active status of the system handlers.

See the register summary in [Table 50 on page 192](#) for the SHCSR attributes. The bit assignments are:

Figure 34. SHCSR bit assignments

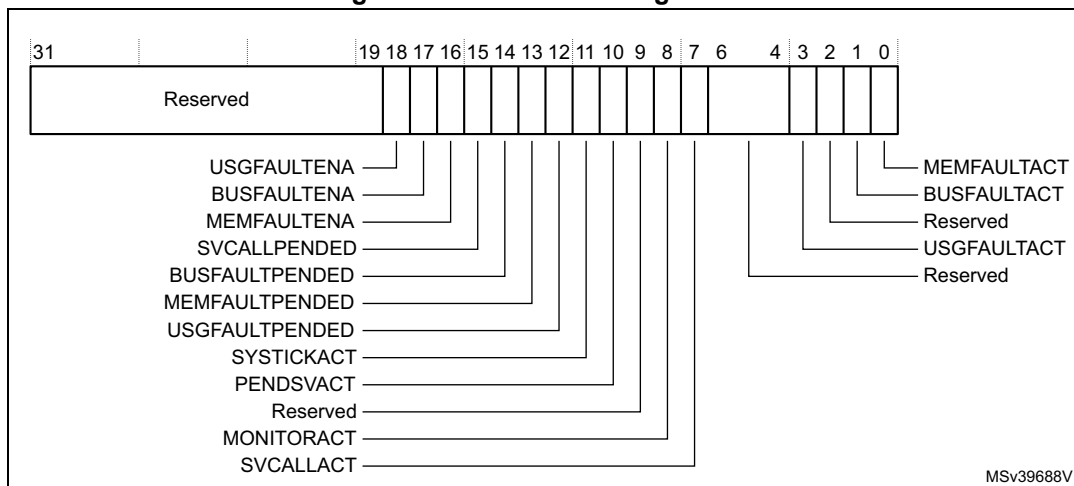

Table 63. SHCSR bit assignments

Bits	Name	Function
[31:19]	-	Reserved
[18]	USGFAULTENA	UsageFault enable bit, set to 1 to enable ⁽¹⁾
[17]	BUSFAULTENA	BusFault enable bit, set to 1 to enable ⁽¹⁾
[16]	MEMFAULTENA	MemManage enable bit, set to 1 to enable ⁽¹⁾
[15]	SVCALLPENDEDED	SVCAll pending bit, reads as 1 if exception is pending ⁽²⁾
[14]	BUSFAULTPENDEDED	BusFault exception pending bit, reads as 1 if exception is pending ⁽²⁾
[13]	MEMFAULTPENDEDED	MemManage exception pending bit, reads as 1 if exception is pending ⁽²⁾
[12]	USGFAULTPENDEDED	UsageFault exception pending bit, reads as 1 if exception is pending ⁽²⁾
[11]	SYSTICKACT	SysTick exception active bit, reads as 1 if exception is active ⁽³⁾
[10]	PENDSVACT	PendSV exception active bit, reads as 1 if exception is active
[9]	-	Reserved
[8]	MONITORACT	Debug monitor active bit, reads as 1 if Debug monitor is active
[7]	SVCALLACT	SVCAll active bit, reads as 1 if SVC call is active
[6:4]	-	Reserved
[3]	USGFAULTACT	UsageFault exception active bit, reads as 1 if exception is active

Table 63. SHCSR bit assignments (continued)

Bits	Name	Function
[2]	-	Reserved
[1]	BUSFAULTACT	BusFault exception active bit, reads as 1 if exception is active
[0]	MEMFAULTACT	MemManage exception active bit, reads as 1 if exception is active

1. Enable bits, set to 1 to enable the exception, or set to 0 to disable the exception.
2. Pending bits, read as 1 if the exception is pending, or as 0 if it is not pending. The user can write to these bits to change the pending status of the exceptions.
3. Active bits, read as 1 if the exception is active, or as 0 if it is not active. The user can write to these bits to change the active status of the exceptions, but see the Caution in this section.

If the user disables a system handler and the corresponding fault occurs, the processor treats the fault as a hard fault.

The user can write to this register to change the pending or active status of system exceptions. An OS kernel can write to the active bits to perform a context switch that changes the current exception type.

- A software that changes the value of an active bit in this register without correct adjustment to the stacked content can cause the processor to generate a fault exception. Ensure a software that writes to this register retains and subsequently restores the current active status.
- After having enabled the system handlers, if the user has to change the value of a bit in this register he must use a read-modify-write procedure to ensure that only the required bit is changed.

4.3.10 Configurable fault status register

The CFSR indicates the cause of a MemManage fault, BusFault, or UsageFault. See the register summary in [Table 50 on page 192](#) for its attributes. The bit assignments are:

Figure 35. CFSR bit assignments

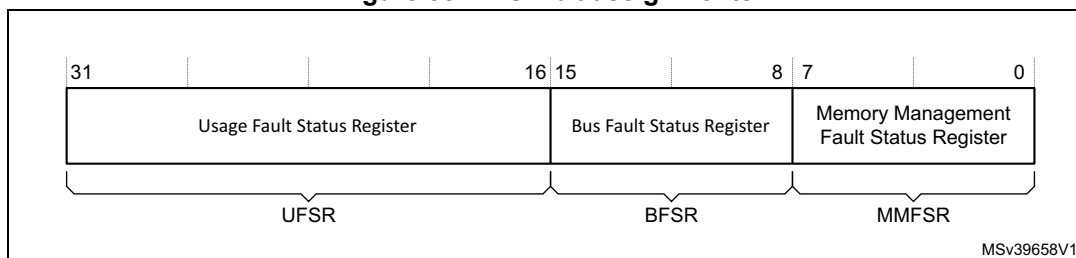

The following subsections describe the subregisters that make up the CFSR:

- [MemManage fault status register on page 206.](#)
- [BusFault status register on page 207.](#)
- [UsageFault status register on page 209.](#)

The CFSR is byte accessible. The CFSR or its subregisters can be accessed as follows:

- Access the complete CFSR with a word access to 0xE000ED28.
- Access the MMFSR with a byte access to 0xE000ED28.
- Access the MMFSR and BFSR with a halfword access to 0xE000ED28.
- Access the BFSR with a byte access to 0xE000ED29.
- Access the UFSR with a halfword access to 0xE000ED2A.

MemManage fault status register

The flags in the MMFSR indicate the cause of memory access faults. The bit assignments are:

Figure 36. MMFSR bit assignments

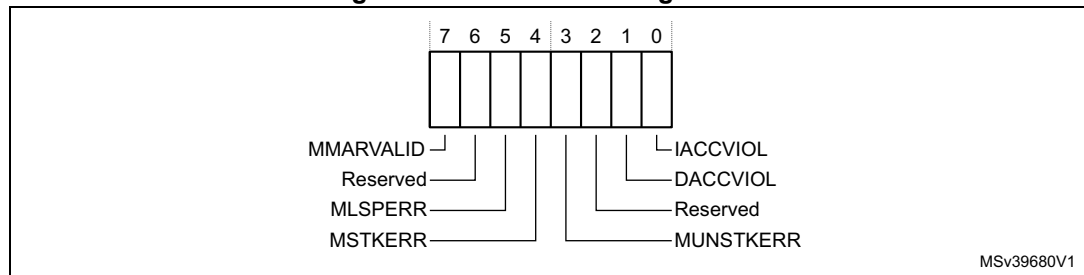

Table 64. MMFSR bit assignments

Bits	Name	Function
[7]	MMARVALID	<p><i>MemManage Fault Address register (MMFAR) valid flag:</i></p> <p>0: Value in MMAR is not a valid fault address. 1: MMAR holds a valid fault address.</p> <p>If a MemManage fault occurs and is escalated to a HardFault because of priority, the HardFault handler must set this bit to 0. This prevents problems on return to a stacked active MemManage fault handler whose MMAR value has been overwritten.</p>
[6]	-	Reserved.
[5]	MLSPERR	<p>0: No MemManage fault occurred during floating-point lazy state preservation. 1: A MemManage fault occurred during floating-point lazy state preservation.</p>
[4]	MSTKERR	<p>MemManage fault on stacking for exception entry:</p> <p>0: No stacking fault. 1: Stacking for an exception entry has caused one or more access violations.</p> <p>When this bit is 1, the SP is still adjusted but the values in the context area on the stack might be incorrect. The processor has not written a fault address to the MMAR.</p>

Table 64. MMFSR bit assignments (continued)

Bits	Name	Function
[3]	MUNSTKERR	MemManage fault on unstacking for a return from exception: 0: No unstacking fault. 1: Unstack for an exception return has caused one or more access violations. This fault is chained to the handler. This means that when this bit is 1, the original return stack is still present. The processor has not adjusted the SP from the failing return, and has not performed a new save. The processor has not written a fault address to the MMAR.
[2]	-	Reserved
[1]	DACCVIOL	Data access violation flag: 0: No data access violation fault. 1: The processor attempted a load or store at a location that does not permit the operation. When this bit is 1, the PC value stacked for the exception return points to the faulting instruction. The processor has loaded the MMAR with the address of the attempted access.
[0]	IACCVIOL	Instruction access violation flag: 0: No instruction access violation fault. 1: The processor attempted an instruction fetch from a location that does not permit execution. This fault occurs on any access to an XN region, even when the MPU is disabled or not present. When this bit is 1, the PC value stacked for the exception return points to the faulting instruction. The processor has not written a fault address to the MMAR.

The MMFSR bits are sticky. This means as one or more fault occurs, the associated bits are set to 1. A bit that is set to 1 is cleared to 0 only by writing 1 to that bit, or by a reset.

BusFault status register

The flags in the BFSR indicate the cause of a bus access fault. The bit assignments are:

Figure 37. BFSR bit assignments

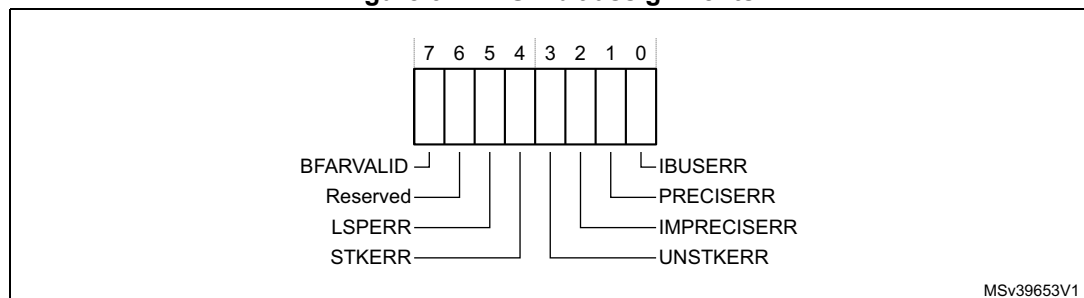

MSv39653V1

Table 65. BFSR bit assignments

Bits	Name	Function
[7]	BFARVALID	<p><i>BusFault Address register</i> (BFAR) valid flag: 0: Value in BFAR is not a valid fault address. 1: BFAR holds a valid fault address.</p> <p>The processor sets this bit to 1 after a BusFault where the address is known. Other faults can set this bit to 0, such as a MemManage fault occurring later.</p> <p>If a BusFault occurs and is escalated to a hard fault because of priority, the hard fault handler must set this bit to 0. This prevents problems if returning to a stacked active BusFault handler whose BFAR value has been overwritten.</p>
[6]	-	Reserved.
[5]	LSPERR	<p>0: No bus fault occurred during floating-point lazy state preservation. 1: A bus fault occurred during floating-point lazy state preservation.</p>
[4]	STKERR	<p>BusFault on stacking for exception entry: 0: No stacking fault. 1: Stacking for an exception entry has caused one or more BusFaults.</p> <p>When the processor sets this bit to 1, the SP is still adjusted but the values in the context area on the stack might be incorrect. The processor does not write a fault address to the BFAR.</p>
[3]	UNSTKERR	<p>BusFault on unstacking for a return from exception: 0: No unstacking fault. 1: Unstack for an exception return has caused one or more BusFaults.</p> <p>This fault is chained to the handler. This means that when the processor sets this bit to 1, the original return stack is still present. The processor does not adjust the SP from the failing return, does not performed a new save, and does not write a fault address to the BFAR.</p>
[2]	IMPRECISERR	<p>Imprecise data bus error: 0: No imprecise data bus error. 1: A data bus error has occurred, but the return address in the stack frame is not related to the instruction that caused the error.</p> <p>When the processor sets this bit to 1, it does not write a fault address to the BFAR. This is an asynchronous fault. Therefore, if it is detected when the priority of the current process is higher than the BusFault priority, the BusFault becomes pending and becomes active only when the processor returns from all higher priority processes. If a precise fault occurs before the processor enters the handler for the imprecise BusFault, the handler detects both IMPRECISERR set to 1 and one of the precise fault status bits set to 1.</p>
[1]	PRECISERR	<p>Precise data bus error: 0: No precise data bus error. 1: A data bus error has occurred, and the PC value stacked for the exception return points to the instruction that caused the fault.</p> <p>When the processor sets this bit to 1, it writes the faulting address to the BFAR.</p>
[0]	IBUSERR	<p>Instruction bus error: 0: No instruction bus error. 1: Instruction bus error.</p> <p>The processor detects the instruction bus error on prefetching an instruction, but it sets the IBUSERR flag to 1 only if it attempts to issue the faulting instruction.</p> <p>When the processor sets this bit to 1, it does not write a fault address to the BFAR.</p>

The BFSR bits are sticky. This means as one or more fault occurs, the associated bits are set to 1. A bit that is set to 1 is cleared to 0 only by writing 1 to that bit, or by a reset.

UsageFault status register

The UFSR indicates the cause of a UsageFault. The bit assignments are:

Figure 38. UFSR bit assignments

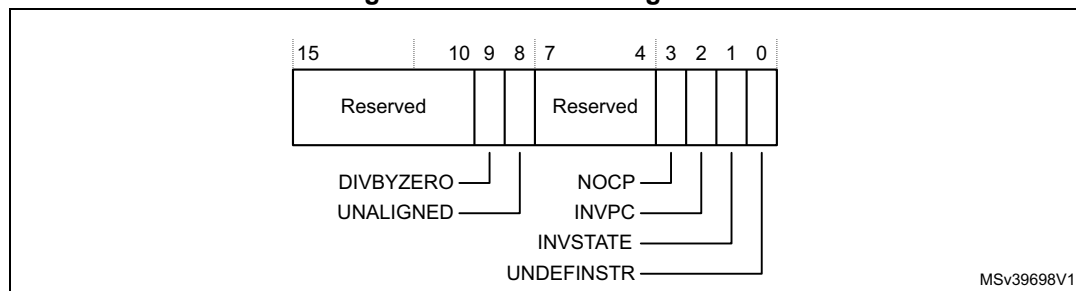

Table 66. UFSR bit assignments

Bits	Name	Function
[15:10]	-	Reserved.
[9]	DIVBYZERO	<p>Divide by zero UsageFault:</p> <p>0: No divide by zero fault, or divide by zero trapping not enabled. 1: The processor has executed an SDIV or UDIV instruction with a divisor of 0.</p> <p>When the processor sets this bit to 1, the PC value stacked for the exception return points to the instruction that performed the divide by zero. Enable trapping of divide by zero by setting the DIV_0_TRP bit in the CCR to 1, see Configuration and control register on page 200.</p>
[8]	UNALIGNED	<p>Unaligned access UsageFault:</p> <p>0: No unaligned access fault, or unaligned access trapping not enabled. 1: The processor has made an unaligned memory access.</p> <p>Enable trapping of unaligned accesses by setting the UNALIGN_TRP bit in the CCR to 1, see Configuration and control register on page 200. Unaligned LDM, STM, LDRD, and STRD instructions always fault irrespective of the setting of UNALIGN_TRP.</p>
[7:4]	-	Reserved.
[3]	NOCP	<p>No coprocessor UsageFault:</p> <p>0: No UsageFault caused by attempting to access a coprocessor. 1: The processor has attempted to access a coprocessor.</p> <p>The processor does not support coprocessor instructions:</p>
[2]	INVPC	<p>Invalid PC load UsageFault, caused by an invalid PC load by EXC_RETURN:</p> <p>0: No invalid PC load UsageFault. 1: The processor has attempted an illegal load of EXC_RETURN to the PC, as a result of an invalid context, or an invalid EXC_RETURN value.</p> <p>When this bit is set to 1, the PC value stacked for the exception return points to the instruction that tried to perform the illegal load of the PC.</p>

Table 66. UFSR bit assignments (continued)

Bits	Name	Function
[1]	INVSTATE	Invalid state UsageFault: 0: No invalid state UsageFault. 1: The processor has attempted to execute an instruction that makes illegal use of the EPSR. When this bit is set to 1, the PC value stacked for the exception return points to the instruction that attempted the illegal use of the EPSR. This bit is not set to 1 if an undefined instruction uses the EPSR.
[0]	UNDEFINSTR	Undefined instruction UsageFault: 0: No undefined instruction UsageFault. 1: The processor has attempted to execute an undefined instruction. When this bit is set to 1, the PC value stacked for the exception return points to the undefined instruction. An undefined instruction is an instruction that the processor cannot decode.

The UFSR bits are sticky. This means as one or more fault occurs, the associated bits are set to 1. A bit that is set to 1 is cleared to 0 only by writing 1 to that bit, or by a reset.

4.3.11 HardFault status register

The HFSR gives information about events that activate the HardFault handler. See the register summary in [Table 50 on page 192](#) for its attributes.

This register is read, write to clear. This means that bits in the register read normally, but writing 1 to any bit clears that bit to 0. The bit assignments are:

Figure 39. HFSR bit assignments

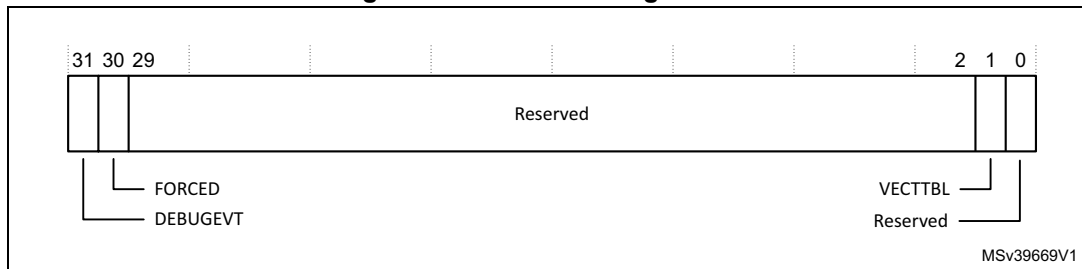

Table 67. HFSR bit assignments

Bits	Name	Function
[31]	DEBUGEVT	Reserved for Debug use. When writing to the register the user must write 1 to this bit, otherwise behavior is UNPREDICTABLE.
[30]	FORCED	Indicates a forced hard fault, generated by escalation of a fault with configurable priority that cannot be handled, either because of priority or because it is disabled: 0: No forced HardFault. 1: Forced HardFault. When this bit is set to 1, the HardFault handler must read the other fault status registers to find the cause of the fault.
[29:2]	-	Reserved.
[1]	VECTTBL	Indicates a BusFault on a vector table read during exception processing: 0: No BusFault on vector table read. 1: BusFault on vector table read. This error is always handled by the hard fault handler. When this bit is set to 1, the PC value stacked for the exception return points to the instruction that was preempted by the exception.
[0]	-	Reserved.

The HFSR bits are sticky. This means as one or more fault occurs, the associated bits are set to 1. A bit that is set to 1 is cleared to 0 only by writing 1 to that bit, or by a reset.

4.3.12 MemManage fault address register

The MMFAR contains the address of the location that generated a MemManage fault. See the register summary in [Table 50 on page 192](#) for its attributes. The bit assignments are:

Table 68. MMFAR bit assignments

Bits	Name	Function
[31:0]	ADDRESS	When the MMARVALID bit of the MMFSR is set to 1, this field holds the address of the location that generated the MemManage fault

When an unaligned access faults, the address is the actual address that faulted. Because a single read or write instruction can be split into multiple aligned accesses, the fault address can be any address in the range of the requested access size.

Flags in the MMFSR indicate the cause of the fault, and whether the value in the MMFAR is valid. See [Configuration and control register on page 200](#).

4.3.13 BusFault address register

The BFAR contains the address of the location that generated a BusFault. See the register summary in [Table 50 on page 192](#) for its attributes. The bit assignments are:

Table 69. BFAR bit assignments

Bits	Name	Function
[31:0]	ADDRESS	When the BFARVALID bit of the BFSR is set to 1, this field holds the address of the location that generated the BusFault

When an unaligned access faults the address in the BFAR is the one requested by the instruction, even if it is not the address of the fault.

Flags in the BFSR indicate the cause of the fault, and whether the value in the BFAR is valid. See [Table 50 on page 192](#).

4.3.14 System control block design hints and tips

Ensure software uses aligned accesses of the correct size to access the system control block registers:

- Except for the CFSR and SHPR1-SHPR3, it must use aligned word accesses.
- For the CFSR and SHPR1-SHPR3 it can use byte or aligned halfword or word accesses.

The processor does not support unaligned accesses to system control block registers.

In a fault handler, to determine the true faulting address:

1. Read and save the MMFAR or BFAR value.
2. Read the MMARVALID bit in the MMFSR, or the BFARVALID bit in the BFSR. The MMFAR or BFAR address is valid only if this bit is 1.

The software must follow this sequence because another higher priority exception might change the MMFAR or BFAR value. For example, if a higher priority handler preempts the current fault handler, the other fault might change the MMFAR or BFAR value.

In addition, the CMSIS provides a number of functions for system control, including:

Table 70. CMSIS function for system control

CMSIS system control function	Description
<code>void NVIC_SystemReset (void)</code>	Reset the system

4.4 System timer, SysTick

The processor has a 24-bit system timer, SysTick, that counts down from the reload value to zero, reloads, that is wraps to, the value in the SYST_RVR register on the next clock edge, then counts down on subsequent clocks.

When the processor is halted for debugging the counter does not decrement.

The system timer registers are:

Table 71. System timer registers summary

Address	Name	Type	Required privilege	Reset value	Description
0xE000E010	SYST_CSR	RW	Privileged	0x00000004	<i>SysTick control and status register</i>
0xE000E014	SYST_RVR	RW	Privileged	UNKNOWN	<i>SysTick reload value register</i>
0xE000E018	SYST_CVR	RW	Privileged	UNKNOWN	<i>SysTick current value register</i>
0xE000E01C	SYST_CALIB	RO	Privileged	0xC0000000	<i>SysTick calibration value register</i>

4.4.1 SysTick control and status register

The SysTick SYST_CSR register enables the SysTick features. See the register summary in [Table 71](#) for its attributes. The bit assignments are:

Figure 40. SysTick SYST_CSR bit assignments

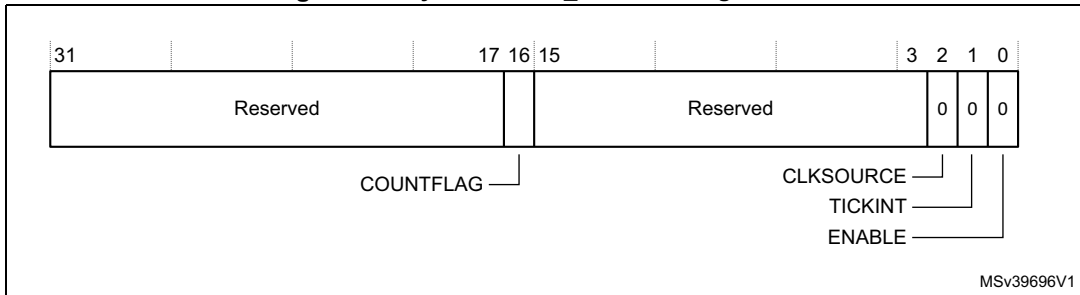

Table 72. SysTick SYST_CSR bit assignments

Bits	Name	Function
[31:17]	-	Reserved.
[16]	COUNTFLAG	Returns 1 if timer counted to 0 since last time this was read.
[15:3]	-	Reserved.
[2]	CLKSOURCE	Indicates the clock source: – 0: External clock. – 1: Processor clock.
[1]	TICKINT	Enables SysTick exception request: 0: Counting down to zero does not assert the SysTick exception request. 1: Counting down to zero asserts the SysTick exception request. Software can use COUNTFLAG to determine if SysTick has ever counted to zero.
[0]	ENABLE	Enables the counter: 0: Counter disabled. 1: Counter enabled.

When ENABLE is set to 1, the counter loads the RELOAD value from the SYST_RVR register and then counts down. On reaching 0, it sets the COUNTFLAG to 1 and optionally asserts the SysTick depending on the value of TICKINT. It then loads the RELOAD value again, and begins counting.

4.4.2 SysTick reload value register

The SYST_RVR register specifies the start value to load into the SYST_CVR register. See the register summary in [Table 71 on page 213](#) for its attributes. The bit assignments are:

Figure 41. SYST_RVR bit assignments

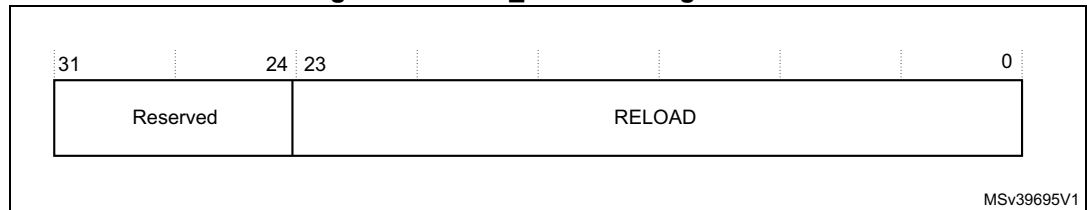

Table 73. SYST_RVR bit assignments

Bits	Name	Function
[31:24]	-	Reserved.
[23:0]	RELOAD	Value to load into the SYST_CVR register when the counter is enabled and when it reaches 0, see Calculating the RELOAD value .

Calculating the RELOAD value

The RELOAD value can be any value in the range 0x00000001-0x00FFFFFF. A start value of 0 is possible, but has no effect because the SysTick exception request and COUNTFLAG are activated when counting from 1 to 0.

The RELOAD value is calculated according to its use. For example, to generate a multi-shot timer with a period of N processor clock cycles, use a RELOAD value of N-1. If the SysTick interrupt is required every 100 clock pulses, set RELOAD to 99.

4.4.3 SysTick current value register

The SYST_CVR register contains the current value of the SysTick counter. See the register summary in [Table 71 on page 213](#) for its attributes. The bit assignments are

Figure 42. SYST_CVR bit assignments:

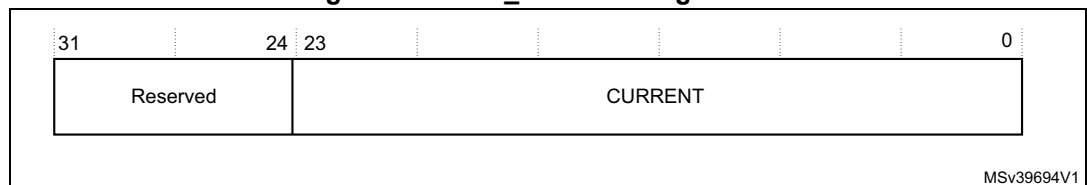

Table 74. SYST_CVR bit assignments

Bits	Name	Function
[31:24]	-	Reserved.
[23:0]	CURRENT	Reads return the current value of the SysTick counter. A write of any value clears the field to 0, and also clears the SYST_CSR COUNTFLAG bit to 0.

4.4.4 SysTick calibration value register

The SYST_CALIB register indicates the SysTick calibration properties. See the register summary in [Table 71 on page 213](#) for its attributes. The bit assignments are:

Figure 43. SYST_CALIB bit assignments

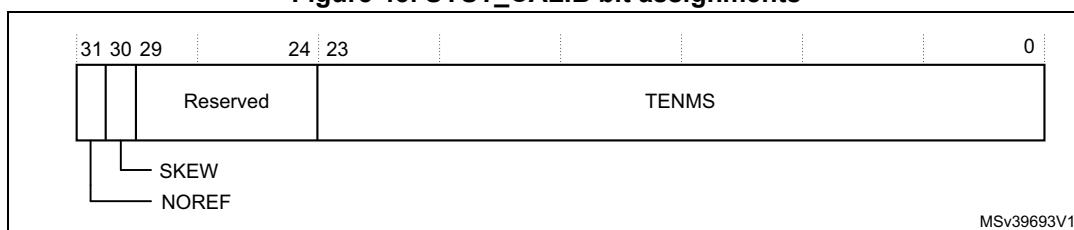

Table 75. SYST_CALIB bit assignments

Bits	Name	Function
[31]	NOREF	Indicates whether the device provides a reference clock to the processor: 0: Reference clock provided. 1: No reference clock provided. If the device does not provide a reference clock, the SYST_CSR.CLKSOURCE bit reads-as-one and ignores writes.
[30]	SKEW	Indicates whether the TENMS value is exact: 0: TENMS value is exact. 1: TENMS value is inexact, or not given. An inexact TENMS value can affect the suitability of SysTick as a software real time clock.
[29:24]	-	Reserved.
[23:0]	TENMS	Reload value for 10ms (100Hz) timing, subject to system clock skew errors. If the value reads as zero, the calibration value is not known.

If the calibration information is not known, calculate the calibration value required from the frequency of the processor clock or external clock.

4.4.5 SysTick design hints and tips

The SysTick counter runs on the processor clock. If this clock signal is stopped for Low-power mode, the SysTick counter stops.

Ensure the software uses aligned word accesses to access the SysTick registers.

The SysTick counter reload and current value are undefined at reset, the correct initialization sequence for the SysTick counter is:

1. Program reload value.
2. Clear current value.
3. Program Control and Status register.

In addition, the CMSIS provides a number of functions for SysTick control, including:

Table 76. CMSIS functions for SysTick control

CMSIS SysTick control function	Description
<code>uint32_t SysTick_Config(uint32_t ticks)</code>	Creates a periodic SysTick interrupt using the SysTick timer, with a interval defined by the ticks parameter.

4.5 Processor features

The processor features registers provide a software with cache configuration information. The identification space registers are:

Table 77. Identification space summary

Address	Name	Type	Required privilege	Reset value	Description
0xE000ED78	CLIDR	RO	Privileged	0x09000003	Cache level ID register
0xE000ED7C	CTR	RO	Privileged	0x8303C003	Cache type register on page 218
0xE000ED80	CCSIDR	RO	Privileged	Unknown	Cache size ID register on page 219
0xE000ED84	CSSELR	RW	Privileged	Unknown	Cache size selection register on page 220

All the registers are only accessible by privileged loads and stores. Unprivileged accesses to these registers result in a BusFault.

4.5.1 Cache level ID register

The CLIDR identifies the type of cache, or caches, implemented at each level, and the level of coherency and unification. See the register summary in [Table 77 on page 217](#) for its attributes. The bit assignments are:

Figure 44. CLIDR bit assignments

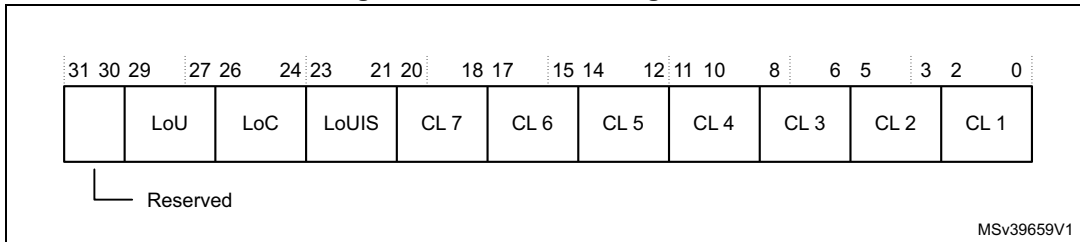

Table 78. CLIDR bit assignments

Bits	Name	Function
[31:30]	-	SBZ.
[29:27]	LoU	Level of Unification. 0b001: Level 2, if either cache is implemented. 0b000: Level 1, if neither instruction nor data cache is implemented.
[26:24]	LoC	Level of Coherency. 0b001: Level 2, if either cache is implemented. 0b000: Level 1, if neither instruction nor data cache is implemented.
[23:21]	LoUIS	RAZ.
[20:18]	CL 7	0b000: No cache at CL 7.
[17:15]	CL 6	0b000: No cache at CL 6.

Table 78. CLIDR bit assignments (continued)

Bits	Name	Function
[14:12]	CL 5	0b000: No cache at CL 5.
[11:9]	CL 4	0b000: No cache at CL 4.
[8:6]	CL 3	0b000: No cache at CL 3.
[5:3]	CL 2	0b000: No cache at CL 2.
[2]	CL 1	RAZ: Indicates no unified cache at CL 1.
[1]	CL 1	1: Data cache is implemented. 0: No data cache is implemented.
[0]	CL 1	1: An instruction cache is implemented. 0: No instruction cache is implemented.

4.5.2 Cache type register

The CTR provides information about the cache architecture. See the register summary in [Table 77 on page 217](#) for its attributes. The bit assignments are:

Figure 45. CTR bit assignments

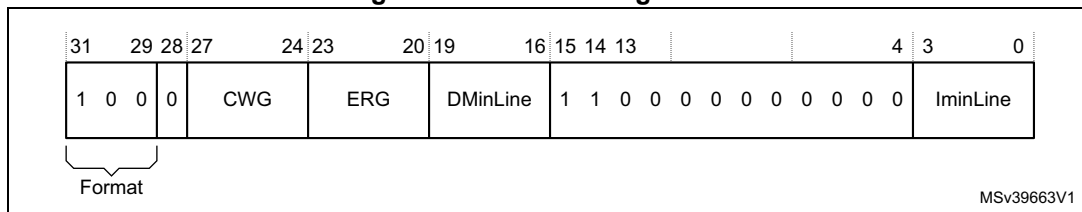

Table 79. CTR bit assignments

Bits	Name	Description
[31:29]	Format	Register format. 0b100: Armv7 register format.
[28]	-	Reserved, RAZ.
[27:24]	CWG	Cache Writeback Granule. 0b0011: 8 word granularity for the Cortex [®] -M7 processor.
[23:20]	ERG	Exclusives Reservation Granule. 0b0000: The local monitor within the processor does not hold any physical address. It treats any STREX instruction access as matching the address of the previous LDREX instruction. This means that the implemented exclusive reservation granule is the entire memory address range.
[19:16]	DMinLine	Smallest cache line of all the data and unified caches under the core control. 0b0011: 8 words for the Cortex [®] -M7 processor.
[15:14]	-	All bits RAO.

Table 79. CTR bit assignments (continued)

Bits	Name	Description
[13:4]	-	Reserved, RAZ.
[3:0]	IminLine	Smallest cache line of all the instruction caches under the control of the processor. 0b0011: 8 words for the Cortex [®] -M7 processor.

4.5.3 Cache size ID register

The CCSIDR identifies the configuration of the cache currently selected by the CSSELR. If no instruction or data cache is configured, the corresponding CCSIDR is RAZ. See the register summary in [Table 77 on page 217](#) for its attributes. The bit assignments are:

Figure 46. CCSIDR bit assignments

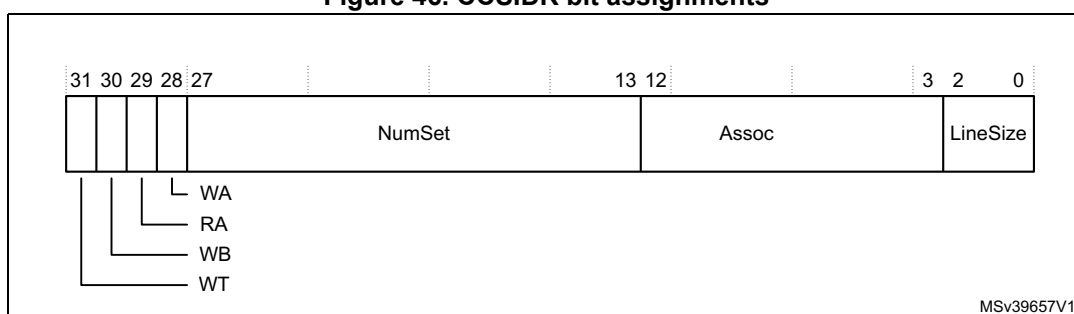

Table 80. CCSIDR bit assignments

Bits	Name	Function ⁽¹⁾
[31]	WT	Indicates support available for Write-Through: 1: Write-Through support available.
[30]	WB	Indicates support available for Write-Back: 1: Write-Back support available.
[29]	RA	Indicates support available for read allocation: 1: Read allocation support available.
[28]	WA	Indicates support available for write allocation: 1: Write allocation support available.
[27:13]	NumSets	Indicates the number of sets as: (number of sets) - 1.
[12:3]	Associativity	Indicates the number of ways as: (number of ways) - 1.
[2:0]	LineSize	Indicates the number of words in each cache line.

1. See [Table 81 on page 220](#) for valid bit field encodings.

The LineSize field is encoded as 2 less than log₂ of the number of words in the cache line. For example, a value of 0x0 indicates there are four words in a cache line, that is the minimum size for the cache. A value of 0x1 indicates there are eight words in a cache line.

Table 81 shows the individual bit field and complete register encodings for the CCSIDR. Use this to determine the cache size for the L1 data or instruction cache selected by the Cache Size Selection Register (CSSELR). See Cache size selection register.

Table 81. CCSIDR encodings

CSSELR	Cache	Size	Complete register encoding	Register bit field encoding						
				WT	WB	RA	WA	NumSets	Associativity	LineSize
0x0	Data cache	4 Kbytes	0xF003E019	1	1	1	1	0x001F	0x3	0x1
		8 Kbytes	0xF007E019					0x003F		
		16 Kbytes	0xF00FE019					0x007F		
		32 Kbytes	0xF01FE019					0x00FF		
		64 Kbytes	0xF03FE019					0x01FF		
0x1	Instruction cache	4 Kbytes	0xF007E009	1	1	1	1	0x003F	0x1	0x1
		8 Kbytes	0xF00FE009					0x007F		
		16 Kbytes	0xF01FE009					0x00FF		
		32 Kbytes	0xF03FE009					0x01FF		
		64 Kbytes	0xF07FE009					0x03FF		

4.5.4 Cache size selection register

The CSSELR selects the cache whose configuration is currently visible in the CCSIDR. See the register summary in Table 77 on page 217 for its attributes. The bit assignments are:

Figure 47. CSSELR bit assignments

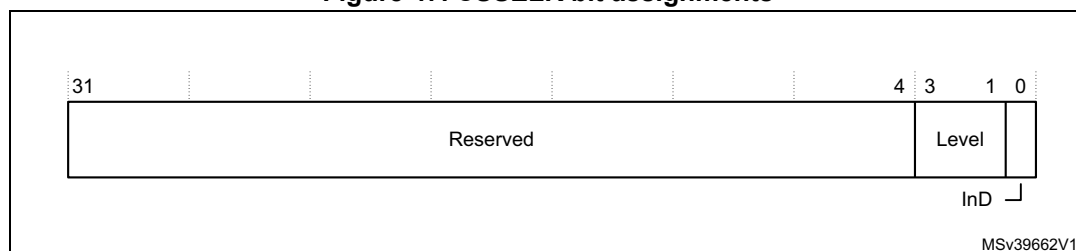

Table 82. CSSELR bit assignments

Bit	Name	Description
[31:4]	-	RESERVED
[3:1]	Level	Identifies the cache level selected. 0b000: Level 1 cache. This field is read only, writes are ignored.
[0]	InD	Enables selection of instruction or data cache: 0: Data cache. 1: Instruction cache.

4.6 Memory protection unit

The *Memory Protection Unit* (MPU) divides the memory map into a number of regions, and defines the location, size, access permissions, and memory attributes of each region. It supports:

- Independent attribute settings for each region.
- Overlapping regions.
- Export of memory attributes to the system.

The memory attributes affect the behavior of memory accesses to the region. The Cortex[®]-M7 MPU defines:

- 8 or 16 separate memory regions, 0-7 or 0-15.
- A background region.

When memory regions overlap, a memory access is affected by the attributes of the region with the highest number. For example, the attributes for region 7 take precedence over the attributes of any region that overlaps region 7.

The background region has the same memory access attributes as the default memory map, but is accessible from privileged software only.

The Cortex[®]-M7 MPU memory map is unified. This means instruction accesses and data accesses have same region settings.

If a program accesses a memory location that is prohibited by the MPU, the processor generates a MemManage fault. This causes a fault exception, and might cause termination of the process in an OS environment. In an OS environment, the kernel can update the MPU region setting dynamically based on the process to be executed. Typically, an embedded OS uses the MPU for memory protection.

The configuration of MPU regions is based on memory types, see [Memory regions, types and attributes on page 33](#).

[Table 83](#) shows the possible MPU region attributes. These include Shareability and cache behavior attributes that are generally only relevant when the processor is configured with caches.

Table 83. Memory attributes summary

Memory type	Shareability	Other attributes	Description
Strongly-ordered	-	-	All accesses to Strongly-ordered memory occur in program order. All Strongly-ordered regions are assumed to be shared.
Device	Shared	-	Memory-mapped peripherals that several processors share.
-	Non-shared	-	Memory-mapped peripherals that only a single processor uses.

Table 83. Memory attributes summary (continued)

Memory type	Shareability	Other attributes	Description
Normal	Shared	Non-cacheable Write-through Cacheable Write-back Cacheable	Normal memory that is shared between several processors.
-	Non-shared	Non-cacheable Write-through Cacheable Write-back Cacheable	Normal memory that only a single processor uses.

Use the MPU registers to define the MPU regions and their attributes. The MPU registers are:

Table 84. MPU registers summary

Address	Name	Type	Required privilege	Reset value	Description
0xE000ED90	MPU_TYPE	RO	Privileged	0x00000800	MPU type register on page 223
0xE000ED94	MPU_CTRL	RW	Privileged	0x00000000	MPU control register on page 223
0xE000ED98	MPU_RNR	RW	Privileged	Unknown	MPU region number register on page 225
0xE000ED9C	MPU_RBAR	RW	Privileged	Unknown	MPU region base address register on page 225
0xE000EDA0	MPU_RASR	RW	Privileged	_(1)	MPU region attribute and size register on page 226
0xE000EDA4	MPU_RBAR_A1	RW	Privileged	Unknown	Alias of RBAR, see MPU region base address register on page 225
0xE000EDA8	MPU_RASR_A1	RW	Privileged	_(1)	Alias of RASR, see MPU region attribute and size register on page 226
0xE000EDAC	MPU_RBAR_A2	RW	Privileged	Unknown	Alias of RBAR, see MPU region base address register on page 225
0xE000EDB0	MPU_RASR_A2	RW	Privileged	_(1)	Alias of RASR, see MPU region attribute and size register on page 226
0xE000EDB4	MPU_RBAR_A3	RW	Privileged	Unknown	Alias of RBAR, see MPU region base address register on page 225
0xE000EDB8	MPU_RASR_A3	RW	Privileged	_(1)	Alias of RASR, see MPU region attribute and size register on page 226

1. Unknown apart from the ENABLE field, which is reset to 0.

4.6.1 MPU type register

The MPU_TYPE register indicates whether the MPU is present, and if so, how many regions it supports. If the MPU is not present the MPU_TYPE register is RAZ. See the register summary in [Table 84](#) for its attributes. The bit assignments are:

Figure 48. TYPE bit assignments

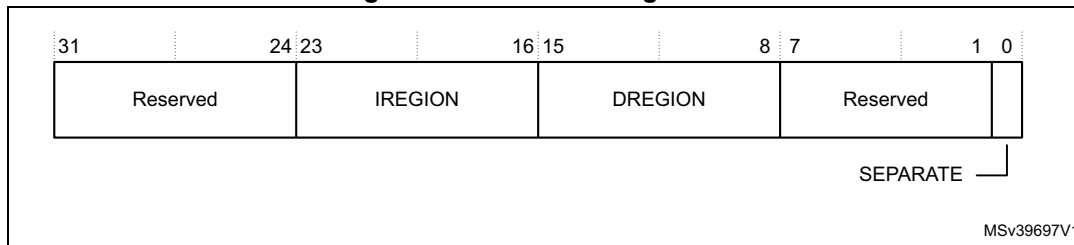

Table 85. TYPE bit assignments

Bits	Name	Function
[31:24]	-	Reserved.
[23:16]	IREGION	Indicates the number of supported MPU instruction regions. Always contains 0x00. The MPU memory map is unified and is described by the DREGION field.
[15:8]	DREGION	Indicates the number of supported MPU data regions: 0x08: 8 MPU regions. 0x10: 16 MPU regions.
[7:1]	-	Reserved.
[0]	SEPARATE	Indicates support for unified or separate instruction and data memory maps: 0: Unified.

4.6.2 MPU control register

The MPU_CTRL register:

- Enables the MPU.
- Enables the default memory map background region.
- Enables use of the MPU when in the hard fault, *Non Maskable Interrupt* (NMI), and FAULTMASK escalated handlers.

See the register summary in [Table 84 on page 222](#) for the MPU_CTRL attributes. The bit assignments are:

Figure 49. MPU_CTRL bit assignments

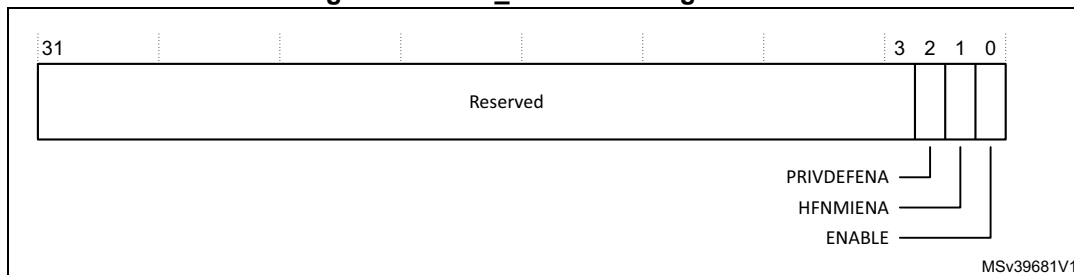

Table 86. MPU_CTRL bit assignments

Bits	Name	Function
[31:3]	-	Reserved.
[2]	PRIVDEFENA	<p>Enables privileged software access to the default memory map:</p> <p>0: If the MPU is enabled, disables use of the default memory map. Any memory access to a location not covered by any enabled region causes a fault.</p> <p>1: If the MPU is enabled, enables use of the default memory map as a background region for privileged software accesses.</p> <p>When enabled, the background region acts as if it is region number -1. Any region that is defined and enabled has priority over this default map.</p> <p>If the MPU is disabled, the processor ignores this bit.</p>
[1]	HFNMIENA	<p>Enables the operation of MPU during hard fault, NMI, and FAULTMASK handlers.</p> <p>When the MPU is enabled:</p> <p>0: MPU is disabled during hard fault, NMI, and FAULTMASK handlers, regardless of the value of the ENABLE bit.</p> <p>1: The MPU is enabled during hard fault, NMI, and FAULTMASK handlers.</p> <p>When the MPU is disabled, if this bit is set to 1 the behavior is Unpredictable.</p>
[0]	ENABLE	<p>Enables the MPU:</p> <p>0: MPU disabled.</p> <p>1: MPU enabled.</p>

When ENABLE and PRIVDEFENA are both set to 1:

- For privileged accesses, the *default memory map* is as described in [Cortex®-M7 configurations on page 30](#). Any access by privileged software that does not address an enabled memory region behaves as defined by the default memory map.
- Any access by unprivileged software that does not address an enabled memory region causes a MemManage fault.

XN and Strongly-ordered rules always apply to the System Control Space regardless of the value of the ENABLE bit.

When the ENABLE bit is set to 1, at least one region of the memory map must be enabled for the system to function unless the PRIVDEFENA bit is set to 1. If the PRIVDEFENA bit is set to 1 and no regions are enabled, then only privileged software can operate.

When the ENABLE bit is set to 0, the system uses the default memory map. This has the same memory attributes as if the MPU is not implemented, see [Table 77 on page 217](#). The default memory map applies to accesses from both privileged and unprivileged software.

When the MPU is enabled, accesses to the System Control Space and vector table are always permitted. Other areas are accessible based on regions and whether PRIVDEFENA is set to 1.

Unless HFNMIENA is set to 1, the MPU is not enabled when the processor is executing the handler for an exception with priority -1 or -2. These priorities are only possible when handling a hard fault or NMI exception, or when FAULTMASK is enabled. Setting the HFNMIENA bit to 1 enables the MPU when operating with these two priorities.

4.6.3 MPU region number register

The MPU_RNR selects which memory region is referenced by the MPU_RBAR and MPU_RASR registers. See the register summary in [Table 77 on page 217](#) for its attributes. The bit assignments are:

Figure 50. MPU_RNR bit assignments

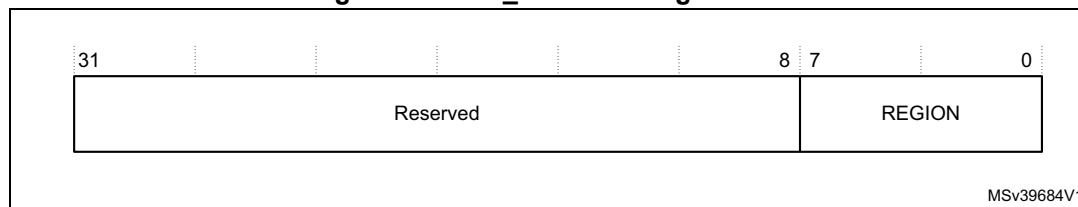

Table 87. MPU_RNR bit assignments

Bits	Name	Function
[31:8]	-	Reserved.
[7:0]	REGION	Indicates the MPU region referenced by the MPU_RBAR and MPU_RASR registers. The MPU supports 8 or 16 memory regions, so the permitted values of this field are 0-7 or 0-15.

Normally, the user writes the required region number to this register before accessing the MPU_RBAR or MPU_RASR. However the region number can be changed by writing to the MPU_RBAR with the VALID bit set to 1, see [MPU region base address register](#). This write updates the value of the REGION field.

4.6.4 MPU region base address register

The MPU_RBAR defines the base address of the MPU region selected by the MPU_RNR, and can update the value of the MPU_RNR. See the register summary in [Table 84 on page 222](#) for its attributes.

Write MPU_RBAR with the VALID bit set to 1 to change the current region number and update the MPU_RNR. See the register summary in [Table 84 on page 222](#) for its attributes. The bit assignments are

Figure 51. MPU_RBAR bit assignments:

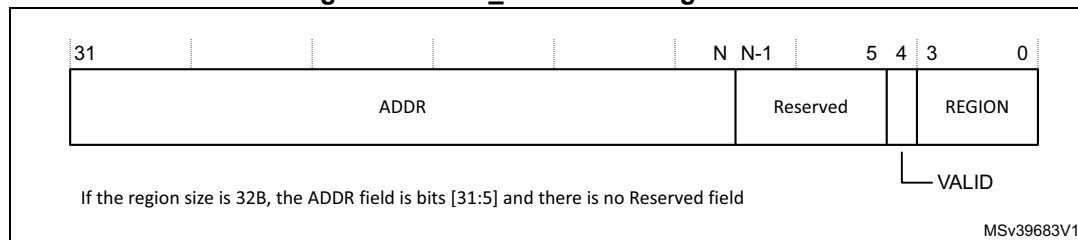

Table 88. MPU_RBAR bit assignments

Bits	Name	Function
[31:N]	ADDR	Region base address field. The value of N depends on the region size. For more information see The ADDR field .
[(N-1):5]	-	Reserved.
[4]	VALID	MPU Region Number valid bit: Write: 0: MPU_RNR not changed, and the processor: Updates the base address for the region specified in the MPU_RNR Ignores the value of the REGION field 1: The processor: Updates the value of the MPU_RNR to the value of the REGION field Updates the base address for the region specified in the REGION field. Always reads as zero.
[3:0]	REGION	MPU region field: For the behavior on writes, see the description of the VALID field. On reads, returns the current region number, as specified by the RNR.

The ADDR field

The ADDR field is bits[31:N] of the MPU_RBAR. The region size, as specified by the SIZE field in the MPU_RASR, defines the value of N:

$$N = \text{Log}_2(\text{Region size in bytes}),$$

If the region size is configured to 4 Gbytes, in the MPU_RASR, there is no valid ADDR field. In this case, the region occupies the complete memory map, and the base address is 0x00000000.

The base address is aligned to the size of the region. For example, a 64KB region must be aligned on a multiple of 64KB, for example, at 0x00010000 or 0x00020000.

4.6.5 MPU region attribute and size register

The MPU_RASR defines the region size and memory attributes of the MPU region specified by the MPU_RNR, and enables that region and any subregions. See the register summary in [Table 84 on page 222](#) for its attributes.

MPU_RASR is accessible using word accesses:

- The most significant halfword holds the region attributes.
- The least significant halfword holds the region size and the region and subregion enable bits.

The bit assignments are:

Figure 52. MPU_RASR bit assignments

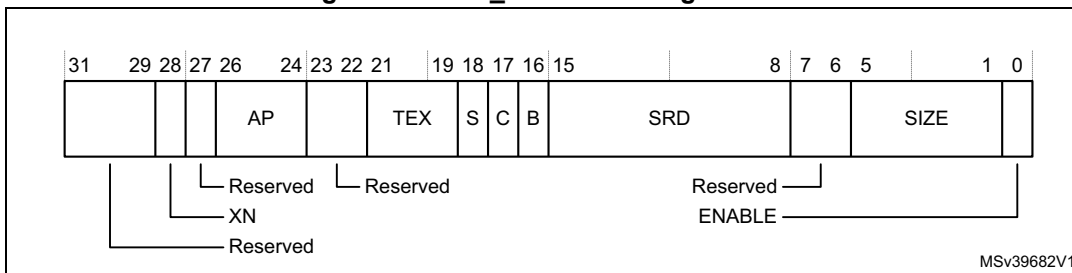

Table 89. MPU_RASR bit assignments

Bits	Name	Function
[31:29]	-	Reserved.
[28]	XN	Instruction access disable bit: 0: Instruction fetches enabled. 1: Instruction fetches disabled.
[27]	-	Reserved.
[26:24]	AP	Access permission field, see Table 93 on page 229 .
[23:22]	-	Reserved.
[21:19, 17, 16]	TEX, C, B	Memory access attributes, see Table 91 on page 228 .
[18]	S	Shareable bit, see Table 91 on page 228 .
[15:8]	SRD	Subregion disable bits. For each bit in this field: 0: Corresponding sub-region is enabled. 1: Corresponding sub-region is disabled. See Subregions on page 231 for more information. Region sizes of 128 bytes and less do not support subregions. When writing the attributes for such a region, write the SRD field as 0x00.
[7:6]	-	Reserved.
[5:1]	SIZE	Specifies the size of the MPU protection region. The minimum permitted value is 4 (0b00100), see SIZE field values for more information.
[0]	ENABLE	Region enable bit.

For information about access permission, see [MPU access permission attributes on page 228](#).

SIZE field values

The SIZE field defines the size of the MPU memory region specified by the RNR. as follows:

$$(\text{Region size in bytes}) = 2^{(\text{SIZE}+1)}$$

The smallest permitted region size is 32B, corresponding to a SIZE value of 4. [Table 90](#) gives example SIZE values, with the corresponding region size and value of N in the MPU_RBAR.

Table 90. Example SIZE field values

SIZE value	Region size	Value of N ⁽¹⁾	Note
0b00100 (4)	32 Bytes	5	Minimum permitted size
0b01001 (9)	1 Kbyte	10	-
0b10011 (19)	1 Mbyte	20	-
0b11101 (29)	1 Gbyte	30	-
0b11111 (31)	4 Gbytes	32	Maximum possible size

1. In the MPU_RBAR, see [MPU region base address register on page 225](#).

4.6.6 MPU access permission attributes

This section describes the MPU access permission attributes. The access permission bits, TEX, C, B, S, AP, and XN, of the RASR, control access to the corresponding memory region. If an access is made to an area of memory without the required permissions, then the MPU generates a permission fault. [Table 91](#) shows encodings for the TEX, C, B, and S access permission bits.

Table 91. TEX, C, B, and S encoding

TEX	C	B	S	Memory type	Shareability	Other attributes	
0b000	0	0	x ⁽¹⁾	Strongly-ordered	Shareable	-	
		1	x ⁽¹⁾	Device	Shareable	-	
	1	0	0	Normal	Not shareable	Outer and inner write-through. No write allocate.	
			1		Shareable		
		1	0	Normal	Not shareable		Outer and inner write-back. No write allocate.
			1		Shareable		
0b001	0	0	Normal	Not shareable	Outer and inner noncacheable.		
				1		Shareable	
		1	x ⁽¹⁾	Reserved encoding		-	
	1	0	x ⁽¹⁾	Implementation defined attributes.		-	
		1	0	Normal	Not shareable	Outer and inner write-back. Write and read allocate.	
			1		Shareable		
0b010	0	0	x ⁽¹⁾	Device	Not shareable	Nonshared Device.	
		1	x ⁽¹⁾	Reserved encoding		-	
	1	x ⁽¹⁾	x ⁽¹⁾	Reserved encoding		-	

Table 91. TEX, C, B, and S encoding (continued)

TEX	C	B	S	Memory type	Shareability	Other attributes
0b1BB	A	A	0	Normal	Not shareable	Cached memory, BB = outer policy, AA = inner policy. See Table 92 on page 229 for the encoding of the AA and BB bits.
			1		Shareable	

1. The MPU ignores the value of this bit.

[Table 92](#) shows the cache policy for memory attribute encodings with a TEX value is in the range 4-7.

Table 92. Cache policy for memory attribute encoding

Encoding, AA or BB	Corresponding cache policy
00	Non-cacheable
01	Write back, write and read allocate
10	Write through, no write allocate
11	Write back, no write allocate

[Table 93](#) shows the AP encodings that define the access permissions for privileged and unprivileged software.

Table 93. AP encoding

AP[2:0]	Privileged permissions	Unprivileged permissions	Description
000	No access	No access	All accesses generate a permission fault
001	RW	No access	Access from privileged software only
010	RW	RO	Writes by unprivileged software generate a permission fault
011	RW	RW	Full access
100	Unpredictable	Unpredictable	Reserved
101	RO	No access	Reads by privileged software only
110	RO	RO	Read only, by privileged or unprivileged software
111	RO	RO	Read only, by privileged or unprivileged software

4.6.7 MPU mismatch

When an access violates the MPU permissions, the processor generates a MemManage fault, see [Exceptions and interrupts on page 28](#). The MMFSR indicates the cause of the fault. See [MemManage fault status register on page 206](#) for more information.

4.6.8 Updating an MPU region

To update the attributes for an MPU region, update the MPU_RNR, MPU_RBAR and MPU_RASR registers. It is possible to program each register separately, or use a multiple-word write to program all of these registers. The MPU_RBAR and MPU_RASR aliases can be used to program up to four regions simultaneously using an STM instruction.

Updating an MPU region using separate words

Simple code to configure one region:

```
; R1 = region number
; R2 = size/enable
; R3 = attributes
; R4 = address
LDR R0,=MPU_RNR           ; 0xE000ED98, MPU region number register
STR R1, [R0, #0x0]       ; Region Number
STR R4, [R0, #0x4]       ; Region Base Address
STRH R2, [R0, #0x8]      ; Region Size and Enable
STRH R3, [R0, #0xA]      ; Region Attribute
```

Disable a region before writing new region settings to the MPU if the region being changed, has been previously enabled. For example:

```
; R1 = region number
; R2 = size/enable
; R3 = attributes
; R4 = address
LDR R0,=MPU_RNR           ; 0xE000ED98, MPU region number register
STR R1, [R0, #0x0]       ; Region Number
BIC R2, R2, #1           ; Disable
STRH R2, [R0, #0x8]      ; Region Size and Enable
STR R4, [R0, #0x4]       ; Region Base Address
STRH R3, [R0, #0xA]      ; Region Attribute
ORR R2, #1               ; Enable
STRH R2, [R0, #0x8]      ; Region Size and Enable
```

The software must use memory barrier instructions:

- Before MPU setup if there might be outstanding memory transfers, such as buffered writes, that might be affected by the change in MPU settings.
- After MPU setup if it includes memory transfers that must use the new MPU settings.

The software does not require any memory barrier instructions during MPU setup, because it accesses the MPU through the PPB, which is a Strongly-ordered memory region.

For example, if it is required that all of the memory access behavior to take effect immediately after the programming sequence, use a DSB instruction and an ISB instruction. A DSB is required after changing MPU settings, such as at the end of context switch. An ISB is required if the code that programs the MPU region or regions is entered using a branch or call. If the programming sequence is entered by taking an exception and the programming sequence is exited by using a return from exception then an ISB instruction is not required.

Updating an MPU region using multi-word writes

The user can program directly using multi-word writes, depending on how the information is divided. Consider the following reprogramming:

```
; R1 = region number
; R2 = address
; R3 = size, attributes in one
LDR R0, =MPU_RNR      ; 0xE000ED98, MPU region number register
STR R1, [R0, #0x0]    ; Region Number
STR R2, [R0, #0x4]    ; Region Base Address
STR R3, [R0, #0x8]    ; Region Attribute, Size and Enable
```

Use an STM instruction to optimize this:

```
; R1 = region number
; R2 = address
; R3 = size, attributes in one
LDR R0, =MPU_RNR      ; 0xE000ED98, MPU region number register
STM R0, {R1-R3}       ; Region Number, address, attribute, size and enable
```

The user can do this in two words for pre-packed information. This means that the MPU_RBAR contains the required region number and had the VALID bit set to 1, see [MPU region base address register on page 225](#). Use this when the data is statically packed, for example in a boot loader:

```
; R1 = address and region number in one
; R2 = size and attributes in one
LDR R0, =MPU_RBAR     ; 0xE000ED9C, MPU Region Base register.
STR R1, [R0, #0x0]    ; Region base address and region number combined
                        ; with VALID (bit 4) set to 1.
STR R2, [R0, #0x4]    ; Region Attribute, Size and Enable.
```

Subregions

Regions of 256 bytes or more are divided into eight equal-sized subregions. Set the corresponding bit in the SRD field of the MPU_RASR to disable a subregion, see [MPU region attribute and size register on page 226](#). The least significant bit of SRD controls the first subregion, and the most significant bit controls the last subregion. Disabling a subregion means another region overlapping the disabled range matches instead. If no other enabled region overlaps the disabled subregion, and the access is unprivileged or the background region is disabled, the MPU issues a fault.

Regions of 32, 64, and 128 bytes do not support subregions. With regions of these sizes, The user must set the SRD field to 0x00, otherwise the MPU behavior is Unpredictable.

Example of SRD use

Two regions with the same base address overlap. Region one is 128 KB, and region two is 512 KB. To ensure the attributes from region one apply to the first 128 KB region, set the SRD field for region two to 0b00000011 to disable the first two subregions, as the figure shows.

Figure 53. Example of disabling subregion

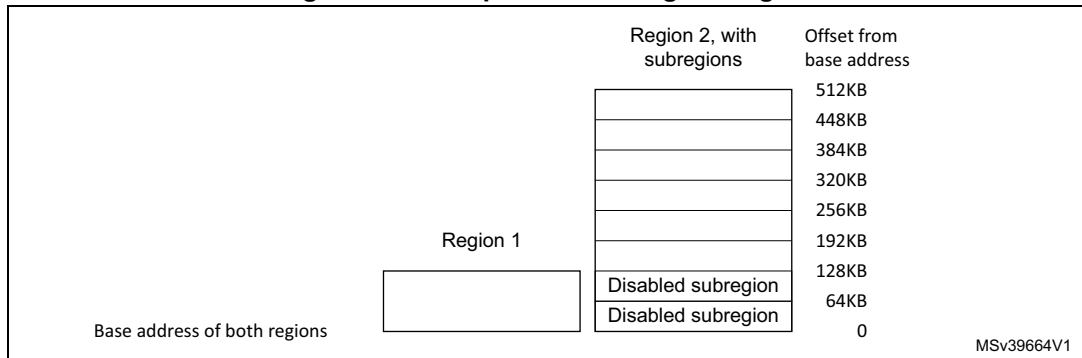

4.6.9 MPU design hints and tips

To avoid an unexpected behavior, disable the interrupts before updating the attributes of a region that the interrupt handlers might access.

The processor does not support unaligned accesses to MPU registers.

The MPU registers support aligned word accesses only. The byte and halfword accesses are unpredictable.

When setting up the MPU, and if the MPU has previously been programmed, disable the unused regions to prevent any previous region settings from affecting the new MPU setup.

4.7 Floating-point unit

The Cortex[®]-M7 *Floating-Point Unit* (FPU) implements the FPv5 floating-point extensions.

The FPU fully supports single-precision and double-precision add, subtract, multiply, divide, multiply and accumulate, and square root operations. It also provides conversions between fixed-point and floating-point data formats, and floating-point constant instructions.

The FPU provides floating-point computation functionality that is compliant with the *ANSI/IEEE Std 754-2008, IEEE Standard for Binary Floating-Point Arithmetic*, referred to as the IEEE 754 standard.

The silicon vendor should also include the following text when implementations support single-precision FPU only. The FPU contains 32 single-precision extension registers, which can be also accessed as 16 doubleword registers for load, store, and move operations.

[Table 94](#) shows the floating-point system registers in the Cortex[®]-M7 processor with FPU.

Table 94. Cortex[®]-M7 floating-point system registers

Address	Name	Type	Required privilege	Reset	Description
0xE00ED88	CPACR	RW	Privileged	0x00000000	Coprocessor access control register on page 233
0xE00EF34	FPCCR	RW	Privileged	0xC0000000	Floating-point context control register on page 234
0xE00EF38	FPCAR	RW	Privileged	-	Floating-point context address register on page 236
-	FPSCR (1)	RW	Unprivileged	-	Floating-point status control register on page 236
0xE00EF3C	FPDSCR	RW	Privileged	0x00000000	Floating-point default status control register on page 237

1. The FPSCR register is not memory-mapped, it can be accessed using the VMSR and VMRS instructions, see [VMRS on page 165](#) and [VMSR on page 166](#). the software can only access the FPSCR when the FPU is enabled, see [Enabling the FPU on page 238](#).

The following sections describe the floating-point system registers whose implementation is specific to this processor.

4.7.1 Coprocessor access control register

The CPACR register specifies the access privileges for coprocessors. See the register summary in [Table 94 on page 233](#) for its attributes. The bit assignments are:

Figure 54. CPACR bit assignments

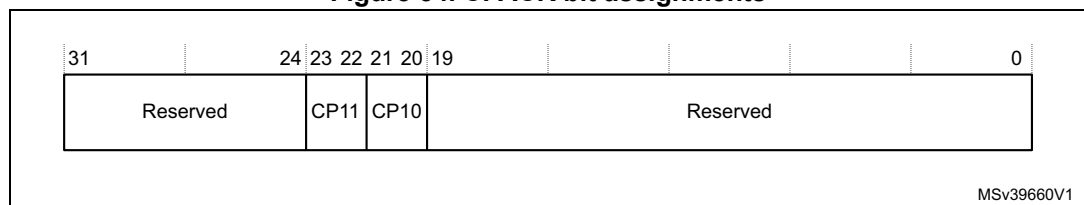

Table 95. CPACR bit assignments

Bits	Name	Function
[31:24]	-	Reserved. Read as Zero, Write Ignore.
[2n+1:2n] for n values 10 and 11	CPn	Access privileges for coprocessor n. The possible values of each field are: 0b00: Access denied. Any attempted access generates a NOCP UsageFault. 0b01: Privileged access only. An unprivileged access generates a NOCP fault. 0b10: Reserved. The result of any access is Unpredictable. 0b11: Full access.
[19:0]	-	Reserved. Read as Zero, Write Ignore.

4.7.2 Floating-point context control register

The FPCCR register sets or returns FPU control data. See the register summary in [Table 94 on page 233](#) for its attributes. The bit assignments are:

Figure 55. FPCCR bit assignments

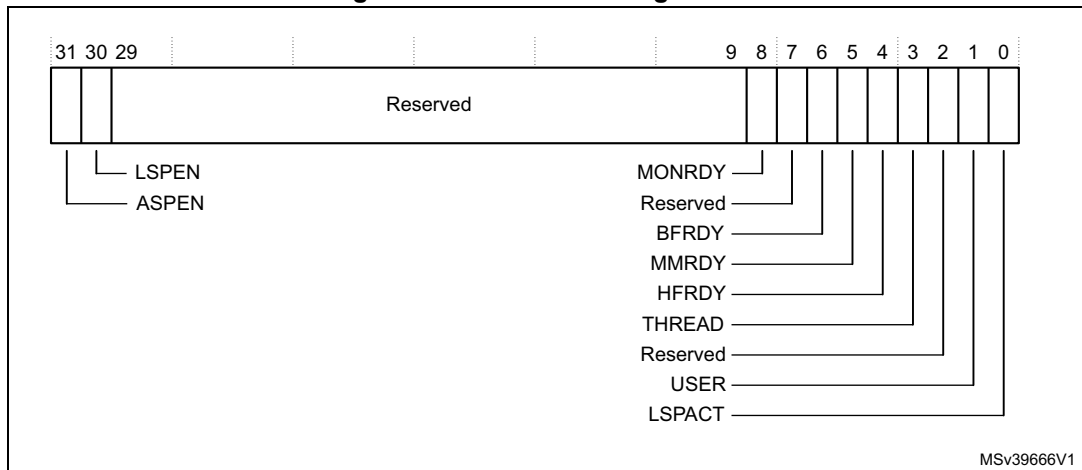

Table 96. FPCCR bit assignments

Bits	Name	Function
[31]	ASPEN	Enables CONTROL.FPCA setting on execution of a floating-point instruction. This results in automatic hardware state preservation and restoration, for floating-point context, on exception entry and exit. 0: Disable CONTROL.FPCA setting on execution of a floating-point instruction. 1: Enable CONTROL.FPCA setting on execution of a floating-point instruction.
[30]	LSPEN	0: Disable automatic lazy state preservation for floating-point context. 1: Enable automatic lazy state preservation for floating-point context.
[29:9]	-	Reserved.

Table 96. FPCCR bit assignments (continued)

Bits	Name	Function
[8]	MONRDY	0: DebugMonitor is disabled or priority did not permit setting MON_PEND when the floating-point stack frame was allocated. 1: DebugMonitor is enabled and priority permits setting MON_PEND when the floating-point stack frame was allocated.
[7]	-	Reserved.
[6]	BFRDY	0: BusFault is disabled or priority did not permit setting the BusFault handler to the pending state when the floating-point stack frame was allocated. 1: BusFault is enabled and priority permitted setting the BusFault handler to the pending state when the floating-point stack frame was allocated.
[5]	MMRDY	0: MemManage is disabled or priority did not permit setting the MemManage handler to the pending state when the floating-point stack frame was allocated. 1: MemManage is enabled and priority permitted setting the MemManage handler to the pending state when the floating-point stack frame was allocated.
[4]	HFRDY	0: Priority did not permit setting the HardFault handler to the pending state when the floating-point stack frame was allocated. 1: Priority permitted setting the HardFault handler to the pending state when the floating-point stack frame was allocated.
[3]	THREAD	0: Mode was not Thread Mode when the floating-point stack frame was allocated. 1: Mode was Thread Mode when the floating-point stack frame was allocated.
[2]	-	Reserved.
[1]	USER	0: Privilege level was not user when the floating-point stack frame was allocated. 1: Privilege level was user when the floating-point stack frame was allocated.
[0]	LSPACT	0: Lazy state preservation is not active. 1: Lazy state preservation is active. Floating-point stack frame has been allocated but saving state to it has been deferred.

4.7.3 Floating-point context address register

The FPCAR register holds the location of the unpopulated floating-point register space allocated on an exception stack frame. See the register summary in [Table 94 on page 233](#) for its attributes. The bit assignments are:

Figure 56. FPCAR bit assignments

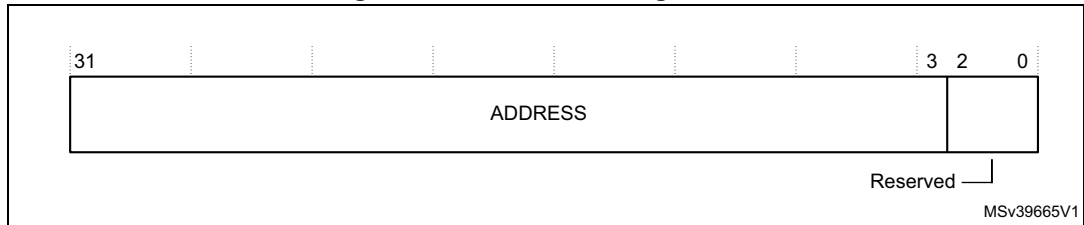

Table 97. FPCAR bit assignments

Bits	Name	Function
[31:3]	ADDRESS	The location of the unpopulated floating-point register space allocated on an exception stack frame.
[2:0]	-	Reserved. Read as Zero, Writes Ignored.

4.7.4 Floating-point status control register

The FPSCR register provides all necessary User level control of the floating-point system. The bit assignments are:

Figure 57. FPSCR bit assignments

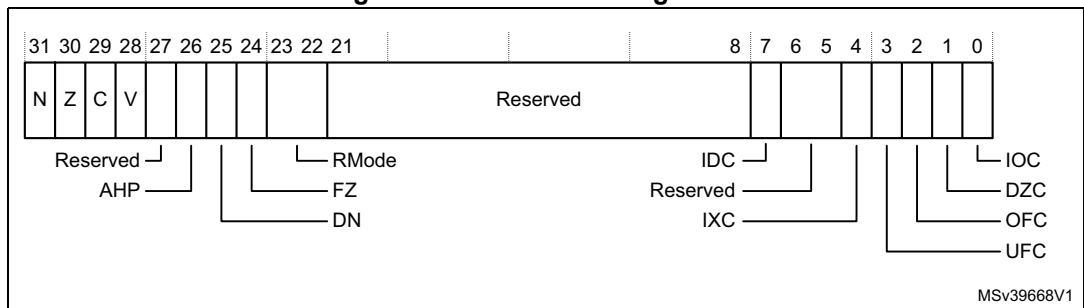

Table 98. FPSCR bit assignments

Bits	Name	Function
[31]	N	Condition code flags. Floating-point comparison operations update these flags. N: Negative condition code flag. Z: Zero condition code flag. C: Carry condition code flag. V: Overflow condition code flag.
[30]	Z	
[29]	C	
[28]	V	
[27]	-	Reserved.
[26]	AHP	Alternative half-precision control bit: 0: IEEE half-precision format selected. 1: Alternative half-precision format selected.

Table 98. FPSCR bit assignments (continued)

Bits	Name	Function
[25]	DN	Default NaN mode control bit: 0: NaN operands propagate through to the output of a floating-point operation. 1: Any operation involving one or more NaNs returns the Default NaN.
[24]	FZ	Flush-to-zero mode control bit: 0: Flush-to-zero mode disabled. Behavior of the floating-point system is fully compliant with the IEEE 754 standard. 1: Flush-to-zero mode enabled.
[23:22]	RMode	Rounding Mode control field. The encoding of this field is: 0b00: <i>Round to Nearest (RN)</i> mode 0b01: <i>Round towards Plus Infinity (RP)</i> mode 0b10: <i>Round towards Minus Infinity (RM)</i> mode 0b11: <i>Round towards Zero (RZ)</i> mode. The specified rounding mode is used by almost all floating-point instructions.
[21:8]	-	Reserved.
[7]	IDC	Input Denormal cumulative exception bit, see bits [4:0].
[6:5]	-	Reserved.
[4]	IXC	Cumulative exception bits for floating-point exceptions, see also bit [7]. Each of these bits is set to 1 to indicate that the corresponding exception has occurred since 0 was last written to it. IDC, bit[7]: Input Denormal cumulative exception bit. IXC: Inexact cumulative exception bit. UFC: Underflow cumulative exception bit. OFC: Overflow cumulative exception bit. DZC: Division by Zero cumulative exception bit. IOC: Invalid Operation cumulative exception bit.
[3]	UFC	
[2]	OFC	
[1]	DZC	
[0]	IOC	

4.7.5 Floating-point default status control register

The FPDSCR register holds the default values for the floating-point status control data. See the register summary in [Table 94 on page 233](#) for its attributes. The bit assignments are:

Figure 58. FPDSCR bit assignments

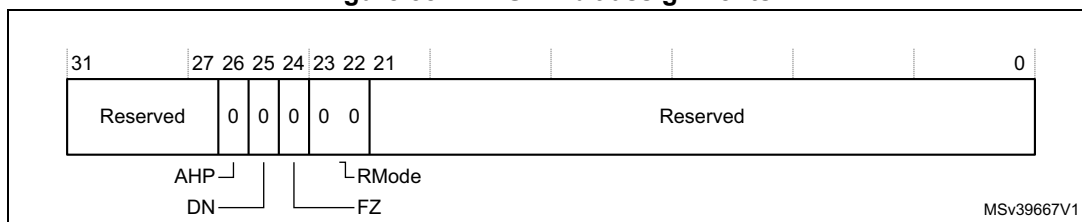

Table 99. FPDSCR bit assignments

Bits	Name	Function
[31:27]	-	Reserved
[26]	AHP	Default value for FPSCR.AHP

Table 99. FPDSCR bit assignments (continued)

Bits	Name	Function
[25]	DN	Default value for FPSCR.DN
[24]	FZ	Default value for FPSCR.FZ
[23:22]	RMode	Default value for FPSCR.RMode
[21:0]	-	Reserved

4.7.6 Enabling the FPU

The FPU is disabled from reset. The user must enable it before using any floating-point instructions. [Example 4-1: Enabling the FPU](#) shows an example code sequence for enabling the FPU in privileged mode. The processor must be in privileged mode to read from and write to the CPACR.

Example 4-1: Enabling the FPU

```

CPACR    EQU    0xE000ED88
LDR      R0,   =CPACR           ; Read CPACR
LDR      r1,  [R0]             ; Set bits 20-23 to enable CP10 and CP11
                                           ; coprocessors

ORR      R1,  R1,  #(0xF << 20)
STR      R1,  [R0]             ; Write back the modified value to the CPACR
DSB
ISB                                           ; Reset pipeline now the FPU is enabled.

```

4.7.7 Enabling and clearing FPU exception interrupts

The FPU exception flags are generating an interrupt through the interrupt controller. The FPU interrupt is globally controlled through the interrupt controller.

There is no individual mask and the enable/disable of the FPU interrupts is done at interrupt controller level. As it occurs very frequently, the IXC exception flag is not connected to the interrupt controller, and cannot generate an interrupt. If needed, it must be managed by polling.

Clearing the FPU exception flags depends on the FPU context save/restore configuration:

- No floating-point register saving: when Floating-point context control register (FPCCR) Bit 30 LSPEN=0 and Bit 31 ASPEN=0.

You must clear interrupt source in Floating-point Status and Control Register (FPSCR).

Example:

```
register uint32_t fpscr_val = 0;
fpscr_val = __get_FPSCR();
{ check exception flags }
fpscr_val &= (uint32_t)~0x8F; // Clear all exception flags
__set_FPSCR(fpscr_val);
```

- Lazy save/restore: when Floating-point context control register (FPCCR) Bit 30 LSPEN=1 and Bit 31 ASPEN=X.

In the case of lazy floating-point context save/restore, a dummy read access should be made to Floating-point Status and Control Register (FPSCR) to force state preservation and FPSCR clear.

Then handle FPSCR in the stack.

Example:

```
register uint32_t fpscr_val = 0;
register uint32_t reg_val = 0;
reg_val = __get_FPSCR(); //dummy access
fpscr_val=*(__IO uint32_t*)(FPU->FPCAR +0x40);
{ check exception flags }
fpscr_val &= (uint32_t)~0x8F ; // Clear all exception flags
*(__IO uint32_t*)(FPU->FPCAR +0x40)=fpscr_val;
__DMB() ;
```

- Automatic floating-point registers save/restore: when Floating-point context control register (FPCCR)

Bit 30 LSPEN=0 and Bit 31 ASPEN=1.

In the case of automatic floating-point context save/restore, a read access should be made to Floating-point Status and Control Register (FPSCR) to force clear.

Then handle FPSCR in the stack.

Example:

```
// FPU Exception handler
void FPU_ExceptionHandler(uint32_t lr, uint32_t sp)
{
register uint32_t fpscr_val;
if(lr == 0xFFFFF9E9)
{
sp = sp + 0x60;
}
else if(lr == 0xFFFFF9ED)
```

```

    {
        sp = __get_PSP() + 0x60 ;
    }
    fpscr_val = *(uint32_t*)sp;
    { check exception flags }
    fpscr_val &= (uint32_t)~0x8F ; // Clear all exception flags
    *(uint32_t*)sp = fpscr_val;
    __DMB() ;
}
// FPU IRQ Handler
void __asm FPU_IRQHandler(void)
{
    IMPORT FPU_ExceptionHandler
    MOV R0, LR // move LR to R0
    MOV R1, SP // Save SP to R1 to avoid any modification to
                // the stack pointer from FPU_ExceptionHandler
    VMRS R2, FPSCR // dummy read access, to force clear
    B FPU_ExceptionHandler
    BX LR
}

```

4.8 Cache maintenance operations

The cache maintenance operations are only accessible by privileged loads and stores. Unprivileged accesses to these registers always generate a BusFault.

Table 100. Cache maintenance space register summary

Address	Name	Type	Required privilege	Reset value	Description
0xE000EF50	ICIALLU	WO	Privileged	Unknown	Instruction cache invalidate all to the <i>Point of Unification</i> (PoU) ⁽¹⁾
0xE000EF54	-	-	-	-	Reserved
0xE000EF58	ICIMVAU	WO	Privileged	Unknown	Instruction cache invalidate by address to the PoU ⁽¹⁾
0xE000EF5C	DCIMVAC	WO	Privileged	Unknown	Data cache invalidate by address to the <i>Point of Coherency</i> (PoC) ⁽²⁾
0xE000EF60	DCISW	WO	Privileged	Unknown	Data cache invalidate by set/way
0xE000EF64	DCCMVAU	WO	Privileged	Unknown	Data cache by address to the PoU ⁽¹⁾
0xE000EF68	DCCMVAC	WO	Privileged	Unknown	Data cache clean by address to the PoC ⁽²⁾
0xE000EF6C	DCCSW	WO	Privileged	Unknown	Data cache clean by set/way
0xE000EF70	DCCIMVAC	WO	Privileged	Unknown	Data cache clean and invalidate by address to the PoC ⁽²⁾
0xE000EF74	DCCISW	WO	Privileged	Unknown	Data cache clean and invalidate by set/way
0xE000EF78	BPIALL	RAZ/WI	Privileged	-	The BPIALL register is not implemented

1. Cache maintenance operations by PoU can be used to synchronize data between the Cortex[®]-M7 data and instruction Caches, for example when the software uses self-modifying code.

- Cache maintenance operations by PoC can be used to synchronize data between the Cortex[®]-M7 data cache and an external agent such as a system DMA.

4.8.1 Full instruction cache operation

The ICIALLU is WO and write data is ignored and reads return 0. Writes to this register perform the requested cache maintenance operation. The BPIALL register is not implemented in the Cortex-M7 processor as branch predictor maintenance is not required. The register is RAZ/WI.

4.8.2 Instruction and data cache operations by address

The cache maintenance operations registers are ICIMVAU, DCIMVAC, DCCMVAU, DCCMVAC, and DCCIMVAC. These registers are WO, reads return 0. See the register summary in [Table 100](#) for their attributes. The bit assignments are:

Table 101. Cache operation registers bit assignments

Bit	Name	Type	Function
[31:0]	MVA	WO	MVA of requested operation

4.8.3 Data cache operations by set-way

The DCISW, DCCSW and DCCISW registers are WO. Reads return 0. See the register summary in [Table 100 on page 240](#) for their attributes. The bit assignments are:

Figure 59. Cache operation bit assignments

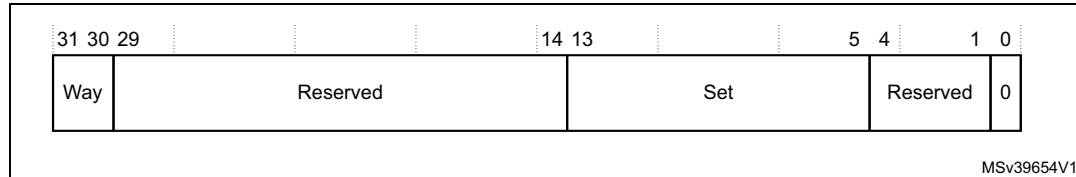

Table 102. Cache operations by set-way bit assignments

Bit	Name	Type	Function
[31:30]	Way	WO	Way that operation applies to. For the data cache, values 0, 1, 2 and 3 are supported.
[29:14]	-	-	Reserved
[13:5]	Set	WO	Set/index that operation applies to. The number of indices in a cache depends on the configured cache size. When this is less than the maximum, use the LSB of this field. The number of sets in the cache can be determined by reading the Cache size ID register on page 219 .
[4:1]	-	-	Reserved
[0]	-	-	Always reads as zero.

4.8.4 Cortex[®]-M7 cache maintenance operations using CMSIS

CMSIS functions enable the software portability between different Cortex[®]-M profile processors. To access cache maintenance operations when using CMSIS, use the following functions:

Table 103. CMSIS access cache maintenance operations

CMSIS function	Descriptions
<code>void SCB_EnableICache(void)</code>	Invalidate and then enable instruction cache
<code>void SCB_DisableICache(void)</code>	Disable instruction cache and invalidate its contents
<code>void SCB_InvalidateICache(void)</code>	Invalidate instruction cache
<code>void SCB_EnableDCache(void)</code>	Invalidate and then enable data cache
<code>void SCB_DisableDCache(void)</code>	Disable data cache and then clean and invalidate its contents
<code>void SCB_InvalidateDCache(void)</code>	Invalidate data cache
<code>void SCB_CleanDCache(void)</code>	Clean data cache
<code>void SCB_CleanInvlaidateDCache(void)</code>	Clean and invalidate data cache

4.8.5 Initializing and enabling the L1-cache

The user can use cache maintenance operations for:

- Cache startup type operations.
- Manipulating the caches so that shared data is visible to other bus masters.
- Enabling data changed by an external DMA agent to be made visible to the Cortex[®]-M7 processor.

After enabling or disabling the instruction cache, the user must issue an ISB instruction to flush the pipeline. This ensures that all subsequent instruction fetches see the effect of enabling or disabling the instruction cache.

After reset, the user must invalidate each cache before enabling it.

When disabling the data cache, the user must clean the entire cache to ensure that any dirty data is flushed to external memory.

Before enabling the data cache, the user must invalidate the entire data cache if external memory might have changed since the cache was disabled.

Before enabling the instruction cache, the user must invalidate the entire instruction cache if external memory might have changed since the cache was disabled.

L1 data and instruction cache must be invalidated before they are enabled in the software, otherwise unpredictable behavior can occur.

Invalidate the entire data cache

The software can use the following code example to invalidate the entire data cache, if it has been included in the processor. The operation is carried out by iterating over each line of the cache and using the DCISW register in the *Private Peripheral Bus* (PPB) memory region to

invalidate the line. The number of cache ways and sets is determined by reading the CCSIDR register.

```

CCSIDR EQU 0xE000ED80
CSSELR EQU 0xE000ED84
DCISW EQU 0xE000EF60
MOV r0, #0x0
LDR r11, =CSSELR
STR r0, [r11] ; Select Data Cache size
DSB
LDR r11, =CCSIDR
LDR r2, [r11] ; Cache size identification
AND r1, r2, #0x7 ; Number of words in a cache line
ADD r7, r1, #0x4
MOV r1, #0x3ff
ANDS r4, r1, r2, LSR #3
MOV r1, #0x7fff
ANDS r2, r1, r2, LSR #13
CLZ r6, r4
LDR r11, =DCISW
inv_loop1
MOV r1, r4
inv_loop2
LSL r3, r1, r6
LSL r8, r2, r7
ORRr 3, r3, r8
STR r3, [r11] ; Invalidate D-cache line
SUBS r1, r1, #0x1
BGE inv_loop2
SUBS r2, r2, #0x1
BGE inv_loop1
DSB
ISB

```

Invalidate instruction cache

The user can use the following code example to invalidate the entire instruction cache, if it has been included in the processor. The operation is carried out by writing to the ICIALLU register in the PPB memory region.

```

ICIALLU EQU 0xE000EF50
MOV r0, #0x0
LDR r11, =ICIALLU
STR r0, [r11]
DSB
ISB

```

Enabling data and instruction caches

The user can use the following code example to enable the data and instruction cache after they have been initialized. The operation is carried out by modifying the CCR.IC and CCR.DC fields in the PPB memory region.

```
CCR      EQU 0xE000ED14
        LDR r11, =CCR
        LDR r0, [r11]
        ORR r0, r0, #0x1:SHL:16    ; Set CCR.DC field
        ORR r0, r0, #0x1:SHL:17    ; Set CCR.IC field
        STR r0, [r11]
        DSB
        ISB
```

4.8.6 Faults handling considerations

Cache maintenance operations can result in a BusFault. Such fault events are asynchronous.

This type of BusFault:

- Does not cause escalation to HardFault where a BusFault handler is enabled.
- Never causes lockup.

Because the fault event is asynchronous, the software code for cache maintenance operations should use memory barrier instructions, such as DSB, on completion so that the fault event can be observed immediately.

4.8.7 Cache maintenance design hints and tips

The user must always place a DSB and ISB instruction sequence after a cache maintenance operation to ensure that the effect is observed by any following instructions in the software.

When using a cache maintenance operation by address or set/way a DSB instruction must be executed after any previous load or store, and before the maintenance operation, to guarantee that the effect of the load or store is observed by the operation. For example, if a store writes to the address accessed by a DCCMVAC the DSB instruction guarantees that the dirty data is correctly cleaned from the data cache.

When one or more maintenance operations have been executed, use of a DSB instruction guarantees that they have completed and that any following load or store operations executes in order after the maintenance operations.

Cache maintenance operations always complete in-order with respect to each other. This means only one DSB instruction is required to guarantee the completion of a set of maintenance operations.

The following code sequence shows how to use cache maintenance operations to synchronize the data and instruction caches for self-modifying code. The sequence is entered with <Rx> containing the new 32-bit instruction. Use STRH in the first line instead of STR for a 16-bit instruction:

```
STR <Rx>, <inst_address1>
DSB                                     ; Ensure the data has been written to the
                                       ; cache.
```

```

STR <inst_address1>, DCCMVAU ; Clean data cache by MVA to point of
                               ; unification (PoU).
STR <inst_address1>, ICIMVAU ; Invalidate instruction cache by MVA to
                               ; PoU.
DSB                            ; Ensure completion of the invalidations.
ISB                            ; Synchronize fetched instruction stream.

```

4.9 Access control

Control of the L1-cache ECC and attribute override, the priority of AHB slave traffic, and whether an access is mapped to TCM interfaces or AXI master interface, is defined by the access control registers. The access control registers are:

Table 104. Access control register summary

Address	Name	Type	Required privilege	Reset value	Description
0xE000EF90	ITCMCR	RW	Privileged	0x00000000	Instruction and data tightly-coupled memory control registers on page 246
0xE000EF94	DTCMCR	RW	Privileged	0x00000000	
0xE000EF98	AHBPCR	RW	Privileged	0x00000000	AHBP control register on page 248
0xE000EF9C	CACR	RW	Privileged	-(¹)	Auxiliary cache control register on page 249
0xE000EFA0	AHBSCR	RW	Privileged	0x00000800	AHB slave control register on page 250
0xE000EFA8	ABFSR	RW	Privileged	0x00000000	Auxiliary bus fault status register on page 251

1. The reset value is implementation and configuration dependent and the silicon vendor changes this. If cache ECC is configured the reset value is 0x00000000, if cache ECC is not configured the reset value is 0x00000002.

4.9.1 Instruction and data tightly-coupled memory control registers

The ITCMCR and DTCMCR control whether access is mapped to the TCM interfaces or the AXI master interface. The bit assignments are:

Figure 60. ITCMCR and DTCMCR bit assignments

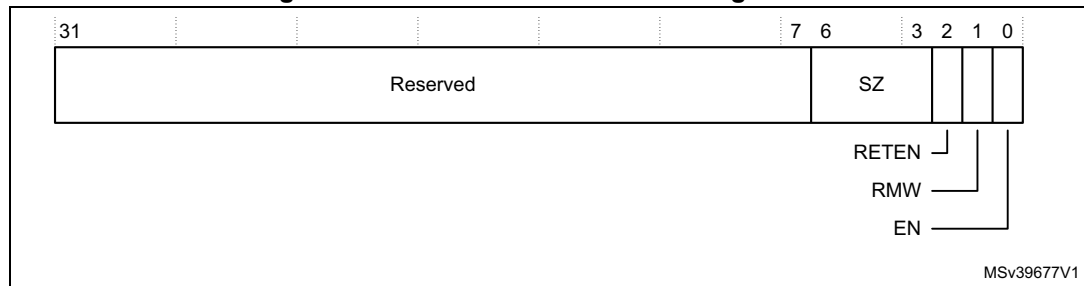

Table 105. ITCMCR and DTCMCR bit assignments

Bits	Name	Type	Function
[31:7]	-	-	Reserved, RAZ/WI.
[6:3]	SZ	RO	TCM size. Indicates the size of the relevant TCM: 0b0000: No TCM implemented. 0b0011: 4KB. 0b0100: 8KB. 0b0101: 16KB. 0b0110: 32KB. 0b0111: 64KB. 0b1000: 128KB. 0b1001: 256KB. 0b1010: 512KB. 0b1011: 1MB. 0b1100: 2MB. 0b1101: 4MB. 0b1110: 8MB. 0b1111: 16MB. All other encodings are reserved.
[2]	RETEN ⁽¹⁾	RW	Retry phase enable. When enabled the processor guarantees to honor the retry output on the corresponding TCM interface: 0: Retry phase disabled. 1: Retry phase enabled.
[1]	RMW ⁽²⁾	RW	<i>Read-Modify-Write (RMW)</i> enable. Indicates that all sub-chunk writes to a given TCM use a RMW sequence: 0: RMW disabled. 1: RMW enabled.
[0]	EN	RW	TCM enable. When a TCM is disabled all accesses are made to the AXI master. 0: TCM disabled. 1: TCM enabled.

1. The RETEN field in the ITCMCR and DTCMCR is used to support error detection and correction in the TCM.

2. The RMW field in the ITCMCR and DTCMCR is used to support error detection and correction in the TCM.

Enabling the TCM

The TCM interfaces can be enabled at reset in the system by an external signal on the processor. If they are disabled at reset then the following code example can be used to enable both the instruction and data TCM interfaces in software:

```
ITCMCR EQU 0xE000EF90
DTCMCR EQU 0xE000EF94

    LDR r11, =ITCMCR
    LDR r0, [r11]
    ORR r0, r0, #0x1      ; Set ITCMCR.EN field
    STR r0, [r11]

    LDR r11, =DTCMCR
    LDR r0, [r11]
    ORR r0, r0, #0x1      ; Set DTCMCR.EN field
    STR r0, [r11]

    DSB
    ISB
```

Enabling the TCM retry and read-modify-write

If the TCM connected to the processor supports error detection and correction, the TCM interface should be configured to support the retry and read-modify-write features. These can be enabled at reset in the system by external signals on the processor. If they are disabled at reset then the following code example can be used to enable them in software:

```
ITCMCR EQU 0xE000EF90
DTCMCR EQU 0xE000EF94

    LDR r11, =ITCMCR
    LDR r0, [r11]
    ORR r0, r0, #0x1:SHL:1 ; Set ITCMCR.RMW field
    ORR r0, r0, #0x1:SHL:2 ; Set ITCMCR.RETEN field
    STR r0, [r11]

    LDR r11, =DTCMCR
    LDR r0, [r11]
    ORR r0, r0, #0x1:SHL:1 ; Set DTCMCR.RMW field
    ORR r0, r0, #0x1:SHL:2 ; Set DTCMCR.RETEN field
    STR r0, [r11]

    DSB
    ISB
```

4.9.2 AHBP control register

The AHBPCR controls accesses to the device on the AHBP or AXI master interface. The bit assignments are:

Figure 61. AHBPCR bit assignments

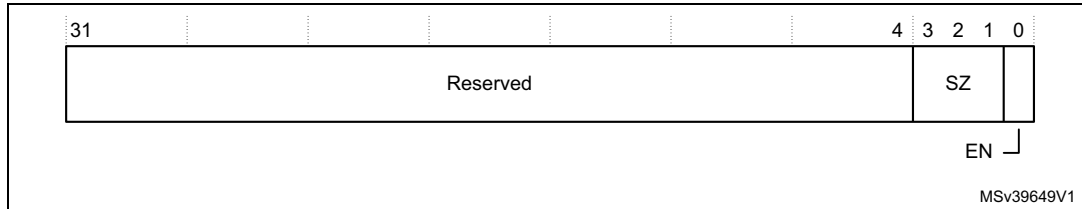

Table 106. AHBPCR bit assignments

Bits	Name	Type	Function
[31:4]	-	-	Reserved, RAZ/WI.
[3:1]	SZ	RO	AHBP size: 0b001: 64 MBytes. 0b010: 128 MBytes. 0b011: 256 MBytes. 0b100: 512 MBytes.
[0]	EN	RW	AHBP enable: 0: AHBP disabled. When disabled all accesses are made to the AXI master. 1: AHBP enabled.

Enabling the AHBP interface

The AHBP interface can be enabled at reset in the system by an external signal on the processor. If it is disabled at reset then the following code example can be used to enable the AHPB interface from software:

```
AHBPCR EQU 0xE000EF98

LDR r11, =AHBPCR
LDR r0, [r11]
ORR r0, r0, #0x1 ; Set AHBPCR.EN field
STR r0, [r11]

DSB
ISB
```

4.9.3 Auxiliary cache control register

The CACR controls the L1-cache ECC and attribute override. The bit assignments are:

Figure 62. CACR bit assignments

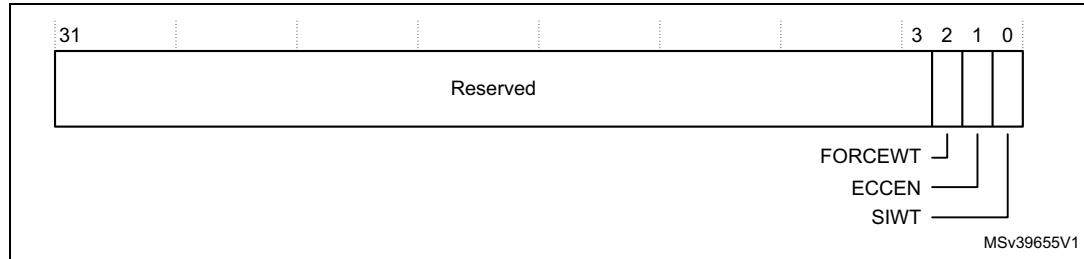

Table 107. CACR bit assignments

Bits	Name	Type	Function
[31:3]	-	-	Reserved, RAZ/WI.
[2]	FORCEWT	RW	Enables Force Write-through in the data cache: 0: Disables Force Write-Through. 1: Enables Force Write-Through. Cacheable Write-Back memory regions are treated as Write-Through. This bit is RAZ if the data cache is excluded.
[1]	ECCEN	RW	Enables ECC in the instruction and data cache: 0: Enables ECC in the instruction and data cache. 1: Disables ECC in the instruction and data cache. This bit is WI if both data cache and instruction cache are excluded or if ECC is not configured. If ECC is included in the processor the reset value of ECCEN is 0. If ECC is excluded the reset value of ECCEN is 1
[0]	SIWT	RW	Enables cache coherency usage: 0: Normal Cacheable Shared locations are treated as being Non-cacheable. Programmed inner cacheability attributes are ignored. This is the default mode of operation for Shared memory. Caches are transparent to software for these locations and therefore no software maintenance is required to maintain coherency. 1: For the data cache, Normal Cacheable shared locations are treated as Write-through. For the instruction cache, shared locations are treated as being Non-cacheable. Programmed inner cacheability attributes are ignored. All writes are globally visible. Other memory agent updates are not visible to Cortex®-M7 software without suitable cache maintenance. Useful for heterogeneous MP-systems where, for example, Cortex®-M7 processor is integrated on the <i>Accelerator Coherency Port (ACP)</i> interface on an MP-capable processor. This bit is RAZ if the data cache is excluded.

Disabling cache error checking and correction

If the cache error checking and correction is included in the processor it is enabled by default from reset. The following code example can be used to disable the feature. The operation is carried out by modifying the CACR.ECCEN field in the PPB memory region.

```

CACR    EQU 0xE000EF9C
        LDR r11, =CACR
        LDR r0, [r11]
        BFC r0, #0x1, #0x1    ; Clear CACR.ECCEN
        STR r0, [r11]

        DSB
        ISB
    
```

Care must be taken when the software changes CACR.ECCEN. If CACR.ECCEN changes when the caches contain data, ECC information in the caches might not be correct for the new setting, resulting in unexpected errors and data loss. Therefore the software must only change CACR.ECCEN when both caches are turned off and both caches must be invalidated after the change.

4.9.4 AHB slave control register

The AHBSCR is used by software to control the priority of AHB slave traffic. The bit assignments are:

Figure 63. AHBSCR bit assignments

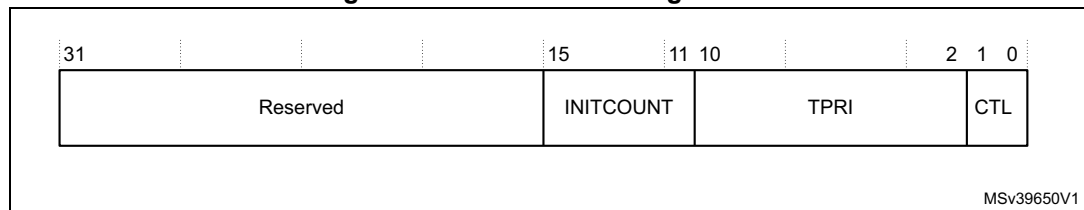

Table 108. AHBSCR bit assignments

Bits	Name	Type	Function
[31:16]	-	-	Reserved.
[15:11]	INITCOUNT	RW	Fairness counter initialization value. Use to demote access priority of the requestor selected by the AHBSCR.CTL field. The reset value is 0b01. For round-robin mode set INITCOUNT to 0b01 and AHBSCR.CTL to 0b00 or 0b01. INITCOUNT must not be set to 0b00 because the demoted requestor always takes priority when contention occurs, which can lead to livelock. INITCOUNT is not used when AHBSCR.CTL is 0b11.

Table 108. AHBSCR bit assignments (continued)

Bits	Name	Type	Function
[10:2]	TPRI	RW	Threshold execution priority for AHBS traffic demotion. 0b0xxxxxxx: Priority is TPRI[7:0]. This is the same as the NVIC register encodings. 0b11111111: Priority of -1. This is the priority of the HardFault exception. 0b11111110: Priority of -2. This is the priority of the NMI exception.
[1:0]	CTL	RW	AHBS prioritization control: 0b00: AHBS access priority demoted. This is the reset value. 0b01: Software access priority demoted. 0b10: AHBS access priority demoted by initializing the fairness counter to the AHBSCR.INITCOUNT value when the software execution priority is higher than or equal to the threshold level programmed in AHBSCR.TPRI. When the software execution priority is below this value, the fairness counter is initialized with 1 (round-robin). The threshold level encoding matches the NVIC encoding and uses arithmetically larger numbers to represent lower priority. 0b11: AHBSPRI signal has control of access priority.

4.9.5 Auxiliary bus fault status register

The ABFSR stores information on the source of asynchronous bus faults. The ASBFSR bit assignments are:

Figure 64. ABFSR bit assignments

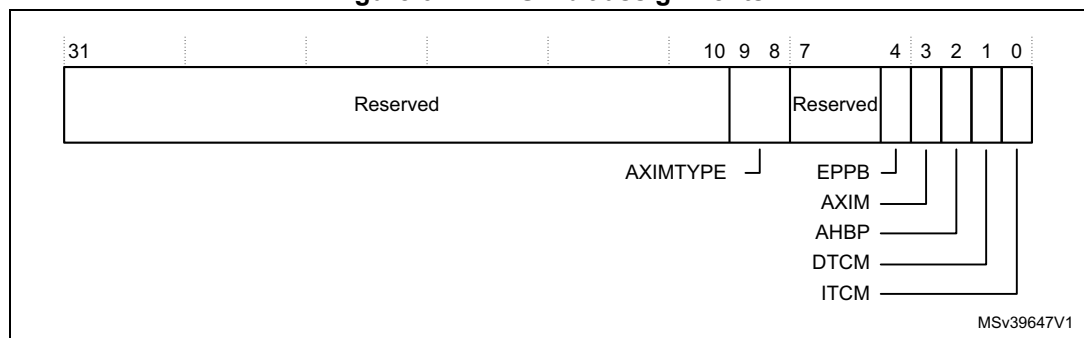

Table 109. ABFSR bit assignments

Bits	Name	Function
[31:10]	-	Reserved
[9:8]	AXIMTYPE	Indicates the type of fault on the AXIM interface: b00: OKAY b01: EXOKAY b10: SLVERR b11: DECERR Only valid when AXIM is 1.
[7:5]	-	Reserved
[4]	EPPB	Asynchronous fault on EPPB interface.

Table 109. ABFSR bit assignments (continued)

Bits	Name	Function
[3]	AXIM	Asynchronous fault on AXIM interface.
[2]	AHBP	Asynchronous fault on AHBP interface.
[1]	DTCM	Asynchronous fault on DTCM interface.
[0]	ITCM	Asynchronous fault on ITCM interface

In the bus-fault handler, the software reads the BFSR, and if an asynchronous fault occurs, the ABFSR is read to determine which interfaces are affected. The ABFSR[4:0] fields remains valid until cleared by writing to the ABFSR with any value.

For more information about the BFSR, see [BusFault status register on page 207](#).

5 Revision history

Table 110. Document revision history

Date	Revision	Changes
18-Dec-2015	1	Initial release.
22-Apr-2016	2	Updated Table 11: STM32F746xx/STM32F756xx Cortex[®]-M7 configuration title. Added Table 12: STM32F76xxx/STM32F77xxx Cortex[®]-M7 configuration . In Section 2.3.2: Memory system ordering of memory accesses updated link to section 2.3.4: <i>software ordering of memory accesses</i> .
02-Feb-2017	3	Added Table 13: STM32F72xxx/STM32F73xxx Cortex[®]-M7 configuration .
14-Nov-2017	4	Added STM32H7 Series in the whole document. Added Table 14: STM32H7 Series Cortex[®]-M7 configuration .
15-Jun-2019	5	Updated DREGION function description in Table 85: TYPE bit assignments . Added Section 4.7.7: Enabling and clearing FPU exception interrupts .

IMPORTANT NOTICE – PLEASE READ CAREFULLY

STMicroelectronics NV and its subsidiaries (“ST”) reserve the right to make changes, corrections, enhancements, modifications, and improvements to ST products and/or to this document at any time without notice. Purchasers should obtain the latest relevant information on ST products before placing orders. ST products are sold pursuant to ST’s terms and conditions of sale in place at the time of order acknowledgement.

Purchasers are solely responsible for the choice, selection, and use of ST products and ST assumes no liability for application assistance or the design of Purchasers’ products.

No license, express or implied, to any intellectual property right is granted by ST herein.

Resale of ST products with provisions different from the information set forth herein shall void any warranty granted by ST for such product.

ST and the ST logo are trademarks of ST. For additional information about ST trademarks, please refer to www.st.com/trademarks. All other product or service names are the property of their respective owners.

Information in this document supersedes and replaces information previously supplied in any prior versions of this document.

© 2019 STMicroelectronics – All rights reserved